

Original Operating Manual

Automatic calf feeder

Type COMPACT smart 2.00 Combi

TAK5-CS2-25

Program version 2.00 and higher



Table of contents

1. Introduction	7
1.1 Automatic feeder	7
1.2 Overview of the automatic feeder	8
1.2.1 Front and right side view of automatic feeder	8
1.2.2 Left side view of the automatic feeder	9
1.2.3 Heat exchanger with separate heating circuits for milk and water	11
1.3 Technical data	11
1.3.1 Electrical connection	11
1.3.2 Dimensions	12
1.3.3 Weight	12
1.3.4 Water connection	12
1.3.5 Milk connection	12
1.3.6 Heat exchanger	13
1.3.7 Boiler	13
1.3.8 Milk powder container	13
1.3.9 Number of feeding stations and animals	13
1.4 Abbreviations	13
1.5 Manufacturer's contact details	14
2. Important safety instructions	16
2.1 Intended use	16
2.2 Your requirements	16
2.3 Residual risks	16
2.4 Your duties	18
2.5 How am I warned of hazards?	18
2.5.1 What are the components of a hazard description?	19
2.5.2 Potentially fatal hazards or health hazards	19
2.5.3 Material damage	19
2.5.4 Safety signs	20
2.6 Safety devices	22
3. Hygiene	24
4. Operation	25
4.1 The Auto LED	25
4.2 Offline mode	25
4.3 Automatic mode	25
4.4 Hand terminal	26
4.4.1 The keypad	27
4.4.2 Data backup	28
4.5 Menu structure	29
4.5.1 Symbols	29
4.6 Menus	31
4.6.1 Animal control	31

4.6.2	Main menu	32
4.6.3	Manual functions.	32
5.	Operation	34
5.1	Feeder operating modes	34
5.1.1	Rationed mode	34
5.1.2	Ad lib mode (emergency mode)	34
5.2	Cloud.	35
5.3	Routine tasks	36
6.	Cleaning	37
6.1	Cleaning with cleaning agents	37
6.1.1	Preparing for cleaning.	38
6.1.2	Cleaning with a cleaning agent.	39
6.1.3	Cleaning with two cleaning agents	45
6.1.4	Clean the cleaning agent pump and the cleaning agent lance.	50
6.2	Cleaning without cleaning agents	52
6.2.1	Preparing for cleaning.	52
6.2.2	Cleaning the heat exchanger manually with a sponge	53
6.2.3	Drain the hoses.	54
6.2.4	Cleaning the powder discharge opening	54
6.2.5	Thorough cleaning of the powder container with the dosing unit	55
7.	Transmitter and animal management	58
7.1	Managing the transmitters	58
7.1.1	Basics	58
7.1.2	Creating transmitter numbers	58
7.1.3	Reading transmitter numbers	59
7.1.4	Manually entering transmitter numbers	59
7.1.5	Assigning animal numbers	59
7.1.6	Editing transmitters or animal numbers	60
7.1.7	Deleting the transmitter number when canceling an animal.	61
7.1.8	Calling up the transmitter statistics.	62
7.2	Registering animals	62
7.2.1	Manual registration of animals	62
7.2.2	Automatically registering animals	63
7.3	Canceling animals or animal groups.	64
7.3.1	Canceling individual animals	64
7.3.2	Canceling a group.	65
7.3.3	Canceling weaned animals.	65
7.4	Changing the registration of animals	65
8.	Feeding	66
8.1	Replenishing feed	66
8.1.1	Filling the milk powder container	66
8.1.2	Filling the milk tank.	66

8.2	Feed preparation	67
8.2.1	MP mode or milk mode	67
8.2.2	Feed distribution	69
8.3	Feeding	69
8.3.1	40FIT feeding	69
8.3.2	Interval feeding program	70
8.3.3	Preferred feeding	70
8.3.4	Extra portion	71
8.4	Checking and changing feeding data for individual animals	71
8.4.1	Group membership	71
8.4.2	Feed quantity	72
8.4.3	Feed concentration	72
8.4.4	Milk share	73
8.4.5	Weight	73
8.4.6	Shortening or lengthening total feeding duration	73
8.5	Feeding plans	74
8.5.1	Changing the default quantity plan	74
8.5.2	Changing the default concentration plan	76
8.5.3	Changing the default milk ratio plan	78
8.5.4	Changing the default quantity limitation plan	79
8.6	Winter feeding plan	80
8.7	Alarm level	81
9.	Animal control	83
9.1	Animal list	83
9.2	Entitlement	85
9.3	Alarm	86
9.4	Plan over date	87
9.5	40FIT	88
9.6	Marked	90
9.7	New	91
9.8	Double	92
9.9	Unknown	93
9.10	All	94
9.11	Total consumption	94
9.11.1	Consumption of all calves	94
9.11.2	Consumption of individual calves	94
9.11.3	Prepared feed portions	95
9.11.4	Consumption of a group	95
9.12	Print	95
9.13	Searching for animals	95
10.	Calibration	97
10.1	Calibrating without calibration scales	97
10.2	Calibrating with calibration scales	98

11. Care and maintenance	101
11.1 Safety instructions	101
11.2 Daily care and maintenance tasks	102
11.3 Weekly care and maintenance tasks	103
11.4 Care and maintenance tasks required every 4 months	104
11.4.1 Calibrating feed components	104
11.4.2 Replacing hoses and teats	104
11.5 Annual care and maintenance tasks	104
12. Faults and warnings	105
12.1 Faults	105
12.1.1 Heating up	105
12.1.2 Temperature too high	106
12.1.3 Heat exchanger not filled	107
12.1.4 Shortage of water	107
12.1.5 Emptying the mixer	108
12.1.6 Heating system	109
12.1.7 Boiler temperature sensor	109
12.1.8 Milk valve/circulation valve	110
12.1.9 Calibration	110
12.1.10 Milk empty	111
12.1.11 Supply electrode	111
12.1.12 Station/drain valve	111
12.1.13 Uncontrolled output	112
12.2 Warnings	112
12.2.1 Emptying the mixer	112
12.2.2 Fill up the MP container	113
12.2.3 Milk empty	113
12.2.4 Mixer temperature sensor	114
12.2.5 Identification	114
12.2.6 Unknown transmitter	114
12.2.7 Calibration	115
12.2.8 Calibration scales	115
12.2.9 Circulation pump	115
12.2.10 Duplicate animal number	115
12.2.11 Machine capacity	116
12.2.12 Check the ball valve	116
12.2.13 Check SD card	117
12.3 Other faults and messages	117
12.3.1 Automatic feeder	117
12.3.2 Hand terminal	118
12.3.3 Boot loader	119
12.4 Service messages	119
13. Disposal	120

13.1	Disposing of cleaning agent residues.	120
13.2	Disposing of hoses	120
13.3	Disposing of cables.	120
13.4	Disposal of the hand terminal	120
13.5	Disposal of the processor circuit board.	120
13.6	Disposal of the automatic feeder	121
14.	Appendix	122
14.1	Standard feeding plans.	122
14.2	Basic principle of interval feeding	124
14.3	Milk powder (MP) conversion table.	124
14.4	Materials list	125
14.5	Care and Maintenance schedule / routine work	125
	14.5.1 Important safety instructions.	125
	14.5.2 Maintenance intervals and activities.	126
	Index.	129

1. Introduction

This chapter explains how your automatic feeder is designed and how to run it safely as intended.

- Read the operating manual carefully before commissioning the automatic feeder and ask your service technician to explain anything that is unclear to you before commissioning.
- Do not operate the automatic feeder until you have read and understood the safety chapter (see 2. "Important safety instructions" - 16). Resolve any questions with your service technician before commissioning the feeder.
- The operating manual for the automatic feeder, the operating manuals of all additional equipment to be connected and the safety data sheets for cleaning agents must be kept readily available at all times and passed on to the next user.
- Observe all of the warnings and safety instructions in this operating manual.
- If your automatic feeder has additional equipment, you must also observe the separate operating manuals and the safety warnings and safety instructions for the additional equipment.

1.1 Automatic feeder

Modern calf rearing businesses primarily use feeding systems with individual animal identification functions. Calves are identified via their collar transponders or electronic earmarks and fed based on their individual requirements.

Feed is always prepared fresh and dispensed to calves in small portions at the temperature and concentration that you have specified.

The hand terminal provides quick and easy access to the controls of the automatic feeder when you are right near your animals. You can connect the automatic feeder to your PC and then control the feeder from your computer.

Your advantages:

1. Added functions eliminate cumbersome routine tasks and save you time.
2. Automatic cleaning programs improve feed hygiene.
3. The hand terminal gives you quick access to important animal data.
4. The animal control list provides a clear and easy way of monitoring animals.
5. The automatic feeder offers you a wide range of options for feeding plans and recipes.
6. You can expand the functionality of the automatic feeder by incorporating concentrate feeders and PC programs with graphical analyses.
7. The automatic feeder's rugged and reliable design makes it easier to use in pens.
8. The automatic feeder can be integrated into the feeding systems of well-known dairy equipment manufacturers.

1.2 Overview of the automatic feeder

1.2.1 Front and right side view of automatic feeder

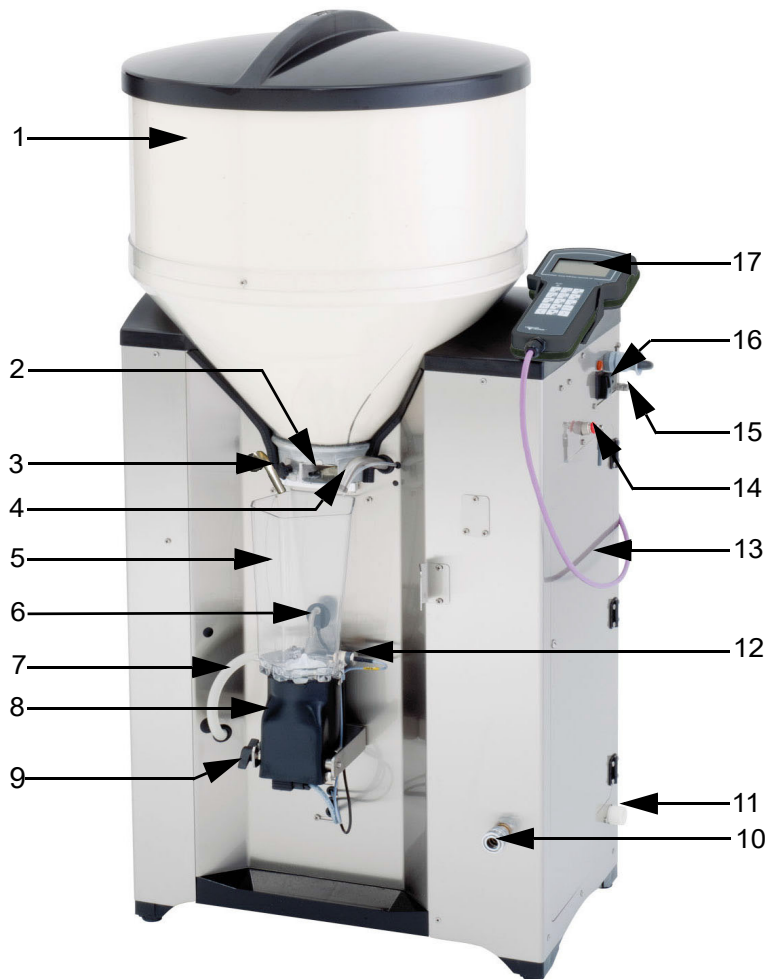

- 1 Milk powder container
- 2 Milk powder discharge
- 3 Water supply
- 4 Milk feed
- 5 Mixer beaker
- 6 Rod electrode
- 7 Hose connection from mixer to the feeding pump
- 8 Mixer motor
- 9 Wing nut for transport restraint
- 10 Milk connection
- 11 Water connection
- 12 Temperature sensor
- 13 Right door
- 14 Nozzle for sponge cleaning
- 15 Ground connection screw
- 16 Control switch
- 17 Hand terminal

1.2.2 Left side view of the automatic feeder

The **Name plate** is located above the left side door on the outside of the automatic feeder. It contains information about the manufacturer, type and number of the automatic feeder, information about connecting the feeder to the power supply as well as its certification. An example of a name plate is shown below.

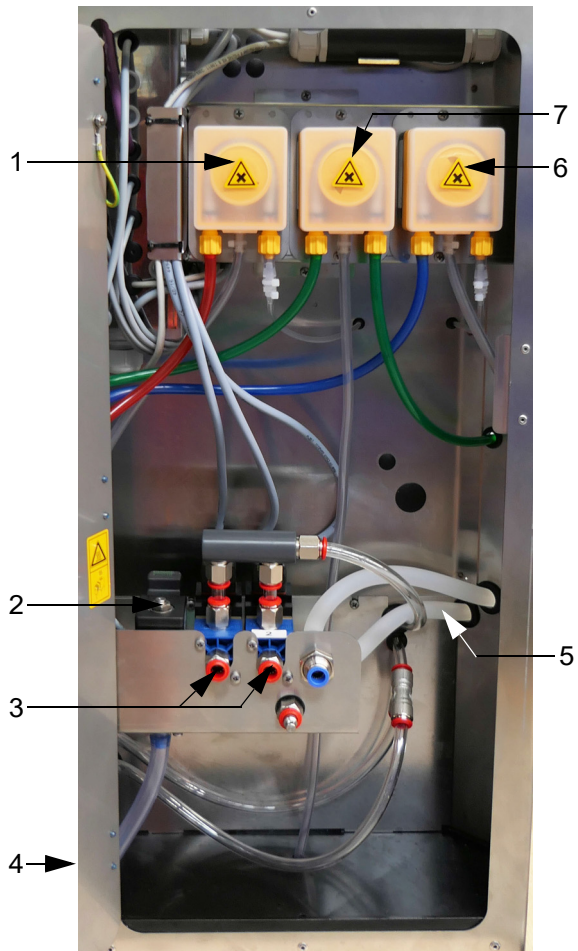

- 1 Name and address of the manufacturer
- 2 Type and number of the automatic feeder
- 3 Information on the connection to the power supply
- 4 Certification of the automatic feeder

Rear left side door

- 1 Cleaning agent dosing pump 2 (acid)
- 2 Mixer drain valve
- 3 Feeding box valves (optional)
- 4 Drain hoses (not shown here)
- 5 Hose connection from mixer to the feeding pump
- 6 Cleaning agent dosing pump 1 (alkaline)
- 7 Dosing device for liquid additives (optional)

1.2.3 Heat exchanger with separate heating circuits for milk and water

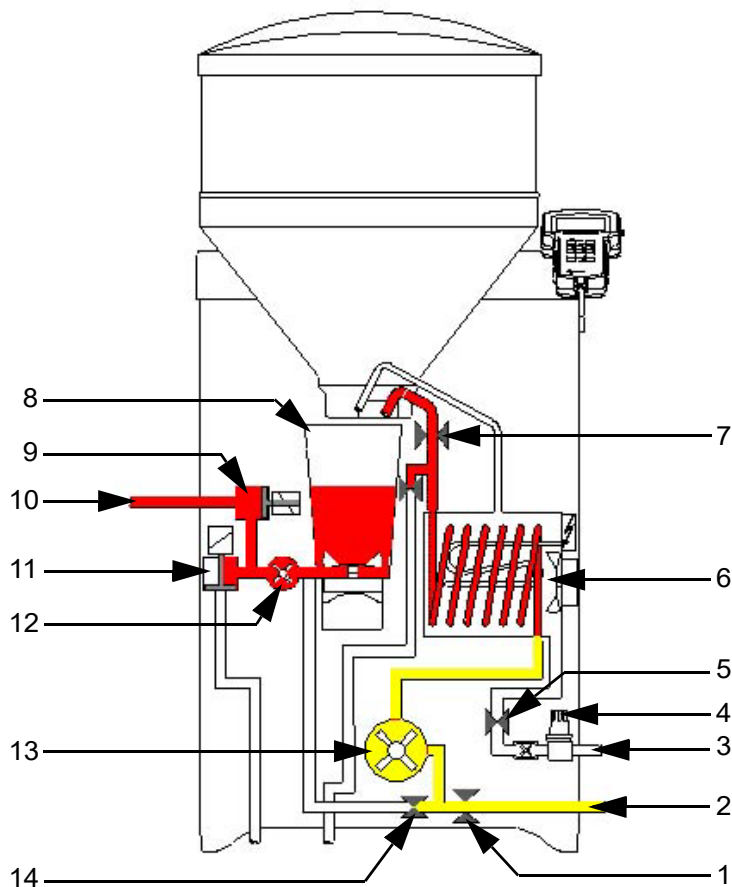

- 1 Milk valve
- 2 Hose connection for milk tank
- 3 Hose connection for water pipe
- 4 Volume control valve
- 5 Boiler water valve
- 6 Heat exchanger with stainless steel coil
- 7 Ball valve
- 8 Mixer
- 9 Valve unit (optional)
- 10 Hose connection between valve unit and teat
- 11 Mixer drain valve
- 12 Feeding pump
- 13 Milk pump
- 14 Circulation valve

1.3 Technical data

1.3.1 Electrical connection

Note: The specifications for the electrical connection to your automatic feeder are on its name plate above the left side door on the outside (see 1.2.2 "Left side view of the automatic feeder" - 9).

1.3.2 Dimensions

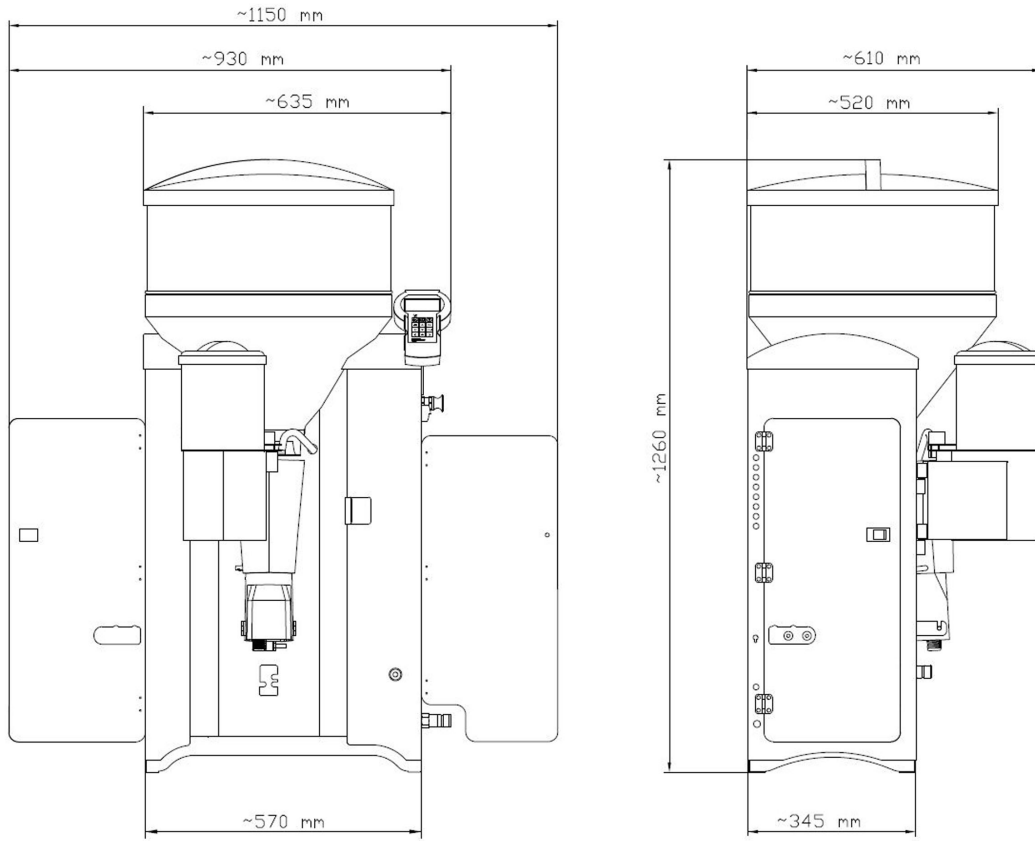

Depth when the fly screen door is opened ~ 690mm

1.3.3 Weight

Approx. 80kg.

1.3.4 Water connection

Water is connected via a 3/4 inch hose and with a 3/4 inch screwed connection.

NOTICE!

The water must be of drinking water quality.

- ▶ Please bear in mind that high calcium, iron and manganese concentrations can cause premature wear of the components. In such cases it makes sense to install appropriate filtration systems.

The water pressure on site must be between 2,5 and 6 bar or between 250000 and 600000 Pascal.

1.3.5 Milk connection

Milk is connected via a 1/2 inch hose and with a 1/2 inch screwed connection.

1.3.6 Heat exchanger

The stainless steel coil holds 0.25 l of milk.

1.3.7 Boiler

The boiler holds approximately 7 ltr of water.

1.3.8 Milk powder container

The milk powder container with attachment holds approximately 35 kg of milk substitute.

1.3.9 Number of feeding stations and animals

Feeding stations:	max. 2
Calves per feeding station	max. 25
Calves per device	max. 50

1.4 Abbreviations

Abbreviation	Meaning
Call ltr. t. or Call t.	Call-off today in liters
Call ltr. y. or Call y.	Call-off yesterday in liters
abs.	absolute
Adli	Ad lib
save amt.	Amount saved up
feed.pump	Feeding pump
out. pause	Dispensing pause
sw.off del.	Switch-off delay
dr. time	Drink-out time
bo	Boiler
dos.	Dosage
EI	Electrode
electrol.	Electrolyte
sw. on del.	Switch-on delay
F	40 FIT feeding
f	40 FIT periods
gradient	Gradient control
gr. A (B)	Group A (B)
IFS KF	Intelligent feeding station concentrate
IV	Interval feeding program
Ball valve	Ball valve
C	Concentrate
Conc. concentr.	Concentration

dra.v. N.	Drain via teat
w. entitle.	With entitlement
w/add. or w/addiv.	With additive
MAP	Manual feeding pump
MP	Milk substitute
max	maximum
milk rat.	Milk share
Min. temp.	Minimum temperature
mix. full	Mixer full
mixer cl.	Cleaning the mixer
mixer dr.valve	Mixer drain valve
n.	not
No.	Number
Clean teat	Clean teat
w/o entitlement	Without entitlement
w/o add. or w/o add.	Without additive
P 1-5	Periods 1-5
R	rationed feeding principle
rel.	relative
Drnk spd.	Drinking speed
ho.	Hose
clo.?	close
det. pump	Flushing agent pump
Temp.	Temperature
TR	Feeding box
fd.sensor	Feeding sensor
Bo. water	Boiler water
HE	Heat exchanger
Incr./Red.	Increase/reduction
add. disp.	Additive dispenser

1.5 Manufacturer's contact details

Please contact us if you have any questions about our products or require technical support. When you contact us, always specify the model, serial number and program version of your automatic feeder so that we can tailor our service to your unit.

The device number and model are located on the name plate on the left of the automatic feeder housing. When commissioning your automatic feeder, ask your service technician for the device number and model.

You can call up the program version via your hand-held terminal. The relevant menu item can be found under  > **Diagnostics** > **Version** > **Device**. When commissioning your automatic feeder, ask your service technician for the version of your program.

You can note the device type, serial number and program version in the fields provided.

Device type:

Serial number:

Program version:

Our contact details:

Förster-Technik GmbH

Gerwigstrasse 25

78234 Engen, Germany

Phone: +49/ (0)7733/ 9406- 0

Fax: +49/ (0)7733/ 9406- 99

info@foerster-technik.de

www.foerster-technik.de

2. Important safety instructions

This chapter outlines:

- The hazards caused by your automatic feeder and how to avoid them.
- The safety labels attached to the automatic feeder and what they mean.
- How to operate the automatic feeder safely.

The automatic feeder is state of the art and is produced in compliance with recognized safety regulations. However, hazards and adverse effects may arise when using it. Both warning signs directly on the automatic feeder and warning notices in this manual provide warning of these hazards.

2.1 Intended use

The automatic feeder may only be used to prepare, heat, and dispense liquid feeds, for example milk, for calves.

2.2 Your requirements

You must have experience in calf rearing, many years of professional experience in agriculture and an excellent command of technical agricultural practice.

You must be familiar with accident prevention regulations and the generally recognized safety regulations.

2.3 Residual risks

Hazards to health caused by the automatic feeder:



WARNING!

Danger from electric current

The automatic feeder is powered by electricity.

► You must observe the general precautions for handling electrical equipment.

- Read the operating manual before operating the automatic feeder.
- Keep children away from the automatic feeder.
- Do not touch any moving parts of the automatic feeder, for example the mixer blades.
- Only use genuine spare parts from the manufacturer.
- Switch off the automatic feeder and disconnect the power plug before carrying out any maintenance or cleaning work on the automatic feeder.
- If you are operating the automatic feeder outside of closed spaces, you must protect it against rain and moisture, for example with a roof.
- Do not operate the automatic feeder outdoors, in the open.
- If there is a connection to a drinking water system, then the system must be protected from back siphoning.

- The following specific hazards are associated with the automatic feeder's electrical system:
 - **Electrical discharge.** If there is an electrical or voltage discharge, electric current flows through parts of the automatic feeder that are normally insulated. Touching the unit can cause a fatal electric shock. The automatic feeder must be checked regularly for electrical safety in compliance with national regulations (repeated inspection). Make sure that a 30 mA residual current device (RCD) is installed.
 - **Short circuit, indirect contact.** If there is a short circuit, current at many times the level of the operating current can flow. Touching the unit can cause a fatal electric shock. Make sure you install a fuse (provided by the customer) corresponding to the rating on the name plate and a 30 mA residual current device (RCD) in compliance with local regulations.
- The solenoid valves and the pipes to the valves can reach temperatures of up to 70°C. Touching it can cause burns. Do not touch the solenoid valves and pipes during operation.
- Liquid at temperatures of up to 70°C can spray out of the pipes to the valves. This can cause scalding. Do not touch the pipes during operation, and allow them to cool down before performing any maintenance or cleaning work. Carry out the recommended maintenance on the hoses.
- The mixer and powder supply may start up unexpectedly if a calf which is entitled to feed approaches the unit. This can crush or chop off fingers or hands. Never reach into the area of the mixer or powder supply while the automatic feeder is in operation. Use only the scraper supplied to clean the powder discharge opening.
- **Poisoning.** Additives that are fed to the calves may contain substances that are hazardous to human health. Avoid direct contact and always wear protective gloves and goggles when handling these substances.
- **Chemical burns.** The cleaning agent used to clean the automatic feeder contains caustic substances. They can cause severe injuries to your hands or eyes. Avoid direct contact and always wear chemical-proof protective gloves and goggles when handling the cleaning agent.
- **Excessive physical strain.** The automatic feeder weighs 80kg. Never attempt to carry it by yourself as this can cause excessive physical strain.

Material damage caused by the automatic feeder

The automatic feeder can cause the following types of material damage:

- **Infection.** Improper cleaning or incorrect operation can result in calves becoming infected by pathogens from the automatic feeder. This can lead to medical costs or cause the death of the calves.
- **Corrosion.** Improper cleaning or maintenance can result in the automatic feeder ceasing to function correctly.
- **Loss of stability.** The automatic feeder must be set up on a level surface. Otherwise, the automatic feeder can tip over and suffer damage.

2.4 Your duties

- Prevent misuse by children.
- Keep children, teenager, physically, sensory and mentally handicapped persons away from the automatic feeder.
- Carefully read the operating manual before starting to use your automatic feeder and ask your service engineer to explain anything that you do not understand before you use it for the first time.
- Follow the health and safety and accident prevention regulations.
- Only operate the automatic feeder at an ambient temperature in the range of 2-40°C. The maximum humidity is 80%.
- Observe the manufacturer's recommendations for the animal feed used.
- When cleaning the automatic feeder, observe the safety instructions stipulated in the safety data sheet for the cleaning agent.
- Wear the safety equipment specified in the safety data sheet for the cleaning agent, such as goggles and chemical-proof protective gloves, when cleaning the automatic feeder.
- Only operate the automatic feeder if it is in faultless condition and is fully functional.
- Only operate the automatic feeder if the safety equipment is fitted and intact.
- Regularly check the fitted safety equipment to ensure that it is working properly. You can find a care and maintenance schedule in the appendix (see 14.5.2 "Maintenance intervals and activities" - 126), which provides recommendations on how often you should check the safety devices.
- Visually inspect the automatic feeder for possible damage. You can find a care and maintenance schedule in the appendix (see 14.5.2 "Maintenance intervals and activities" - 126), which provides recommendations of how often you should check different parts of the automatic feeder.
- Repair any damage to the automatic feeder, or if you are not authorized to or capable of doing this yourself, have it repaired by a service engineer.
- Never carry out any unauthorized modifications to the automatic feeder.
- Keep all safety labels on the automatic feeder in a legible condition. Replace any damaged or illegible safety signs immediately. You can order new safety signs from Förster-Technik GmbH.
- Only use genuine accessories, spare parts, and wearing parts. They are available from your dealer.
- Do not use the automatic feeder at elevations above 5000 metres.

2.5 How am I warned of hazards?

Hazards are indicated directly on the automatic feeder by safety labels (warning signs, instruction and prohibition notices), and in the operating manual by specially marked hazard descriptions.

The warnings for hazards that can cause death or injury to people are emphasized more than those for material damage, for example through the colors, hazard words or symbols used.

Safety labels are an important element of the overall automatic feeder safety concept. They provide warnings about hazards and explain how to avoid them.

Make sure that all the specified safety labels are fitted to your automatic feeder and that they are in a legible condition. If the safety labels are difficult to read, replace them immediately. New safety labels are available from Förster-Technik GmbH.

2.5.1 What are the components of a hazard description?

A hazard description always consists of the following elements:

- Hazard word (danger, warning, caution, attention)
- Type of hazard (what can happen?)
- Location of hazard (where can it happen?)
- Actions necessary for preventing the hazard (what should I do?).

2.5.2 Potentially fatal hazards or health hazards

Depending on their severity and the probability of them occurring, hazards that can cause death or injury to people are indicated by a hazard symbol  (warning triangle with exclamation mark) and the following hazard words:

 **DANGER!**

The word **DANGER** indicates an imminent hazard that will lead to death or serious injury.

Warning signs in the operating manual: **DANGER** (white text on red background).

 **WARNING!**

The word **WARNING** indicates a potentially hazardous situation that could lead to death or serious injury.

Warning signs in the operating manual: **WARNING** (black text on orange background).

 **CAUTION!**

The word **CAUTION** indicates a potentially hazardous situation that could lead to minor injury.

Warning signs in the operating manual: **CAUTION** (black text on yellow background).

2.5.3 Material damage

NOTICE!

The word **NOTICE** indicates possible material damage. The automatic feeder or an object in its vicinity may be damaged, for example a calf.

Prohibition notice on the automatic feeder: a pictogram crossed out in red in a white circle with a red border indicates something you are not allowed to do.

Operating manual: white text on blue background

2.5.4 Safety signs

Different safety notices are attached at the hazardous points on the automatic feeder. Warning signs, prohibition and instruction notices.

What are warning signs?

Warning signs consist of:

- A pictogram in a yellow triangle illustrating the potential hazard.

What are prohibitory signs?



Prohibitory signs have a pictogram of the prohibited action in a red circle with a line through it. See the adjacent example. They graphically depict the prohibited action. In this example, the hose with a line through it means that you may not use high-pressure cleaners.

What are instruction notices?

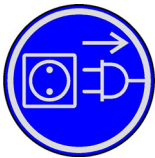

Instruction notices show a pictogram of what you are being instructed to do in a blue circle. They illustrate what you have to do. In the example, the pictogram means that you must always disconnect the plug first.

Other signs

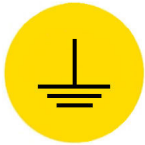

Grounding symbol. This symbol is placed in the locations where you must perform potential equalization.

2.5.4.1 Warning signs on the machine

Danger of death by electric shock

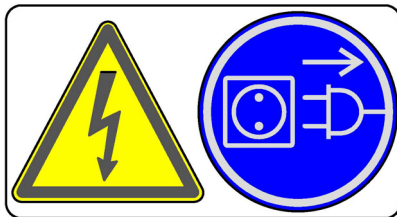

Burning/scalding



Health hazards caused by additives and cleaning agents



Automatic startup



No spraying



Grounding symbol

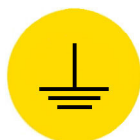

2.6 Safety devices

The automatic feeder may only be operated if the safety equipment is complete and intact. The automatic feeder has the following safety equipment:

- Safety signs (warning signs, instruction and prohibition signs).
- The heater's safety temperature limiter. This shuts down the heater in the event of overheating (temperature rises above 70°C). The heater may only be reactivated by a service engineer.
- Safety grid for the powder hopper attachment. The safety grid prevents people from being injured by the rotating tools in the hopper, for example when adding milk powder. It must always be installed when the unit is operating.
- The scraper next to milk powder discharge. The powder discharge opening may only be cleaned with the scraper. This prevents finger and hand injuries caused by the powder conveyor starting up automatically.

The safety devices at the machine are an important part of the safety concept and help prevent accidents.

- Do not remove or change the safety devices unless the corresponding safety instructions have been complied with.
- Put the machine into service only once all safety devices have been fitted and are in the guard position!

Safety temperature limiter

The automatic feeder's heater is equipped with a safety temperature limiter which will be triggered in the event of overheating (70°C) and which will then shut down the heater.

The safety temperature limiter is triggered if the water gets too hot or if the heater is running dry. The heater may only be reactivated by a service engineer.

Protective grid for powder hopper attachment

The protective grid for the powder hopper attachment prevents you from being injured by the rotating tools in the powder hopper, for example, when filling in milk powder.



1 Protective grid

⚠ WARNING!

There is a risk of injury due to rotating tools.

The safety grid must always be installed when the unit is operating.

Scraper next to the milk powder outlet

The powder discharge opening may only be cleaned with the scraper. This prevents finger and hand injuries caused by the mixer starting up automatically.

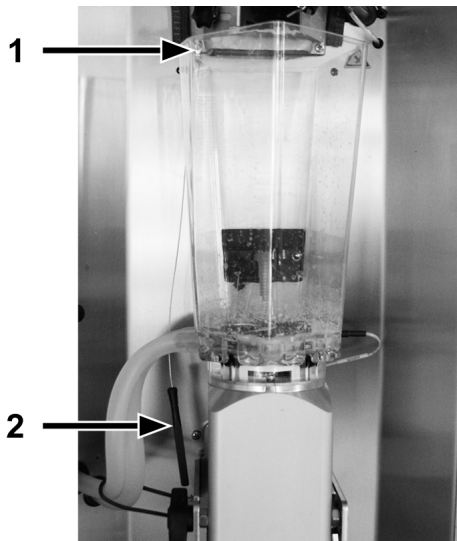

- 1 Mount for scraper
- 2 Scraper

 WARNING!**There is a risk of injury due to automatic start-up**

Do not reach into the hazard area of the powder discharge opening. The powder dosing can start up automatically at any time, crushing or cutting off your fingers.

- ▶ Always switch off the automatic feeder using the control switch and disconnect the mains plug. Use only the scraper supplied to clean the powder discharge opening.

3. Hygiene

As a farmer with experience in calf rearing, you understand how unhygienic conditions affect the health of your calves. Diarrhea and respiratory infections are frequently occurring infectious diseases in calves.

Every sick calf involves additional costs, for example for veterinarians and medication, and requires extra time for care.

The younger the calf, the weaker its immune system, and the more prone to infection it will be.

The possibility of infection can never be completely eliminated, but it can be minimized by taking measures to ensure good hygiene.

Maintaining cleanliness is one important and easy measure that helps prevent infectious diseases.

Through proper cleaning at regular intervals, every calf-rearing business can reduce the risk of infection for its calves and save money as a result.

Measures to ensure hygienic conditions save time and money.

What are infections? An infection occurs when germs invade and multiply in a host.

Germs are all around us. However, they are not dangerous until they multiply in great numbers. The risk of infection increases with the number of germs.

When germs get into your animal feed, such as milk, they can spoil the feed and make it inedible.

When germs get into your calves, for example from infected feed or other infected calves, your calves can become sick and die.

Both situations result in costs that you can minimize by taking measures to ensure hygienic conditions.

As a farmer, it is your job to identify sources of infection and bring them under control.

So how do you prevent infections? By keeping animals in good conditions, with good drinking water and feed quality and, most importantly, through cleanliness.

Proper cleaning is an important way of ensuring hygienic conditions and also prevents infections.

If the automatic feeder is not cleaned or is cleaned improperly, germs, which are abundant in the environment, can enter the nutrient-rich feed and multiply. When they drink the feed, calves can become infected, sick and even die.

Proper cleaning of the automatic feeder reduces the number of germs and therefore the risk of infection.

The cleaning chapter (see 6. "Cleaning" - 37) explains how to clean the automatic feeder properly. The appendix contains a table of suggestions of how to clean the different parts of the automatic feeder (see 14.5.2 "Maintenance intervals and activities" - 126).

4. Operation

This chapter explains how to operate your automatic feeder using the hand terminal.

The hand terminal is directly connected to your automatic feeder by a cable. You switch it on and off together with the automatic feeder. It remains in operation as long as the automatic feeder is switched on.

Note: After the hand terminal has been switched on, the version of the hand terminal's program first briefly appears in the display, before the automatic feeder carries out a test routine. Do not press any buttons on the control panel during these initial routines.

- You monitor and control the automatic feeder (the **feeding pump**, for example) directly via the keys of the hand terminal.
- You monitor and change the settings of the automatic feeder and the values of calves via menus. The menus and sub-menus are arranged so that you can find the necessary settings quickly and easily. With a click of a button, you can access the most important menus, such as **Animal control**, **Main menu** and **Manual functions** as well as the **Animal list**.

You can run the automatic feeder in offline mode or in automatic mode.

4.1 The Auto LED

The LED (light-emitting diode) of the hand terminal displays important information about the status of the automatic feeder:

- In automatic mode, the LED lights up green.
- In offline mode, the LED is not lit up.
- If a malfunction occurs, the LED flashes.

You can run the automatic feeder in offline mode or in automatic mode.

4.2 Offline mode

In offline mode, you perform actions that you cannot do while the unit is in operation, such as the recalibration of feed components. When the automatic feeder switches from automatic to offline mode, the Auto LED goes out.

You switch to offline mode when you open a menu that requires offline mode, such as the calibration menu.

1. In the corresponding menu, press .
2. Confirm the message **Exit automatic mode?** by choosing .

The Auto LED on your hand terminal goes out.

3. Perform the desired action.

4.3 Automatic mode

You perform most routine tasks, such as feeding, in automatic mode. In automatic mode, the Auto LED lights up green.

You exit automatic mode by pressing and confirming the message **Exit automatic mode?** by choosing .

After a prolonged period of inactivity, the automatic feeder automatically returns to automatic mode. This time period is defined during commissioning. A default value of 20 minutes is pre-set.

You switch from offline mode to automatic mode as follows:

1. Press until the message **Start automatic mode?** appears in your display.

You are now in automatic mode again. The Auto LED lights up green.

2. Press .

You are now in automatic mode again. The Auto LED lights up green.

4.4 Hand terminal

The hand terminal is directly connected to the automatic feeder by a cable. The lighting of the display switches off when the unit is not used for a long period. This saves power.

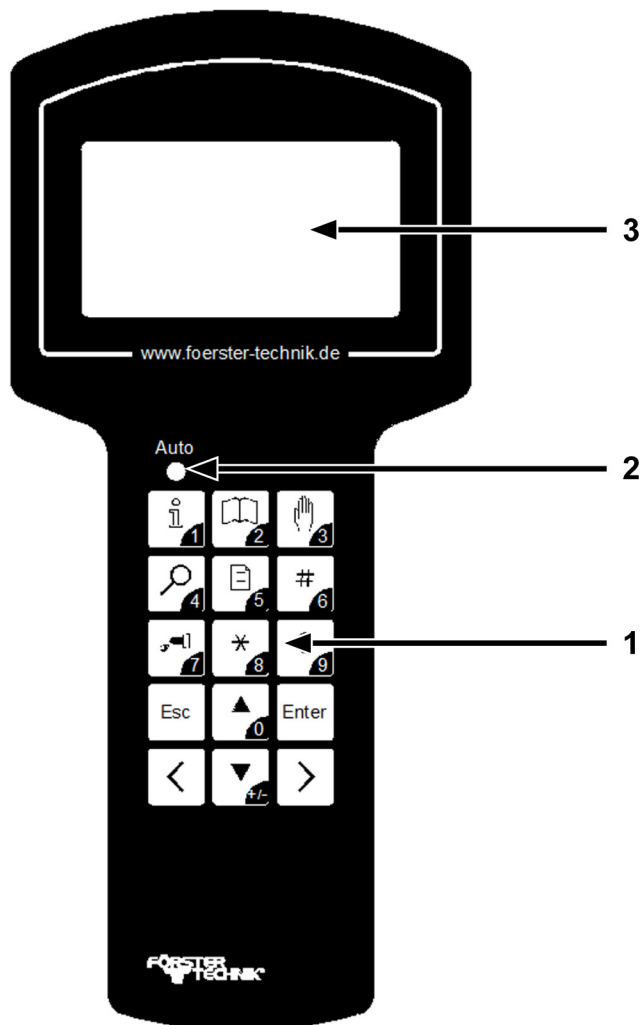

- 1 Keypad
- 2 Auto LED
- 3 Display

4.4.1 The keypad

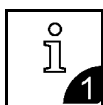

With this key you open the **Animal control** menu or enter the number 1.



With this key you open the **Main menu** or enter the number 2.



With this key you open the **Manual functions** menu or enter the number 3.



With this key you open the **Search functions** menu or enter the number 4.



With this key you open the **Animal list** or enter the number 5.



This key is a freely selectable **function key**. With this key, you can enter the number 6.



With this key you activate the **Feeding pump** or enter the number 7.



This key is assigned 2 functions:

- You press this key to select a calf in sub-menus in which an animal number is displayed. An asterisk (*) is displayed in front of the animal number of a selected calf. You deselect the calf by pressing this key again.
- In the overview menu in automatic mode, you use this key to toggle between the four-line (large font) and the eight-line (small font) display.

With this key, you can enter the number 8.

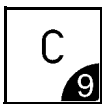

This key is assigned 2 functions depending on the menu you are currently using:

- You use this key to delete warnings and alarms.
- In the overview menu of automatic mode, you use this key to bring warnings to the foreground.

With this key, you can enter the number 9.

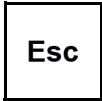

You use this key to go backward within the menu structure. You return to the starting menu by pressing this key multiple times.

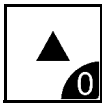

You use this key to move the cursor upward and choose items from a list, for example [yes] or [no]. With this key, you can enter the number 0.



With this key you move the cursor downward and select items from a list. You use this key to change the sign of a number, for example from +1 to -1. This is how you enter negative numbers.



You use this key to confirm your selection and open a menu or an input field. An [input field] is indicated by square brackets.



You use this key to scroll between pages on the screen or list items to the left and jump to the start of a list.

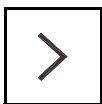



You use this key to scroll between pages on the screen to the right and jump to the end of a list.

4.4.2 Data backup

The automatic feeder performs an automatic data backup at night. You can also start the backup manually. The data of the automatic feeder can be stored on an SD card.

4.5 Menu structure

The automatic feeder is controlled using menus, sub-menus and lists. You control your automatic feeder by switching to lists via menus and sub-menus. In these lists, you can view and change values. The menu structure makes it easier to find a list quickly.

Experience shows that the **Animal control** is the list you will need most often . **Main menu**  and **Manual functions**  can be directly accessed with the press of button.

Experience shows that the **Animal list** is the list you will need most often. The animal list can be accessed directly via the key . You can change this default setting. You can also access the animal list via the **Animal control** menu.

You can also assign an additional  key according to your needs in Device data under Function keys.

If you do not see all the menus or sub-menus presented here, this is either because the automatic feeder is not equipped with the component in question, or the component was not activated during setup.

Note: If you know that your automatic feeder has a component that is not being displayed, contact your service technician so that he/she can adjust your setup. Never adjust the setup yourself.

NOTICE!

Changing the setup can cause the automatic feeder to malfunction.

If the automatic feeder malfunctions, your calves could suffer from malnutrition. Malnutrition can cause impaired growth and development, increased susceptibility to illness or even the death of your calves.

4.5.1 Symbols

Different symbols are displayed in front of and in several menus, sub-menus and lists.

4.5.1.1 Arrows



In automatic mode, arrow heads are shown in front of menus:

- ► A solid arrow head indicates that the menu contains sub-menus.
- ▷ An empty arrow head means that you can change settings here or start actions.

4.5.1.2 Angle brackets

< > Angle brackets around a menu or list mean that you can choose between menu options or list items. For example, you can select the appropriate calf from a list of animal numbers using the calf's animal number. If you see angle brackets at the top of the display, it means you can scroll left and right.

4.5.1.3 Square brackets

[] Values or terms are shown in square brackets. If you press  the value / list item begins to flash in the input field. You can now use the number keys to enter values or use   to select values from a list, such as [yes] or [no].

Note: If you enter a value in an input field and the value is too high or too low, this value will automatically be set to the highest (too high) or lowest (too low) possible value after you press .

4.5.1.4 Rod electrode free/covered

The following symbols appear at the top right of your display when animals are being fed in feed mode.



This symbol indicates that the mixer beaker is full. The tip of the rod electrode is in the liquid.



This symbol indicates that the mixer beaker is empty. The rod electrode is clear of the liquid.

4.5.1.5 Animal identification and feed consumption



The antenna symbol after a station number, such as TR1 for feeding box 1, indicates that a calf is identified at this station.

✓ A check mark after the antenna symbol means that calf identified at this station may consume feed here.



A lock symbol after the antenna symbol means that calf identified at this station may not consume feed here. For example, this could be because the concentration of feed in the mixer beaker does not match the feed settings for the identified calf.

- A hyphen after the station number indicates that no calf is identified at this station.

4.5.1.6 Plan tendency

The arrow to the right next to the animal number indicates the feeding phase the selected calf is now in.

↗ The feed quantity increases continuously, for example at the beginning of the feeding plan.

→ The feed quantity remains constant, for example in the middle of the feeding plan.

↘ The feed quantity is continuously reduced, for example at the end of the feeding plan.

f The calf is in the 40FIT period.

4.5.1.7 Marking

* Marked calves are indicated by an asterisk to the left of the animal number.

4.5.1.8 Alarms

! An exclamation mark to the left of the animal number indicates that a calf has triggered an alarm.

4.5.1.9 Winter feeding plan



This symbol at the top middle of the display shows you that the winter feeding plan is active.

4.5.1.10 CalfCloud



C This symbol is displayed in the first line of automatic mode if a connection to the CalfCloud exists.

4.5.1.11 Sleep mode



The Förster-Technik logo shows you that no key has been pressed on the hand terminal for an extended period of time. The hand terminal is in sleep mode.

4.5.1.12 Navigation

You use the hand terminal's keys to navigate through menus, sub-menus and lists.

Choose  :

- Move between the different sub-menus of a menu.
- Move between the items in a list, for example between **[yes]** and **[no]**.



Choose  :

- Scroll through a list, for example through the calibration menu. At the end of the list, the message "end of the list" will appear in the display.
- When you enter numbers, switch between whole numbers, for example from 1 to 2 to 3.
- Jump to the last menu item.

Choose :

- Confirm an entry.
- Confirm a prompt or message shown on the display.
- Confirm a selection.
- Open menus and sub-menus.
- Open input fields, which are indicated by square brackets.
- Switch from the number before the decimal place to the number after the decimal place in input fields.

You can use :

- Go back one menu, each time you press the key. You return to the starting menu by pressing this key multiple times.
- Exit the input field or return, without saving, to the number before the decimal place in an input field.
- Shift the screen display to the left or the right: Keep the  depressed, and in addition press the  or . For some Asiatic languages this procedure may be necessary in order to display the full text on the screen.

4.6 Menus

4.6.1 Animal control

You can choose  to open the **Animal control** menu. This menu contains all the sub-menus you require for daily calf monitoring. The numbers next to the sub-menus indicate the number of calves recorded in the sub-menu concerned.

- **Animal list.** You will see a table that shows the calves, sorted by different parameters, such as visits to the feeding box.
- **Entitlement.** A list of calves is displayed, sorted by feed entitlement.

- **Alarm.** You will see a list of the calves that have triggered an alarm.
- **Plan over date.** You will see a list of the calves that have a "plan over" date.
- **40FIT.** You will see a list of the calves which are currently in the 40FIT period.
- **marked.** You will see a list of calves that have been marked.
- **new.** Here you can view animals that were newly registered in the last 2 days.
- **duplicate.** Here you assign a new animal number to calves that have been assigned a duplicate animal number.
- **unknown.** Here you check whether and when the automatic feeder recorded unknown animal numbers. Here you can correctly register calves that have been recorded in this way.
- **all.** You will see a list of all calves.
- **Total consumption.** Several lists are displayed with the consumption amounts of all calves, individual calves and individual groups.
- **Press (optional).** Here you can print out the alarm list and the feed list.

4.6.2 Main menu



You can choose  to open the main menu. This menu contains all the sub-menus that you require for the daily operation of the automatic feeder.

- **Animal management** (see 7. "Transmitter and animal management" - 58)
- **Feeding** (see 8. "Feeding" - 66)
- **Calibrating** (see 10. "Calibration" - 97)
- **Device data** (only for service technicians)
- **Cleaning** (see 6. "Cleaning" - 37)
- **Diagnostics** (see 12. "Faults and warnings" - 105)

4.6.3 Manual functions

You can choose  to open manual functions. Here you can start certain functions of the automatic feeder manually. For example, you can manually empty the mixer or dispense extra portions (see 8.3.4 "Extra portion" - 71).

If you press , the automatic feeder switches from automatic to manual mode. The LED extinguishes and the automatic feeder is in offline mode.

You can actively switch the automatic feeder back to automatic mode. Press  until the message **Start automatic mode?** appears in the display. Confirm this message with . The automatic feeder will return to automatic mode. The Auto LED lights up green.

You can control the following functions manually:

- **Extra portion.** Here you can dispense extra portions with or without additives.
- **Mixer: empty?** The mixer is drained via the mixer drain valve.
- **Milk: suck in?** Here milk is sucked from the milk tank.
- **Milk: expel.** Here water is used to expel milk from the heat exchanger.
- **Milk: start?** Here you open the milk valve and start the milk pump.
- **Boiler water: start?** Here you add water from the boiler to the mixer.

-
- **Powder: start?** Here you start dispensing powder.
 - **Mixer: start?** Here you start the mixer.
 - **Feeding box** (optional). Here you open the feeding box valve(s). The valves remain open until you close them by choosing .
 - **HE: fill?** Here you automatically fill the heat exchanger with water.
 - **Hoses: open?** Here you can open several valves simultaneously in order to completely drain all the lines of the automatic feeder of water. The lines remain open until you close them by choosing .

5. Operation

5.1 Feeder operating modes

You can run your automatic feeder either in **rationed mode** or in **ad lib mode** (emergency mode).

5.1.1 Rationed mode

In **rationed mode**, the automatic feeder uses animal identification. You can custom-feed your calves.

When calves are registered in a group, they receive feed according to that group's feeding plan. You can also feed individual calves differently from the group feeding plan. For example, you can feed extra portions to a single calf.

If the mixer beaker is empty and a calf entitled to feed enters the feeding box and is identified, the automatic feeder prepares a feed portion that is specially adjusted for that calf.

- If the calf finishes this portion and is still entitled to feed, a second portion is prepared.
- If the calf is no longer entitled to feed, the feeding box valve is closed after the mixer is drained and closed after a drink-out time that you have defined or when the IFS pump has stopped. You define the drink-out time together with your service technician during commissioning.
- If during the first portion of a feed the calf stops feeding, this first portion is not recorded.
- If a calf stops feeding before finishing its portion, the feeder handles the remaining feed as follows:
 - The remaining feed is dispensed to each calf entitled to feed. The remaining feed is booked for the calf that actually finishes it.
 - Feed that remains in the mixer beaker is automatically pumped out after a period that you define in **Device data > Portion > Draining**.

Note: This function should not be disabled. Otherwise, the risk of infection would increase.

5.1.2 Ad lib mode (emergency mode)

In **ad lib mode**, the feeder does not use animal identification. Whenever the mixer beaker is empty, i.e., when the rod electrode is not covered by feed in the mixer beaker, the automatic feeder prepares a portion of feed. Since the automatic feeder is not using animal identification, custom feeding is not possible. You can only feed calves together if they are the same age and have the same feed entitlement.

WARNING!

Beware of the risk of burns on feeding box valves (optional).

During prolonged ad lib mode, any feeding box valves that are fitted become hot. You can burn your fingers or hand when touching these valves.

- ▶ For this reason, push the suction hose directly onto the mixer beaker spout and disconnect the connector from the feeding box valve.

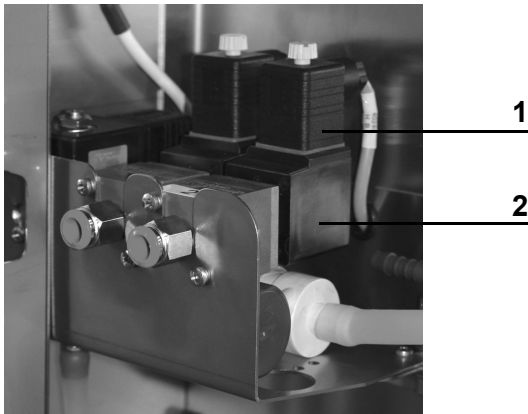

- 1 Device socket
- 2 Feeding box valve



NOTICE!

Cleaning agent that enters the feed can be hazardous to the health of calves.

- ▶ Therefore, always disable all time-controlled cleaning menus and calibrations during ad lib mode.

5.2 Cloud

This menu allows you to perform the relevant settings for the cloud.

1. Navigate via  > **Device data** to go to the **Cloud** sub-menu.
2. In **Finish?** you break off the connection to the cloud and therefore stop data transfer.
3. In **start?**, press . You then create the connection between the cloud and the automatic feeder.

You will see the message **You hereby accept the data protection provisions listed on www.calf-cloud.com!**. Press .

4. In **Status**, you can see the current status of the connection to the cloud. The possible statuses are **online**, **offline** or **reconnecting**.
5. In **Auth. token** you can see the authentication key for the automatic feeder.

Note: This token allows you to add the automatic feeder to the cloud data.

6. In **last error** you can view the following error displays:
 - 6.1. **none**. There are no errors present.
 - 6.2. **no eth. cable**. No Ethernet cable is plugged in.
 - 6.3. **no Internet**. There is no Internet connection available.
 - 6.4. **connect.error**. There is a connection error to the server.
7. **File Transfer** is only for the manufacturer.
8. In **Software Update** your service technician can perform an update to the automatic feeder.

5.3 Routine tasks

Daily running of the automatic feeder involves routine tasks such as cleaning, feeding, animal control and care and maintenance. This chapter explains how the automatic feeder facilitates these routine tasks for you. Checklists can be found in the appendix (see 14.5.2 "Maintenance intervals and activities" - 126) with the necessary cleaning and maintenance tasks.

Daily tasks:

- Clean the automatic feeder.
- Feed calves.
- Animal monitoring.
- Care and maintenance.

Weekly tasks:

- Care and maintenance.
- Clean the heat exchanger with a sponge.
- If the automatic feeder does not have mixer scales, recalibrate the water, milk, milk substitute and cleaning agent.
- If the automatic feeder does not have mixer scales, recalibrate the cleaning agent.
- Care and maintenance.
- Replace wearing parts.

Annual tasks:

- Thoroughly clean the automatic feeder.
- Replace wearing parts.
- Care and maintenance.

6. Cleaning

You must clean all parts of the automatic feeder that come into contact with liquid or powder animal feed.

Note: If you have installed additional devices such as an **additive dispenser**, the **IFS feeding station**, the **ActivityBox** or the **CalfRail**, you must also follow the cleaning instructions in the operating manual for these devices.

The type of feed you are using also plays a role here. For example, raw milk contains more germs than pasteurized milk. Therefore, if you are feeding raw milk, you must clean the feeder more often than if you are using pasteurized milk.

Your automatic feeder is equipped as standard with a cleaning agent pump for alkaline cleaning agents (flushing agent 1). Optionally a cleaning agent pump for acid cleaning agents (flushing agent 2) is available.

Cleaning methods

You can use a range of cleaning methods, which you can also combine:

- You can clean the automatic feeder with a cleaning agent or without.
- You can clean some parts, such as the mixer, using programs that run automatically.
- You can clean some parts, such as the powder container, manually.
- You can clean some parts, such as the heat exchanger, using programs that are started manually.

You clean the automatic feeder as follows:

- Clean the mixer.
- Clean the heat exchanger.
- Cleaning cycle.
- Clean the suction hose.
- Rinse the hose.
- Drain the hoses (drainage mode).
- Clean the powder container and dosing unit.
- Dosing pump with cleaning agent lance.

6.1 Cleaning with cleaning agents

For daily cleaning a commercially-available **alkaline cleaning agent** (flushing agent 1) can be used. Additionally, when necessary but in any case no less than every 5th cleaning procedure, a cleaning procedure should be performed with an **acid cleaning agent** (flushing agent 2).

Remember:

- The cleaning agents must be able to be used within a temperature range of 40 to 58 °C.
- You must follow all safety instructions in the safety data sheet for the cleaning agent you are using.
- You must always wear the protective gear, such as protective goggles and gloves, specified in the safety data sheet for the cleaning agent you are using.

- Undiluted cleaning agent may not be drained into the ground water or sewage system. Observe the recommendations in the safety data sheet for your cleaning agent and contact your water utility company and your sewage disposal company to find out which regulations apply to you.
- Be sure to comply with the manufacturer's instructions and national regulations for the handling, use, storage and place of installation of the additive being used.
- Observe the cleaning intervals recommended by the manufacturer of the cleaning agent as well as those recommended in this operating manual (see 14.5.2 "Maintenance intervals and activities" - 126).
- Never mix alkaline and acid cleaning agents.
- Make sure that the vapors of alkaline and acid cleaning agents can never mix.
- Observe the manufacturer's guidelines regarding the amount, temperature and concentration of cleaning agent used.
- Do all of the cleaning recommended in this operating manual.
- Twice a week perform a cleaning procedure with an acid cleaning agent.

NOTICE!

Never use cleaning agents containing chlorine, as they can attack the materials of the automatic feeder and impair its function.

(see 14.4 "Materials list" - 125) If this happens, your calves may not receive enough feed. This can lead to malnutrition, which can cause impaired growth and development, increased susceptibility to illness or even the death of your calves.

6.1.1 Preparing for cleaning

6.1.1.1 Cleaning programs that start automatically



WARNING!

Chemical burns due to the cleaning agents used.

The cleaning agent can cause chemical burns to your eyes or hands.

- ▶ Always wear safety glasses and protective gloves when using cleaning agents. Follow all the safety instructions listed in the safety data sheet for the cleaning agent and wear the specified safety equipment.
-

Make sure that sufficient cleaning agent is available.

6.1.1.2 Cleaning programs that are started manually

WARNING!

Chemical burns due to the cleaning agents used.

The cleaning agent can cause chemical burns to your eyes or hands.

- ▶ Always wear safety glasses and protective gloves when using cleaning agents. Follow all the safety instructions listed in the safety data sheet for the cleaning agent and wear the specified safety equipment.

Prepare for cleaning as follows:

1. Measure the necessary amount of cleaning agent. Consult the data sheet for the cleaning agent to determine the quantity recommended by the cleaning agent manufacturer.
2. Prepare the cleaning agent next to the automatic feeder.

6.1.2 Cleaning with a cleaning agent

6.1.2.1 Basic settings

In the **Settings** menu, you define values for the cleaning temperature, cleaning agent amount and teat cleaning.



You define basic settings as follows:

1. Navigate via  > **Cleaning** to the **Settings** sub-menu.
2. In the **Temperature** menu, you enter the desired temperature. You can enter values between 10°C and 58°C. The default setting is 45°C.

Note: Consult the data sheet for the cleaning agent to determine the temperature recommended by its manufacturer and enter this value.

3. In the **Flushing agent** menu, enter the required amount of cleaning agent. You can enter values between 0 ml/l and 25 ml/l. The default setting is 0 ml/l.

Note: Consult the data sheet for the cleaning agent to determine the amount recommended by its manufacturer and enter this value.

4. In the **Clean teat** menu, choose  , **[yes]** if you wish to rinse the inside of the teat with clean water. The water is pumped through the suction hoses and drained via the teat. The default setting is **[no]**.

Note: Teat cleaning is important step to prevent infections and should therefore should always be selected.

Note: The quantity of rinsing water is taken from the set quantity for cleaning the circuit.

6.1.2.2 Cleaning the mixer

You can clean the mixer automatically (at scheduled intervals) or manually, with or without cleaning agent. A cleaning cycle consists of:

- **Pre-cleaning.**
- **Main cleaning** with the addition of cleaning agent. Cleaning will start automatically.
- **Rinsing.**

Mixer is cleaned automatically at scheduled intervals

Note: You do not have to set automatic mixer cleaning if you have set daily cleaning for the heat exchanger. The mixer is always cleaned when the heat exchanger is cleaned.

Cleaning agent is added automatically. You must check each day to ensure that the cleaning agent containers are full and that the cleaning agents are being dispensed into the mixer.



WARNING!

Chemical burns due to the cleaning agents used.

The cleaning agent can cause chemical burns to your eyes or hands.

- ▶ Always wear safety glasses and protective gloves when using cleaning agents. Follow all the safety instructions listed in the safety data sheet for the cleaning agent and wear the specified safety equipment.

Note: The cleaning water is pumped out via the mixer drain valve.

Two automatic mixer cleaning cycles are preset, at 07:00 hours and at 22:00 hours.

You select automatic mixer cleaning as follows:

1. Navigate via  > **Cleaning** > **Mixer** to go to the **Clean mixer** sub-menu.
2. In the **Cleaning cycles/day** menu, you enter the required number of cleaning cycles. You can set a maximum of 4 cleaning cycles.

Note: You should define at least 1 cleaning cycle per day in order to prevent unhygienic conditions.

3. For **Cleaning time 1**, enter the desired time of day.
4. Repeat step 4 for additional **cleaning times**.
5. Activate or deactivate the **drainage mode** via the menu option with the same name. Drainage mode is activated by default.

If drainage mode is activated, then each time that the mixer is drained to evacuate a residual portion to all of the available stations, all of the feeding box valves will be opened for one minute to allow the liquid remaining in the hoses to be drained. The suction hoses are drained after each cleaning cycle.



Note: Start the cleaning at a time when there is minimal entitlement to feed so that your calves do not have to wait too long for feed.

Note: If there is still feed in the mixer beaker at the set cleaning time, automatic cleaning will be postponed by a maximum of one hour. After that, any remaining feed will be pumped out via the mixer drain valve and the cleaning cycle will be started.

Manually starting mixer cleaning

To prevent unhygienic conditions when the automatic cleaning of the mixer is disabled, perform an automatic cleaning cycle at least 2 times a day without adding cleaning agent, and every other day with manually added cleaning agent.

You start manual mixer cleaning as follows:

1. Navigate via  > **Cleaning** > **Mixer** to go to the **Clean mixer** sub-menu.
2. In **start?**, press .
 - 2.1. Enter the required amount of cleaning agent and confirm by choosing .

Note: Start the cleaning at a time when there is minimal feed entitlement so that your calves do not have to wait too long for their feed.

Note: To perform cleaning with acid cleaning agent you can set the value to 0 ml/ltr and add the acid cleaning agent manually to the main cleaning cycle. When filling, make sure there is sufficient water in the mixer beaker.

Cleaning the mixer beaker manually

If it is visibly dirty, if you have disabled automatic cleaning or if you perform automatic cleaning less than twice a day, you must clean the mixer beaker manually.





WARNING!

There is a risk of injury due to automatic start-up.

The automatic feeder automatically prepares a feed portion when it detects a calf entitled to feed. The stirring blades in the mixer beaker start automatically and can crush or cut off your hand or fingers.

- ▶ Always switch off the automatic feeder and disconnect the power plug before manually cleaning the mixer.







You clean the mixer manually as follows:

1. Press  and confirm **Bo. water start?** by choosing .
- The mixer beaker is filled with water.
2. Confirm **Mixer: empty?** by choosing .
3. Confirm **Bo. water start?** by choosing . Fill 2/3 of the mixer beaker with water.
4. Pour the prepared cleaning agent into the mixer.

 **WARNING!**
Beware of chemical burns from the cleaning agents used.

The cleaning agent can cause chemical burns to your eyes or hands. Always wear goggles and protective gloves when using cleaning agents.

- ▶ Follow all the safety instructions listed in the safety data sheet for the cleaning agent and wear the specified safety equipment.
-

5. Switch off the automatic feeder and disconnect the mains plug.
6. Clean the mixer beaker with a soft brush or a soft sponge.
7. Insert the mains plug again and switch the automatic feeder on again.
8. Press  and confirm **Mixer: empty?** with .
9. Confirm **Bo. water start?** by choosing . Fill 2/3 of the mixer beaker with water.
10. Confirm **Mixer: start?** by choosing , to rinse the mixer with clean water.
11. Confirm **Mixer: empty?** by choosing .
12. Press  until the message **Start automatic mode?** appears in your display.
13. Confirm **Start automatic mode?** by choosing .

The automatic feeder is now operating in automatic mode again.

6.1.2.3 Cleaning the heat exchanger

Liquid feed is constantly flowing through the heat exchanger, resulting in the formation of milk deposits. These milk deposits are an ideal breeding ground for germs. Therefore, clean the heat exchanger thoroughly with water and cleaning agent every day (see 6.1.2.4 "Flushing circuit" - 43).

You must clean the heat exchanger **once a week** with the sponge. By doing this, you can determine whether your cleaning measures are effective.

 **WARNING!**
Chemical burns due to the cleaning agents used.



The cleaning agent can cause chemical burns to your eyes or hands.

- ▶ Always wear safety glasses and protective gloves when using cleaning agents. Follow all the safety instructions listed in the safety data sheet for the cleaning agent and wear the specified safety equipment.
-

Cleaning the heat exchanger automatically at scheduled intervals

The default setting is to clean the heat exchanger automatically twice a day (at 07:00 hours and at 22:00 hours).

You set automatic heat exchanger cleaning as follows:

1. Navigate via  > **Cleaning** > **Heat exchanger** to go to the **Clean heat exchanger** sub-menu.
2. You can start automatic cleaning in the **start?** menu.
 - 2.1. Enter the required amount of cleaning agent and confirm by choosing .
3. In the **Cleaning cycles/day** menu, you enter the required number of cleaning cycles. You can set a maximum of 4 cleaning cycles.

Note: You should define at least 1 cleaning cycle per day in order to prevent unhygienic conditions.

4. In the **Cleaning 1 to 4** menu, you enter the required time of day.

Note: Start the cleaning at a time when there is minimal entitlement to feed so that your calves do not have to wait too long for feed.

Note: If you dispense milk from a tank, you must clean the heat exchanger once more, as soon as the tank is empty.

You set an additional automatic heat exchanger cleaning cycle as follows:



1. In the **Milk empty** menu, choose   [yes].

Each time the milk in the tank is used up, the additional automatic heat exchanger cleaning cycle will be started.

Cleaning the heat exchanger manually

If you have disabled automatic heat exchanger cleaning, you must manually clean the heat exchanger at least once per day.

You clean the heat exchanger manually as follows:

1. Navigate via  > **Cleaning** > **Heat exchanger** to go to the **Clean heat exchanger** sub-menu.
2. Confirm **Start?** by choosing .
3. In the **Flushing agent** menu, you enter the required amount.

The manual cleaning of the heat exchanger will start.

Note: To perform cleaning with acid cleaning agent you can set the value to 0 ml/ltr and add the acid cleaning agent manually to the main cleaning cycle. When filling, make sure there is sufficient water in the mixer beaker.

6.1.2.4 Flushing circuit

Note: If you have connected an IFS feeding station and/or an Activity Box to your automatic feeder, please comply with the “cleaning” chapters in the respective operating manuals.

In a cleaning cycle, you clean the suction hoses and the heat exchanger at the same time.

You require the flushing adapter and the hose nozzles shown below. These items are supplied with the automatic feeder.



- 1 Hose nozzle
- 2 Flushing adapter
- 3 Rubber sealing cap
- 4 Suction hose (station 1)
- 5 Suction hose (station 2)
- 6 Coupling piece for the milk connection

Run the cleaning cycle at least **once a day** if automatic heat exchanger cleaning is not enabled.
Run the cleaning cycle at least **once a week** if automatic heat exchanger cleaning is enabled.

Perform a cleaning cycle as follows:

1. Navigate via  > **Cleaning** to the **Cleaning cycle** sub-menu.
2. In the **Water/box** menu, you enter the desired amount of water. You can enter values from 0.5 ltr to 1.5 ltr. The preset default value is 1 ltr.

Note: The longer the hoses, the higher the value you must select.

3. Confirm **Start?** by choosing .
- The message **Exit automatic mode?** appears in the display.
4. Confirm **Exit automatic mode?** by choosing .
5. In the Cleaning menu, you enter the desired amount of cleaning agent. Use the amount recommended in the data sheet for your cleaning agent.

In the Cleaning (options) menu, you enter the desired amount of cleaning agent. Use the amount recommended in the data sheet for your cleaning agent.

The automatic feeder will start the **Pre-cleaning**. After the mixer has been automatically pumped out, clear instructions are shown in the display. Follow these instructions:

- 5.1. On all feeding boxes, disconnect the suction hoses from the spouts that lead to the teats.
 - 5.2. Push these suction hoses onto the plastic hose nozzle of the cleaning adapter.
 - 5.3. Position the cleaning adapter with the connected hoses so that the rinsing water can drain directly into the gully.
6. To confirm that the instructions have been followed, choose .

The automatic feeder continues the **pre-cleaning**. When pre-cleaning is completed, further instructions will appear in the display. Follow these instructions:

- 6.1. Disconnect the milk hose from the milk connection of the automatic feeder.
- 6.2. Connect the flushing adapter to the milk connection.

7. To confirm that the instructions have been followed, choose .

The automatic feeder will start the **main cleaning cycle**. The remaining time appears in the display.

When the main cleaning cycle is completed, further instructions appear in the display. Follow these instructions:

- 7.1. Disconnect the flushing adapter and the connected hoses from the milk connection.
- 7.2. Position the cleaning adapter with the connected hoses so that the rinsing water can drain directly into the gully.

8. To confirm that the instructions have been followed, choose .



The automatic feeder will start the **rinsing** cycle.

- 8.1. Reconnect the milk hose to the automatic feeder.
- 8.2. Once the cleaning is finished, push the suction hoses back onto the hose nozzles of the respective teats.

9. Press  until the message **Start automatic mode?** appears in the display.

10. Confirm **Start automatic mode?** by choosing .

The automatic feeder is now operating in automatic mode again.

11. Press  and confirm **Milk: suck in?** by , to fill the heat exchanger with water

6.1.3 Cleaning with two cleaning agents

6.1.3.1 Basic settings

In the **Settings** menu, you define values for the cleaning temperature, cleaning agent amount and teat cleaning.

You define basic settings as follows:

1. Navigate via  > **Cleaning** to the **Settings** sub-menu.
2. In the **Temp. SP 1** menu, you enter the desired temperature of the alkaline cleaning agent. You can enter values between 10°C and 58°C. The default setting is 45°C.

Note: Consult the data sheet for the cleaning agent to determine the temperature recommended by its manufacturer and enter this value.

3. In the **Temp. SP 2** menu, you enter the desired temperature of the acid cleaning agent. You can enter values between 10°C and 58°C. The default setting is 45°C.



Note: Consult the data sheet for the cleaning agent to determine the temperature recommended by its manufacturer and enter this value.

4. In the **Flushing agent 1** menu, you enter the desired cleaning agent quantity for the alkaline cleaning agent. You can enter values between 0 ml/l and 25 ml/l. The default setting is 0 ml/l.

Note: Consult the data sheet for the cleaning agent to determine the amount recommended by its manufacturer and enter this value.

5. In the **Flushing agent 2** menu, enter the desired cleaning agent quantity for the acid cleaning agent. You can enter values between 0 ml/l and 25 ml/l. The default setting is 0 ml/l.

Note: Consult the data sheet for the cleaning agent to determine the amount recommended by its manufacturer and enter this value.

6. In the **Clean teat** menu, choose  , **[yes]** if you wish to rinse the inside of the teat with clean water. The water is pumped through the suction hoses and drained via the teat. The default setting is **[no]**.

Note: Teat cleaning is important step to prevent infections and should therefore should always be selected.

Note: The quantity of rinsing water is taken from the set quantity for cleaning the circuit.

6.1.3.2 Cleaning the mixer

You can clean the mixer automatically (at scheduled intervals) or manually, with or without cleaning agent. A cleaning cycle consists of:

- **Pre-cleaning.**
- **Main cleaning** with the addition of cleaning agent. Cleaning will start automatically.
- **Rinsing.**

Mixer is cleaned automatically at scheduled intervals

Note: You do not have to set automatic mixer cleaning if you have set daily cleaning for the heat exchanger. The mixer is always cleaned when the heat exchanger is cleaned.

Cleaning agent is added automatically. You must check each day to ensure that the cleaning agent container is full and that the cleaning agent is being dispensed into the mixer.



WARNING!

Chemical burns due to the cleaning agents used.

The cleaning agent can cause chemical burns to your eyes or hands.

- ▶ Always wear safety glasses and protective gloves when using cleaning agents. Follow all the safety instructions listed in the safety data sheet for the cleaning agent and wear the specified safety equipment.

Note: The cleaning water is pumped out via the mixer drain valve.

The default setting is 2 automatic mixer cleaning cycles.

You select automatic mixer cleaning as follows:

1. Navigate via  > **Cleaning** to the **Mixer** sub-menu.

2. In **SP 2 switchover n.** enter the number of cleaning cycles after which the automatic feeder should switch to the second cleaning agent. The default setting is 3 cleaning cycles.

The lines below show the current count **SP 2 in x cleaning cycles**.

3. In the **Cleaning cycles/day** menu, you enter the required number of cleaning cycles. You can set a maximum of 4 cleaning cycles.

Note: You should define at least 1 cleaning cycle per day in order to prevent unhygienic conditions.

4. For **Cleaning time 1**, enter the desired time of day.

5. Repeat step 4 for additional **cleaning times**.

6. Activate or deactivate the **drainage mode** via the menu option with the same name. Drainage mode is activated by default.

If drainage mode is activated, then each time that the mixer is drained to evacuate a residual portion to all of the available stations, all of the feeding box valves will be opened for one minute to allow the liquid remaining in the hoses to be drained. The suction hoses are drained after each cleaning cycle.

Note: Start the cleaning at a time when there is minimal entitlement to feed so that your calves do not have to wait too long for feed.

Note: If there is still feed in the mixer beaker at the set cleaning time, automatic cleaning will be postponed by a maximum of one hour. After that, any remaining feed will be pumped out via the mixer drain valve and the cleaning cycle will be started.

Manually starting mixer cleaning

To prevent unhygienic conditions when the automatic cleaning of the mixer is disabled, perform an automatic cleaning cycle at least 2 times a day without adding cleaning agent, and every other day with manually added cleaning agent.

You start manual mixer cleaning as follows:

1. Navigate via  > **Cleaning** to the **Mixer** sub-menu.
2. In the **start flushing agent 1?** menu, press , to perform an alkaline cleaning cycle, or in the **start flushing agent 2?** menu, press , to perform an acid cleaning cycle.
 - 2.1. If necessary confirm **Exit automatic mode?** by choosing .
 - 2.2. Enter the required amount of cleaning agent and confirm by choosing .

Note: Start the cleaning at a time when there is minimal feed entitlement so that your calves do not have to wait too long for their feed.

6.1.3.3 Cleaning the heat exchanger

Liquid feed is constantly flowing through the heat exchanger, resulting in the formation of milk deposits. These milk deposits are an ideal breeding ground for germs. Therefore, clean the heat exchanger thoroughly with water and cleaning agent every day (see 6.1.3.4 "Flushing circuit" - 49).

You must clean the heat exchanger **once a week** with the sponge. By doing this, you can determine whether your cleaning measures are effective.



WARNING!

Chemical burns due to the cleaning agents used.

The cleaning agent can cause chemical burns to your eyes or hands.

- ▶ Always wear safety glasses and protective gloves when using cleaning agents. Follow all the safety instructions listed in the safety data sheet for the cleaning agent and wear the specified safety equipment.

Cleaning the heat exchanger automatically at scheduled intervals

The default setting is to clean the heat exchanger automatically twice a day.

You set automatic heat exchanger cleaning as follows:

1. Navigate via  > **Cleaning** to the **Heat exchanger** sub-menu.
2. In **SP 2 switchover n.** enter the number of cleaning cycles after which the automatic feeder should switch to the second cleaning agent. The default setting is 3 cleaning cycles.

The lines below show the current count **SP 2 in x cleaning cycles**.

3. In the **Cleaning cycles/day** menu, you enter the required number of cleaning cycles. You can set a maximum of 4 cleaning cycles.

Note: You should define at least 1 cleaning cycle per day in order to prevent unhygienic conditions.

4. In the **Cleaning 1 to 4** menu, you enter the required time of day.

Note: Start the cleaning at a time when there is minimal entitlement to feed so that your calves do not have to wait too long for feed.

Note: If you dispense milk from a tank, you must clean the heat exchanger once more, as soon as the tank is empty.

You set an additional automatic heat exchanger cleaning cycle as follows:

1. In the **Milk empty** menu, choose   [yes].

Each time the milk in the tank is used up, the additional automatic heat exchanger cleaning cycle will be started.

Cleaning the heat exchanger manually

If you have disabled automatic heat exchanger cleaning, you must manually clean the heat exchanger at least once per day.

You clean the heat exchanger manually as follows:

1. Navigate via  > **Cleaning** to the **Heat exchanger** sub-menu.

- In the **start flushing agent 1?** menu, press , to perform an alkaline cleaning cycle, or in the **start flushing agent 2?** menu, press , to perform an acid cleaning cycle.
- In the **Flushing agent** menu, you enter the required amount.

The manual cleaning of the heat exchanger will start.

6.1.3.4 Flushing circuit

Note: If you have connected an IFS feeding station and/or an Activity Box to your automatic feeder, please comply with the “cleaning” chapters in the respective operating manuals.

In a cleaning cycle, you clean the suction hoses and the heat exchanger at the same time.

You require the flushing adapter and the hose nozzles shown below. These items are supplied with the automatic feeder.

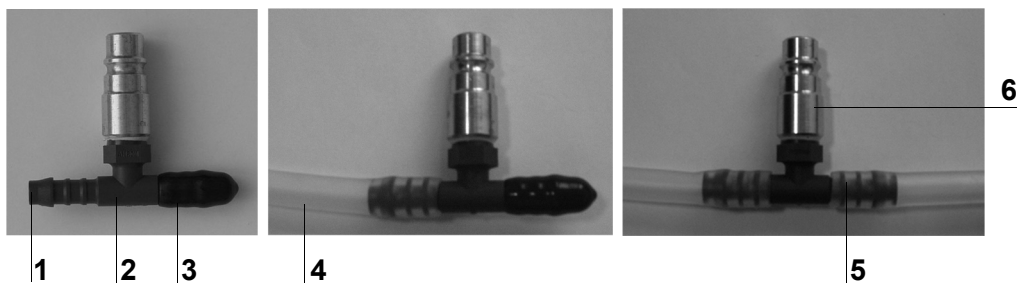

- Hose nozzle
- Flushing adapter
- Rubber sealing cap
- Suction hose (station 1)
- Suction hose (station 2)
- Coupling piece for the milk connection

Run the cleaning cycle at least **once a day** if automatic heat exchanger cleaning is not enabled.

Run the cleaning cycle at least **once a week** if automatic heat exchanger cleaning is enabled.

Perform a cleaning cycle as follows:

- Navigate via > **Cleaning** to the **Cleaning cycle** sub-menu.
- In the **Water/box** menu, you enter the desired amount of water. You can enter values from 0.5 ltr to 1.5 ltr. The preset default value is 1 ltr.

Note: The longer the hoses, the higher the value you must select.

- In the **start flushing agent 1?** menu, press , to perform an alkaline cleaning cycle, or in the **start flushing agent 2?** menu, press , to perform an acid cleaning cycle.

The message **Exit automatic mode?** appears in the display.

- Confirm **Exit automatic mode?** by choosing .
- In the Cleaning menu, you enter the desired amount of cleaning agent. Use the amount recommended in the data sheet for your cleaning agent.

The automatic feeder will start the **Pre-cleaning**. After the mixer has been automatically pumped out, clear instructions are shown in the display. Follow these instructions:

- 5.1. On all feeding boxes, disconnect the suction hoses from the spouts that lead to the teats.
- 5.2. Push these suction hoses onto the plastic hose nozzle of the cleaning adapter.
- 5.3. Position the cleaning adapter with the connected hoses so that the rinsing water can drain directly into the gully.

6. To confirm that the instructions have been followed, choose .

The automatic feeder continues the **pre-cleaning**. When pre-cleaning is completed, further instructions will appear in the display. Follow these instructions:

- 6.1. Disconnect the milk hose from the milk connection of the automatic feeder.
- 6.2. Connect the flushing adapter to the milk connection.

7. To confirm that the instructions have been followed, choose .

The automatic feeder will start the **main cleaning cycle**. The remaining time appears in the display. When the main cleaning cycle is completed, further instructions appear in the display. Follow these instructions:

- 7.1. Disconnect the flushing adapter and the connected hoses from the milk connection.
- 7.2. Position the cleaning adapter with the connected hoses so that the rinsing water can drain directly into the gully.

8. To confirm that the instructions have been followed, choose .

The automatic feeder will start the **rinsing** cycle.

- 8.1. Reconnect the milk hose to the automatic feeder.
- 8.2. Once the cleaning is finished, push the suction hoses back onto the hose nozzles of the respective teats.

9. Press until the message **Start automatic mode?** appears in the display.

10. Confirm **Start automatic mode?** by choosing .

The automatic feeder is now operating in automatic mode again.

11. Press and confirm **Milk: suck in?** by , to fill the heat exchanger with water

6.1.4 Clean the cleaning agent pump and the cleaning agent lance.







If switching over cleaning agent or interrupting the use of the cleaning agent, the cleaning agent pump and the cleaning agent lance must be cleaned.



 **WARNING!****Chemical burns due to the cleaning agents used.**

The cleaning agent can cause chemical burns to your eyes or hands.

- ▶ Always wear safety glasses and protective gloves when using cleaning agents. Follow all the safety instructions listed in the safety data sheet for the cleaning agent and wear the specified safety equipment.







6.1.4.1 Switching over cleaning agent

1. Exit automatic mode by pressing  and confirming the message **Exit automatic mode?** by choosing .
2. Disconnect the cleaning agent lance from the cleaning agent container and empty the cleaning agent container.
3. Wash out the cleaning agent container with clean water.
4. Fill a bucket with clean water and place the cleaning agent lance in it.
5. Navigate via  > **Diagnostics > Motors** to the **Flushing agent 1** sub-menu.
6. Confirm **Flushing agent: start?** by choosing  and keep the key depressed until approx. 1 ltr clean water has been dispensed. The cleaning agent pump is activated, thereby cleaning the line system.
7. Tip the mixer out and capture the liquid separately. Dispose of this as recommended by the cleaning agent manufacturer.
8. In the cover of the new cleaning agent container, drill a hole for the cleaning agent lance.
9. Attach the cleaning agent lance to the cover of the cleaning agent container.
Note: Small breather holes in the cover prevent the creation of a partial vacuum which would distort the cleaning agent container. In this respect comply with the manufacturer's specifications and the national regulations.
10. Position the cleaning agent container in the place provided for it.
11. Navigate via  > **Diagnostics > Motors** to the **Flushing agent 1** sub-menu.
12. Confirm **Flushing agent: start?** by choosing  and keep the key depressed until the line system is filled with the new cleaning agent.
13. Perform mixer cleaning without cleaning agent (see "Manually starting mixer cleaning" - 41).
14. Calibrate the cleaning agent (see 10. "Calibration" - 97).
15. If a second cleaning agent pump (**Flushing agent pump 2**) is connected to the automatic feeder, use the same method to clean this also.

16. Start automatic mode. Press  until the message **Start automatic mode?** appears in the display and confirm it by choosing .

6.1.4.2 Interrupting the use of the cleaning agent

Note: If you interrupt the use of the cleaning agent you must clean the system manually.

1. Exit automatic mode by pressing  and confirming the message **Exit automatic mode?** by choosing .
2. Disconnect the cleaning agent lance from the cleaning agent container and empty the cleaning agent container.
3. Wash out the cleaning agent container with clean water.
4. Fill a bucket with clean water and place the cleaning agent lance in it.
5. Navigate via  > **Diagnostics** > **Motors** to the **Flushing agent 1** sub-menu.
6. Confirm **Flushing agent: start?** by choosing  and keep the key depressed until approx. 1 ltr clean water has been dispensed. The cleaning agent pump is activated, thereby cleaning the line system.
7. Tip the mixer out and capture the liquid separately. Dispose of this as recommended by the cleaning agent manufacturer.
8. Perform mixer cleaning without cleaning agent (see "Manually starting mixer cleaning" - 41).
9. If a second cleaning agent pump (**Flushing agent pump 2**) is connected to the automatic feeder, use the same method to clean this also.
10. Start automatic mode. Press  until the message **Start automatic mode?** appears in the display and confirm it by choosing .

6.2 Cleaning without cleaning agents

6.2.1 Preparing for cleaning

6.2.1.1 Manual cleaning

- Powder discharge opening.
The scraper for cleaning is attached to the powder discharge opening.
- Powder container and dosing tongue.

Prepare for cleaning as follows:

1. Switch off the automatic feeder and disconnect the mains plug.
2. Have a damp cloth ready to clean the outside of the automatic feeder.

NOTICE!

Damage to the housing of the automatic feeder causes corrosion and impairs its function.

- ▶ Never use a high-pressure spray to clean the automatic feeder.

6.2.2 Cleaning the heat exchanger manually with a sponge



If you have disabled automatic heat exchanger cleaning, you must manually clean the stainless steel coil of the heat exchanger using the sponge ball **once a day**. The sponge ball serves as a mechanical cleaning tool that removes deposits and residual milk.

If you have enabled automatic heat exchanger cleaning, you must clean the heat exchanger **once a week** with the sponge. By doing this, you can determine whether your cleaning measures are effective.

If visible milk deposits are flushed into the mixer beaker during the sponge cleaning process, your cleaning measures are not sufficient. Do the following:

- Make sure that sufficient cleaning agent is available.
- Check whether the concentration of the cleaning agent corresponds to the manufacturer's recommendations.
- Check that the cleaning agent pump is working.
- Clean more frequently.

You clean the heat exchanger with a sponge as follows:

1. Have the red sponge ball which comes with your automatic feeder ready.
2. Navigate via  > **Cleaning** > **Sponge** to go to the **Cleaning with a sponge** sub-menu.
3. Confirm **Start?** by choosing .





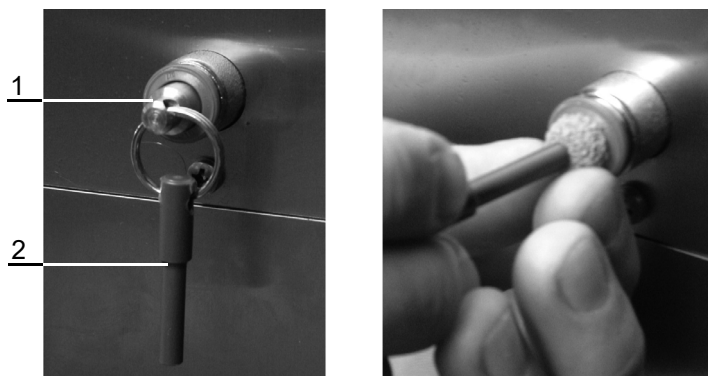

The message **Sponge inserted?** appears in the display.

4. On the automatic feeder, open the metal plug for the sponge cleaning procedure. (See pictures below)



- 1 Metal plug
- 2 Plunger

5. Push the red sponge ball into the opening using the plunger.



6. Close the metal plug again.
7. Confirm the display message **Sponge inserted?** by choosing .
Water pushes the sponge through the stainless steel coil of the heat exchanger, removing tough deposits.
8. When the message **Sponge in the mixer?** appears in the display, you can choose , to repeat the cleaning or choose , to end the cleaning.
Note: Repeat the cleaning until the sponge has returned to the mixer.
9. If the message **Sponge removed?** appears in the display, remove the sponge ball from the mixer beaker and confirm the display message by choosing .
The cleaning water is pumped out automatically.
10. Clean the sponge ball and store it in a dry place.
11. Press  and confirm **Milk: suck in?** by , to fill the heat exchanger with water

Note: If you can see dirt or deposits in the cleaning water, you must repeat the cleaning procedure immediately. Visible deposits in the rinsing water indicate that you are not cleaning the heat exchanger frequently enough. Therefore, you must clean the heat exchanger more frequently than before.

6.2.3 Drain the hoses

You can drain the hoses manually.

You can drain the hoses as follows:

1. Navigate via  > **Cleaning** menu and in **Start drainage mode** press .
- The hoses are drained for a period of one minute.

6.2.4 Cleaning the powder discharge opening

Check the powder discharge opening for milk powder deposits each day. Remove milk powder deposits immediately. By doing this, you prevent the powder discharge opening from clogging and dispensing insufficient milk powder.

NOTICE!

Insufficient milk powder in the feed causes undernourishment or malnutrition in your calves.

This can cause impaired growth and development, increased susceptibility to illness or even the death of your calves.

- ▶ Check the powder discharge opening every day.
-

 **WARNING!****There is a risk of injury due to automatic start-up.**

The powder dosing can start up automatically at any time, crushing or cutting off your fingers.

- ▶ Switch the automatic feeder off using the Control switch , disconnect the power plug and only use the supplied scraper to clean the powder discharge opening.

To clean the powder discharge opening, proceed as follows:

1. Switch the automatic feeder off using the Control switch and disconnect the mains plug.
2. Clean the powder outlet using the supplied scraper. Catch the loosened deposits and milk powder and dispose of them.
3. Reconnect the power plug.
4. Switch the automatic feeder on again using the Control switch .
5. Calibrate the milk powder (MP) (see 10. "Calibration" - 97).
6. Start automatic mode. Press until the message **Start automatic mode?** appears in the display and confirm it by choosing .

6.2.5 Thorough cleaning of the powder container with the dosing unit

During thorough cleaning of the powder container, milk powder deposits inside the powder container and dosing unit are removed. Thorough cleaning is required:

- If you shut down the automatic feeder.
- If you recommission the automatic feeder.
- If the feed that was added is contaminated with germs.

 **DANGER!****Fatal electric shock.**

The electrical components of the automatic feeder are live.



- ▶ Switch the automatic feeder off using the Control switch and disconnect the power plug before manually cleaning the powder container.

 **WARNING!****There is a risk of injury due to automatic start-up.**

The powder mixing unit can start up automatically at any time, crushing or cutting off your fingers.

- ▶ Do not reach into the hazardous area of the powder mixing unit. Switch the automatic feeder off using the Control switch before reaching into the power container.

To clean the powder container, proceed as follows:

1. Switch the automatic feeder off using the Control switch and disconnect the mains plug.
2. Remove the screws that hold the safety grid and remove it.
3. Clean the safety grid with a damp cloth.
4. Empty the powder container.
5. Remove the dosing tongue. To do this, remove the star nut located to the left of the powder discharge.
6. Clean the dosing tongue with a damp cloth and then dry the dosing tongue.
7. Use a dry brush and the supplied cleaning scraper to remove the milk powder deposits in the powder container and at the powder discharge opening.
8. Reinstall the dry dosing tongue. Retighten the star nut located to the left of the powder discharge.
9. Reinstall the safety grid. Retighten the screws.
10. Only add milk powder (MP) to the powder container if you want to recommission the automatic feeder immediately.
11. Insert the mains plug and switch the automatic feeder on again using the Control switch .
12. Enable milk powder dosing to fill the dosing star and the dosing unit.
 - 12.1. Navigate via  > **Diagnostics** to the **Powder motor** sub-menu and press , to start the motor.
13. Calibrate the milk powder (MP) (see 10. "Calibration" - 97).
The automatic feeder is now ready for operation again.

 **DANGER!**

Fatal electric shock.

The electrical components of the automatic feeder are live.

- ▶ Switch the automatic feeder off using the control switch and disconnect the power plug before you reach into the powder container.



 **WARNING!**

There is a risk of injury due to automatic start-up.

The powder mixing unit can start up automatically at any time, crushing or cutting off your fingers.

- ▶ Do not reach into the hazardous area of the powder mixing unit. Switch the automatic feeder off using the control switch before you reach into the powder container.

To clean the powder container, proceed as follows:

1. Switch the automatic feeder off using the control switch and disconnect the power plug.
2. Remove the screws that hold the safety grid and remove it.
3. Clean the safety grid with a damp cloth.
4. Empty the powder container.
5. Remove the dosing tongue. To do this, remove the star nut located to the left of the powder discharge.
6. Clean the dosing tongue with a damp cloth and then dry the dosing tongue.
7. Use a dry brush and the supplied cleaning scraper to remove the milk powder deposits in the powder container and at the powder discharge opening.
8. Reinstall the dry dosing tongue. Retighten the star nut located to the left of the powder discharge.
9. Reinstall the safety grid. Retighten the screws.
10. Only add milk powder (MP) to the powder container if you want to recommission the automatic feeder immediately.
11. Insert the mains plug and switch the automatic feeder on again using the control switch.
12. Enable milk powder dosing to fill the dosing star and the dosing unit.
 - 12.1. Navigate via  > **Diagnostics** to the **Powder motor** sub-menu and press , to start the motor.
13. Calibrate the milk powder (MP) (see 10. "Calibration" - 97).

The automatic feeder is now ready for operation again.

7. Transmitter and animal management

All menus for management of the list of all transmitters and the calves registered at the feeder can be found via  > **Animal management**.

7.1 Managing the transmitters

7.1.1 Basics

7.1.1.1 Identification process at the station

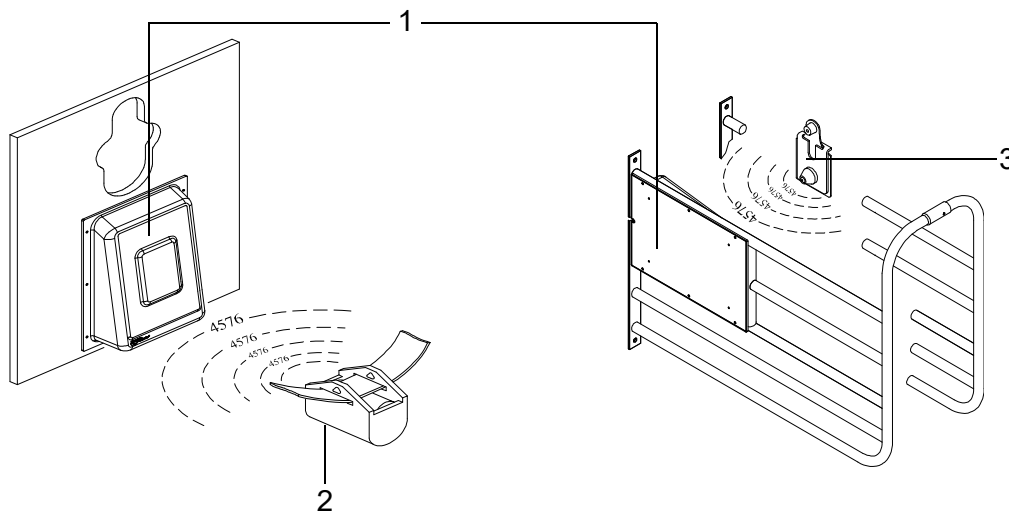

- 1 Antenna
- 2 Collar transmitter
- 3 Earmark transmitter

For identification purposes, each calf wears a collar with a transmitter or an earmark with a transmitter. The transmitter has a multi-digit number, which is also usually stamped into the transmitter housing. This **transmitter number** is sent from the transmitter to the antenna, which is part of the feeding box.

Note: Calves without collars should never be in the bay. They could push other animals out of the way and steal remaining amounts of feed.

Connection of transmitters and animal numbers

The multi-digit transmitter number is not well suited for the rapid location of individual calves. For this reason, a calf is issued an animal number along with the transmitter number. The animal wears this animal number on an easily readable collar, or the animal number is put on the earmark where it can be easily read. Up to 250 different animal numbers of up to six digits can be assigned to the calves.

7.1.2 Creating transmitter numbers

When the feeder is being commissioned, existing transmitters have to be created once in the system. When you do this, each transmitter number is assigned one animal number of no more than six digits. These animal numbers are then available and can be used to register the calves.

7.1.3 Reading transmitter numbers

When creating new transmitter numbers, it is a good idea to have these read by the feeder. This saves you from typing in the numbers and eliminates the possibility of typing errors.

You read transmitter numbers in the automatic feeder as follows:

1. Navigate via  > **Animal management** > **Transmitters** to the **New** sub-menu.
2. Hold a transmitter next to the identification unit of a feeding box.

The number of the transmitter will be read in and displayed in the line after **No. †**. At the same time, the animal number to be newly assigned will be suggested in the **Animal no.** line.

Note: You can affect the suggested animal number by selecting in the **No.** line **automatic** or **sequential** as the scheme for assigning the animal numbers (see 7.1.5 "Assigning animal numbers" - 59).

3. Check whether the suggested **animal number** is correct and if so go to the line **accept?** and press .





Note: Make sure that in **Station** you select the feeding box within which you have located the transmitter which you have identified.

4. In order to allocate the newly read transmitter number to the displayed animal number, confirm the security prompt **Create new no. xxx for animal xx?** by choosing .

7.1.4 Manually entering transmitter numbers

Instead of reading the transmitters, you can also manually type in the transmitter numbers, if necessary

You manually enter transmitter numbers as follows:

1. Navigate via  > **Animal management** > **Transmitters** to the **New** sub-menu.
2. Enter the transmitter number in the **No. †** menu and confirm it by choosing .
3. In the **Animal No.** menu, check the suggested animal number and confirm it by choosing .
4. Confirm **accept?** by choosing .
5. In order to allocate the input transmitter number to the displayed animal number, confirm the security prompt **Create new no. xxx for animal xx?** by choosing .

7.1.5 Assigning animal numbers

If the transmitter numbers are automatically read when new numbers are created, an animal number will be automatically suggested. When doing this, there are two schemes to choose from for the assignment of numbers.

7.1.5.1 Consecutive assignment of animal numbers

There is a counter which counts up for each new transmitter number as it is read. In this way, all of the transmitter numbers that are registered by the identification function are linked to consecutive animal numbers; e.g., from 1 to 50.

You set up consecutive assignment of animal numbers as follows:

1. Navigate via  > **Animal management** > **Transmitters** to the **New** sub-menu.
2. Select the **consecutive** option in **No.**
3. If necessary, in the **next** menu, specify the animal number at which you want automatic reading of transmitters to start.

Note: If you use collars, it makes sense to start with 1 and read in the transmitters in order.

7.1.5.2 Assignment of animal numbers based on transmitter numbers

More and more often, calves are already equipped with an electronic earmark transmitter when they are born and keep this earmark their whole lives. The automatic feeder program has been adapted for this type of transmitter so that the registration process of the transmitters and calves can take place completely automatically.

You set up automatic assignment of animal numbers as follows:

1. Navigate via  > **Animal management** > **Transmitters** to the **New** sub-menu.
2. Select the **automatic** option in **No.**
3. In the **Range** menu, define the part of the transmitter number that you would like to use as the animal number. The animal number can have a maximum of six digits.

For example: 5-2 means that, counting from the right, the second to the fifth digits of the transmitter number will be used as the animal number. **6-1** means that, counting from the right, the first to the sixth digits of the transmitter number will be used as the animal number.



7.1.6 Editing transmitters or animal numbers

If necessary, (e.g., if a transmitter is lost), a transmitter number can be subsequently changed or deleted.

7.1.6.1 Changing the transmitter number



Manually changing the transmitter number

You manually change a transmitter number as follows:

1. Navigate via  > **Animal management** > **Transmitters** to the **Edit** sub-menu.
2. Select the transmitter number to be changed.
3. Change the transmitter number in the **No.** menu and confirm by choosing .



Reading the new transmitter number for the change

You read a new transmitter number as follows:

1. Navigate via  > **Animal management** > **Transmitters** to the **Edit** sub-menu.
2. Select the transmitter number to be changed.
3. Confirm **read?** by choosing .
A new menu is displayed, and the transmitter number flashes in the first line.
4. Hold the transmitter that you want to read next to the identification unit.
The number is automatically accepted in the first line.
5. Confirm **accept?** by choosing .



7.1.6.2 Changing the animal number

Like the transmitter number, the animal number can also be changed.

1. Navigate via  > **Animal management** > **Transmitters** to the **Edit** sub-menu.
2. Select the animal number you would like to change.
3. In the **Animal No.** menu, change the animal number that is currently allocated to the transmitter and confirm by choosing .

7.1.6.3 Deleting transmitter numbers

You delete transmitter numbers as follows:

1. Navigate via  > **Animal management** > **Transmitters** to the **Edit** sub-menu.
2. Select the transmitter number to be deleted and confirm **Delete** by choosing .

Note: You can only delete transmitter numbers of calves that are not registered (= status: available).

7.1.7 Deleting the transmitter number when canceling an animal

Generally, the collars (or earmarks) with the respective transmitters remain at the organization and are reused after the calf is taken out of the pen and its registration is canceled. For this reason, the default setting when canceling the registration of a calf is to not delete its transmitter number. If the calf's transmitter is, however, **not** reused but rather stays with the calf, (lifelong earmark), make the following setting in the feeder:

1. Navigate via  > **Animal management** > **Cancellation** to the **Settings** sub-menu.
2. Select the **yes** option in the **Delete no.** menu

When a calf's registration is canceled, the transmitter number is also deleted along with the animal number. This prevents an accumulation of unused transmitter numbers, which would use up the available storage space.

7.1.8 Calling up the transmitter statistics

You call up a transmitter statistic as follows:

1. Navigate via  > **Animal management** > **Transmitters** to the **Information** sub-menu.
2. An overview of the transmitters created in the system is displayed.
 - 2.1. In the **Registered** menu you check the number of registered transmitters or calves.
 - 2.2. In the **Available** menu you check the number of available transmitters.
 - 2.3. In the **Free** menu you check how many transmitters you can still create.

7.2 Registering animals

Calves are only fed at the feeder if they are also registered there. You can either manually register each calf or instruct the feeder to automatically register the calves. In the latter case, the calf is registered as soon as it enters the feeding station for the first time. This means that the manual registering of the calves is not needed.

During registration, the calf is allocated to one of four groups, A to D. The calf will then be fed in accordance with the feed, concentration and milk ratio plans of this group.

The group to which you allocate the calves depends solely on the feed quantity, the concentration and the milk ratio it is desired to dispense to the calves. In this case, it does not matter which station the calves consume their feed in or which bay the calves have been housed in.

If you house two groups of animals, and one group will receive milk only and the other will receive MP only, allocate these calves to different feeding groups.

7.2.1 Manual registration of animals

You register animals manually as follows:

1. Navigate via  > **Animal management** > **Registration** to the **Animals** sub-menu.
2. Select one of the available (not yet registered) animal numbers.
3. In Group, select the group to which the calf is to be allocated.
4. If the total feeding duration for the animal is to be shortened, you can set this under Correction days (see 8.4.6 "Shortening or lengthening total feeding duration").
5. Confirm **Register?** by choosing .
6. Confirm the prompt **Register animal xx in group X?** by choosing .

Note: On its registration day, the animal receives the exact amount of feed, spread over the course of the day, as intended for the first day according to the feeding plan. If you have entered correction days, the animal will receive the feed that is intended for the corresponding day.

Note: For the next manual registration, the values last set will again be shown and can be used or changed for the current animal.

7.2.2 Automatically registering animals

If an animal that is not yet registered enters the feeding station for the first time, it can then be automatically registered. For automatic registration, three different modes can be set which are described in detail in the following three sub-sections. The following table presents an overview of this.

Overview of the three modes for automatic registration

Automatic registration mode	Transmitter number being identified	
	available	unknown
deactivated	Warning unknown transmitter	Warning unknown transmitter
available transmitters	Animal will be registered	Warning unknown transmitter
all transmitters	Animal will be registered	Transmitter is created, new animal number is assigned, animal is registered

7.2.2.1 Deactivating automatic registration

Automatic registration is deactivated by default. You can restore this setting at any time.

You deactivate automatic registration as follows:

1. Navigate via  > **Animal management** > **Registration** to the **Automatic** sub-menu.
2. Select **Mode no** and confirm by choosing . Automatic registration is then deactivated.

Note: When the registration function is deactivated, the **unknown transmitters warning** will be triggered if an unregistered calf enters a station.

7.2.2.2 Register available transmitters only automatically

Automatic registration shortens the registration process for the calves. When doing this, you can specify that only calves whose transmitter numbers are already in the system can be registered. If an available transmitter number is registered in the identification unit, the corresponding calf will be registered automatically. Calves or transmitter numbers that have not yet been created in the system will trigger the **Unknown transmitter number** warning.

Proceed as follows to set up automatic registration of available transmitters:

1. Navigate via  > **Animal management** > **Registration** to the **Automatic** sub-menu.
2. In **Mode** select the **available** option.
3. In **Group**, choose the group in which you want to automatically register the calves.

Note: The registration of calves that are to be removed should only be canceled after they have left the bay, as they will otherwise automatically be re-registered when they enter the station and will then be returned to the start of the feeding plan.

7.2.2.3 Creating transmitter numbers and automatically registering calves

To shorten the registration process even more, you can specify that calves can also be registered if their transmitter numbers are not known in the system. This eliminates the need for reading or manual entry of transmitter numbers. In this case, if an unknown transmitter number is registered in the identification unit, this transmitter number is automatically created in the system and a new animal number is issued and registered at the same time.

Note: When newly creating transmitters and animal numbers, the animal number will either be produced consecutively or as a part of the transmitter number (see 7.1.5 "Assigning animal numbers" - 59).

Proceed as follows to create transmitter numbers and automatically register calves:



1. Navigate via  > **Animal management** > **Registration** to the **Automatic** sub-menu.
2. In **Mode** select the **All** option.
3. In **Group**, choose the group in which you want to automatically register the calves.

7.3 Canceling animals or animal groups

Individual calves or a group of calves that are no longer being fed according to the plan must be removed from the pen compartment and their registration canceled. The same applies to calves whose feeding plan has expired.

7.3.1 Canceling individual animals

You cancel an individual animal's registration as follows:

1. Navigate via  > **Animal management** > **Cancellation** to the **Animals** sub-menu.
2. Select the desired animal number.
3. In the **Plan end** menu, you check how much longer the calf is to be fed according to the plan.
4. In the **MP** menu, you can check how much milk powder the calf has consumed from the start of registration to its cancellation.
5. In the **Milk** menu, you can check how much milk the calf has consumed from the start of registration to its cancellation.
6. Confirm Cancel? by choosing , to cancel the calf's registration.

NOTICE!

There is a risk of malnutrition if calves do not receive any feed.

Malnutrition can cause impaired growth and development, increased susceptibility to illness or even death of the calves.

- ▶ You must use an alternative method to supply your calves with feed.

Note: If you have chosen the value All or Available for the automatic registration mode, you should remove unregistered calves from the bay, because otherwise they will be automatically registered again.

7.3.2 Canceling a group

You can cancel a group registration as follows:

1. Navigate via  > **Animal management** > **Cancellation** to the **Group** sub-menu.
2. Select the required group.
3. In the **Registered** menu you can see how many calves are being fed according to the corresponding plan.
4. In the **Weaned** menu you can see how many calves have finished the feeding plan and are therefore no longer receiving any feed.
5. Confirm **Cancel?** by choosing , if all calves of the group are to be canceled regardless of whether they are registered or weaned calves.
6. Confirm the security prompt **Cancel animals in group?** by choosing .

7.3.3 Canceling weaned animals

You can cancel the registration of weaned calves as follows:

1. Navigate via  > **Animal management** > **Cancellation** to the **Weaned calves** sub-menu.
2. Confirm **Cancel?** by choosing , if weaned animals are to be canceled.
3. Confirm the security prompt **Cancel animals?** with .

7.4 Changing the registration of animals

You can transfer calves registered at an automatic feeder to another group at any time.

To change a registered calf to another group, proceed as follows:

1. Navigate via  > **Animal management** to the **Change registration** sub-menu.
2. Select the desired calf.
3. Select the desired feeding group in **Group**.
4. Confirm the prompt **Change registration of animal xx into group X?** by choosing .

Note: When registration is transferred, the feeding day is retained; the calf will not be reset to the start of the feeding plan (= to plan day 1).

8. Feeding

You may only use the automatic feeder to prepare liquid feed for your calves.

Note: If you have installed additional peripheral devices such as the additive dispenser, you must also follow the instructions in the operating manual for these devices.

8.1 Replenishing feed

To ensure that the automatic feeder can prepare feed, you must make sure that the powder container and the milk tank are always full.

8.1.1 Filling the milk powder container

Fill the container only with milk powder (MP) that is suitable for feeding calves.

CAUTION!

Beware of the health hazards caused by lifting heavy loads.

- ▶ When filling the powder container make sure you do not strain yourself. If necessary, use appropriate lifting aids.

NOTICE!

Make sure that no paper or other foreign bodies enter the powder container.

The dosing mechanism could otherwise be damaged or the dosage accuracy impaired. As a result, your calves could receive insufficiently concentrated feed and would not be supplied with any or sufficient feed. This can lead to malnutrition, which can cause impaired growth or development, increased susceptibility to illness or even the death of your calves.

NOTICE!

A warning that the powder container is empty is issued only if a powder sensor (optional) is fitted!

Otherwise feeder operation continues without any milk substitute. This can result in your calves only receiving water. This can lead to malnutrition, which can cause impaired growth and development, increased susceptibility to illness or even the death of your calves.

8.1.2 Filling the milk tank

Ensure that the milk you are feeding is always clean. Straw, hay or other foreign matter impair the functioning of the automatic feeder.

Note: Use a low-speed intermittent stirrer for cow's milk and flocculated milk to prevent the milk from creaming. Stirrers that run constantly or at high speed churn the milk into butter.

Cool the milk or acidify it with formic acid.

Note: When setting the concentration, always follow the instructions of the formic acid manufacturer.

NOTICE!

Only heat milk in the automatic feeder if its acidification process has been fully completed.

The stainless steel coil of the heat exchanger could become clogged.

8.2 Feed preparation

During preparation of feed, the liquid components are dispensed first. These are fed via the boiler or heat exchanger where they are heated, then transferred to the mixer beaker.

In the heat exchanger, water that was heated in the boiler transfers its heat to the liquid (milk or water) present in the stainless steel coil of the heat exchanger. A circulation pump keeps the boiler water in motion. To save energy, the circulation pump does not operate continuously.

If the mixer beaker is filled up to the rod electrode with fluid (water or milk), milk substitute (MP) will be dispensed from the powder container into the mixer beaker according to the feeding plan.

8.2.1 MP mode or milk mode

In the **Operating modes** menu you set the type of feed to be dispensed:

- The automatic feeder dispenses MP feed only. **[MP only]**.
- If you want the combined automatic feeder to dispense MP feed only, always configure this via **Operating modes**.

NOTICE!

The automatic feeder will malfunction if you set the feeder type to Powder during setup.

This can lead to malnutrition. Malnutrition can cause impaired growth and development, increased susceptibility to illness or even the death of your calves.

- The amount of water specified in the feeding plan is heated up in the heat exchanger and dispensed into the mixer beaker.
- The amount of milk substitute specified in the feeding plan is dispensed into the mixer beaker from the powder container.
- The mixer mixes this portion into a homogeneous liquid.
- The automatic feeder dispenses milk and MP feed. **[MP/milk]**.

The automatic feeder can add milk substitute to milk or dilute milk with water in order to obtain the concentration you require.

- The amount of water specified in the feeding plan is heated up in the heat exchanger and dispensed into the mixer beaker.
- The amount of milk specified in the feeding plan is channeled from the storage container into the heat exchanger, heated up and dispensed into to the mixer beaker.
- The amount of milk substitute specified in the feeding plan is dispensed into the mixer beaker from the powder container.
- The mixer mixes this portion into a homogeneous liquid.

You set the feed mode as follows:

1. Press  > **Device data** > **Operating modes**.
2. In the Feeds menu select the option **MP/Milk** or **MP**.
If you choose **MP/milk**, further menus are displayed:
3. In the **Milk empty:** menu, select
 - 3.1. **Stop**. When the milk tank is empty, the automatic feeder automatically switches completely off.

NOTICE!

Your calves will not receive any feed if feeder operation is interrupted. This can lead to malnutrition.

Malnutrition can cause impaired growth and development, increased susceptibility to illness or even death of the calves.

- ▶ You must immediately refill an empty milk tank or use an alternative method to provide your calves with feed.

-
- 3.2. **MP**. When the milk tank is empty, the automatic feeder switches to MP mode.

NOTICE!

Your calves will not receive any feed if feeder operation is interrupted. This can lead to malnutrition.

Malnutrition can cause impaired growth and development, increased susceptibility to illness or even death of the calves.

- ▶ You must ensure that the storage container for milk substitute is always filled with milk substitute.

-
4. In the **Dry matter** menu, you enter the desired value for the milk substitute. You can enter values between 5 g and 255 g. The default value is 150 g.

The degree of milk dry matter is compared to the concentration plan every day. If the desired feed concentration is greater than the DS content of the milk (compensation), then MP will be added to the mixer beaker until the set concentration is reached. If the desired concentration is lower than the DS content of the milk (compensation), then the milk or milk/MP feed mixture will be thinned with water.

5. In the **Expulsion** menu, you specify how long a warm portion of milk should remain ready for consumption in the stainless steel coil of the heat exchanger before it is replaced with a water portion. You can enter values between 0 and 3 hours. The default value is 1 hour. The pause time starts after the last milk portion is dispensed. If the value 0 is selected, then **Expulsion** is deactivated.

NOTICE!

Warm milk that remains too long in the stainless steel coil of the heat exchanger is a breeding ground for germs.

- ▶ Do not change the default value, if possible.

NOTICE!

Warm milk that remains too long in the stainless steel coil of the heat exchanger can thicken and block the heat exchanger.

This can lead to malnutrition. Malnutrition can cause impaired growth and development, increased susceptibility to illness or even the death of your calves.

- ▶ Do not change the default value, if possible.

8.2.2 Feed distribution

For an internal station, feed is distributed in **preference mode**.

In preference mode, one animal is always fed after the other. When the calf sucks the feed, the mixed feed in the mixer is conveyed to the sucking teat via the suction hoses and the opened feeding box valve.

8.3 Feeding

When you register your calves for the automatic feeder, you assign them to a group (A, B, C or D). Calves in the same group are usually fed according to the feeding plan of their group. See the appendix for examples of default feeding plans (see 14.1 "Standard feeding plans" - 122).

You can also choose between rationed feeding and 40FIT feeding.

8.3.1 40FIT feeding

A key goal of calf rearing is to ensure that calves get off to the best possible start in life and to prepare them for optimum performance as milk cows later in life. Intensive feeding in the first 40 days of life is an important prerequisite in reaching this goal.

By changing the feeding plan to 40FIT/rationed, you can activate the 40FIT function in any period. During this period, feed is freely available to calves all day long. The defined feed quantity is only a reference value for calculating alarm levels and is not a limit.

To ensure that the calves do not drink too much, the amount consumed per visit is limited by the defined maximum quantity. In addition, a blocking period can be defined during the 40FIT feeding phase. This means that the calf can only consume the defined maximum quantity during this period. After the subsequent blocking period, the maximum quantity can be consumed again, and the remaining amounts from the previous blocking period are not carried over.

If a feeding period is defined as rationed, the feed quantity to which the calf is entitled is spread across multiple intervals.

The standard A and B feeding plans correspond to the 40FIT feeding concept. The standard A and B feeding plans correspond to the rationed feeding concept.

Note: Contact your feed consultant to find out which feeding plan is best for your calves.

8.3.2 Interval feeding program





The feed quantity to which the calf is entitled each day is spread across multiple intervals. (**Interval feeding program**). Feed entitlements are saved from interval to interval and can be consumed at any time once a **minimum saved amount**. Without a minimum saved amount, the calves would consume feed portions that are too small. The feed portion is not released until the minimum saved amount defined in the feeding plan has been reached. As a result, the minimum saved amount lets you indirectly define the number of meals that a calf receives. From 20:00 hours to 24:00 hours, a calf can consume the rest of the feed to which it is entitled, even if it has not reached the minimum saved amount. By defining the maximum amount in the plan, you ensure that a calf does not drink too much. You use the **maximum amount** in the feeding program to define how much feed a calf can consume at once. The interval feeding concept is tailored to the needs of your calves. You can set up the feeding plan so that young calves are supplied with several small portions, e.g., 1.5 ltr of feed 4 times a day, at the beginning of the feeding period. When the calves get older, you reduce the number of feeding times by increasing the minimum saved amount to 1 feeding time per day. The increasing intervals between the feeding times encourage the consumption of concentrate and roughage. At the same time, you reduce the tendency toward cross-sucking. See the appendix for an example of an interval program (see 14.2 "Basic principle of interval feeding" - 124). After consuming its maximum quantity, a calf is excluded from feed distribution for 2 hours, and saved feed quantities are retained.

8.3.3 Preferred feeding

You can give preference to certain calves for the consumption of feed. If a preferred calf enters a feeding box, its feed is immediately dispensed. You can give calves preference based on the following criteria:

- Calves that have triggered an **alarm**.
- All calves up to a certain **feeding day**.
- One **station** and all calves that feed there.







You set a preference as follows:

1. Navigate via  > **Feeding** to the **Preference** sub-menu.
2. In the **Alarm** menu, choose   **[yes]** to prefer or **[no]** not to prefer calves with alarm messages.
3. In the **until feed day** menu, enter the feeding day until which you want to give a calf preference.
4. In the **Station** menu, choose   to select the feeding box at which preferred feeding is to take place, or select **[none]**.

8.3.4 Extra portion

You can manually start the preparation of extra portions at any time. Extra portions are dispensed to a calf in addition to the daily quantity to which it is entitled according to the quantity plan. These portions are not offset against the quantity plan.

You enable dispensing of extra portions as follows:





1. Navigate via  to the **Extra portion** sub-menu.
2. In the Output menu, choose   the location for the output:
 - 2.1. In the **Bucket** menu, you output the feed portion into a prepared bucket via the gully drain.
 - 2.2. In the **Mixer** menu, you output the extra portion into the mixer.
Change over the mixer contents manually and after each **Mixer empty?** partial portion confirm with .
 - 2.3. In the **Station X** menu, you output the extra portion via the selected valve outlet.
Select a **feeding box** and disconnect the hose from the valve outlet. Drain the feed into a container suitable for feeding calves.
3. In the **Set quantity** menu, specify the quantity for the extra portion. You can enter values between 0.3 ltr and 65 ltr. The default setting is 5 ltr.
4. In the **Temperature** menu, specify the required temperature for the extra portion. The temperature must not exceed 45 °C. The value you selected via  > **Device data** > **Portion** > **Set Temp.** is the pre-set value.
5. In the **Concentr.** menu, specify the required concentration for the extra portion to be mixed. You can enter values between 5 and 255 g/l. The default setting is 150 g/l.
6. In the **Milk ratio** menu, specify the milk ratio for the extra portion. You can enter values between 0% and 100%. The default setting is 100%.
7. In the **Additive** menu (optional), specify the amount of additive for the extra portion. You can enter values between 1 g/ltr and 99 g/ltr.
8. Confirm **Start?** , in order to start dispensing the extra portion.

8.4 Checking and changing feeding data for individual animals

In the **Single animal** menu, you check and change feeding parameters for individual calves.

8.4.1 Group membership

You allocate a registered calf to a group as follows:

1. Navigate via  > **Feeding** to the **Individual animal** sub-menu.
2. Use  , to select the desired animal number.
3. In the **Group** menu, choose   A, B, C or D.

The prompt **Transfer animal no. into group [A, B, C or D]?** will appear.

4. Confirm the prompt by choosing .

The calf is registered in the required group.

8.4.2 Feed quantity

You change the feed quantity for an individual calf as follows:

1. Navigate via  > **Feeding** > **Individual animal** to the **Feeds** sub-menu.
2. In the **Deviation** menu, enter the number of days (validity period) on which the calf is to receive a modified feed quantity. You can enter values between 0 and 99. The default setting is 0 days.
3. In the **Quantity** menu, you enter the additional feed quantity that the selected calf is to receive. You can enter values between 0 and 25 l. Use the (+/-) key to enter a minus sign (-) in front of the number, for example -2 l, in order to reduce the feed quantity and a plus sign (+), for example +2 l, to increase it. The default setting is 0.0 ltr.
4. In the **Plan** menu, you can check the feed quantity to which the calf is entitled according to the plan.
5. In the **Feed** menu, you can check the feed quantity to which the calf is entitled for the defined period.

After the validity period, your corrections will expire and the calf will again be fed according to the feeding plan of its group.

8.4.3 Feed concentration

You change the feed concentration for an individual calf as follows:

1. Navigate via  > **Feeding** > **Individual animal** to the **Concentration** sub-menu.
2. In **Deviation**, enter the number of days (validity period) on which the calf is to receive a modified feed concentration. You can enter values between 0 and 99. The default setting is 0 days.
3. In the **Quantity** menu, you enter the required change in concentration. You can enter values between 0 g/ltr and 255 g/ltr. Use the (+/-) key to enter a minus sign (-) in front of the number, for example -10 g/ltr, in order to reduce the concentration and a plus sign (+), for example +10 g/ltr, to increase the concentration. The default setting is 0 g/l.
4. In the **Plan** menu, you can check the feed concentration to which the calf is entitled according to the plan.
5. In the **Concentration** menu, you can check the feed concentration to which the calf is entitled after the change.

After the validity period, your corrections will expire and the calf will again be fed according to the feeding plan of its group.

8.4.4 Milk share

Here you can view the milk ratio but you cannot change it.

You check the milk ratio as follows:

1. Navigate via  > **Feeding** to the **Individual animal** sub-menu.
2. In the **Milk ratio** menu, you can view the milk ratio percentage

8.4.5 Weight





You set the weight as follows:

1. Navigate via  > **Feeding** to the **Individual animal** sub-menu.
2. In the **Weight** menu, you set the weight of the animal.

8.4.6 Shortening or lengthening total feeding duration

You can shorten or lengthen the total feeding duration for a calf. To do this, you must "move" the animal to the desired plan day.

You change the total feeding duration as follows:

1. Navigate via  > **Feeding** to the **Individual animal** sub-menu.
2. Use  , to select the desired animal number.
3. In the **Plan day** menu, you can check which day the calf is on in the feeding plan.
4. Confirm the **Plan day** by choosing .
5. In the **Feed. day** menu, you can check the number of days that have passed since the calf was registered.
6. In the **Correction** menu, you enter the number of days by which you want to reduce or extend the feeding duration according to the group feeding plan for the calf. The maximum possible extension corresponds to the number of feeding days.
Note: To extend the feeding duration, use the (+/-) key to enter a negative number such as -2. To shorten the feeding duration, use the (+/-) key to enter a positive number such as +2.
7. In the **Plan day** menu, you can check the calf's new plan day.
8. In the **Plan end** menu, you can view the number of days after which the feeding plan will end.
9. In the **Feed** menu, you can check the feed quantity that the calf will receive on the current day (today).
10. In the **Conc.** menu, you can view the feed concentration that the calf will receive on the current day (today).
11. In the **Milk ratio** menu, you can check the milk ratio that calf will receive on the current day (today).

12. In the **Initial** menu, the calf's initial weight is shown.

13. In the **Date** menu, the calf's arrival date is shown.

8.5 Feeding plans

The following plans are taken into account when the feed is prepared:

- Quantity plan
- Concentration plan
- Quantity limitation plan
- Milk ratio plan

When you registered your calves for the automatic feeder, you assigned them to a group (A, B, C or D). A quantity plan, a concentration plan, a quantity limitation plan and a milk ratio plan are created for each group.

If you are running an automatic feeder with animal identification, calves from different feeding groups, for example group A and group B, can be housed in the same bay or consume feed at the same station.

Below is an example of a feeding plan.

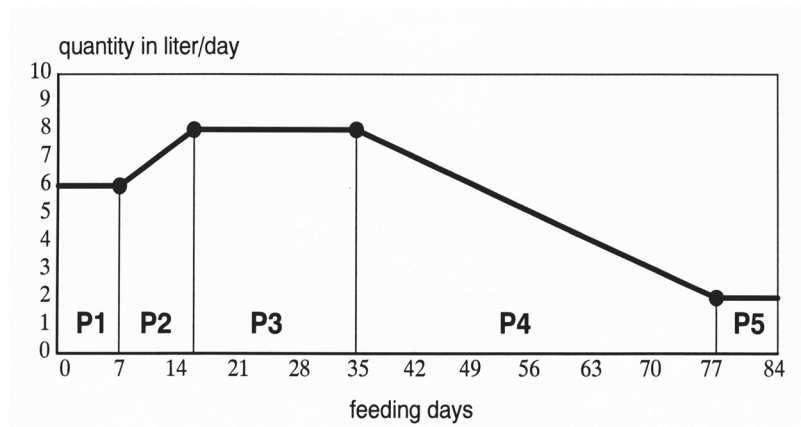

You can divide each feeding plan into up to 5 periods (P1, P2, P3, P4 and P5).

The day on which a calf is registered corresponds to the first day of its feeding plan (if no correction days were entered).

Your automatic feeder has preset default plans. You can find the default feeding plans in the appendix of this operating manual (see 14.1 "Standard feeding plans" - 122). These default plans are based on general experience. Only change default plans if, based on your experience in calf rearing and your rigorous monitoring efforts, you are certain that your calves will not suffer from undernourishment or malnutrition. Malnutrition can cause impaired growth or development, increased susceptibility to illness or even the death of your calves.

8.5.1 Changing the default quantity plan

You can alter the default quantity plan according to 2 different feeding principles: the 40FIT feeding principle (F) or the rationed feeding principle (R).

Depending on the feed entitlement, the feed is distributed across one or more portions. These portions can vary in size. Only the feed amount that is actually consumed is recorded.







NOTICE!

If you deviate from a default quantity plan, a calf may not receive sufficient feed.







This can lead to malnutrition, which causes impaired growth and development, increased susceptibility to illness or even the death of your calves.

► Consult your feed consultant before making changes that could have harmful effects.

Proceed as follows to change a default quantity plan based on the 40FIT feeding concept:

1. Navigate via  > **Feeding** > **Plans** > **Feeds** to the **Feeding times** sub-menu.
2. Use   to select the desired group.
Groups A and B are assigned to 40FIT plans by default.
The default feeding plan of this group is shown in the display.
3. Press  and choose   to select the feeding principle for the group: **40FIT/rationed**
4. In the **Days (P1)** column, enter the length of the feeding period. You can enter values from 2 to 99 days. The default setting is 35 days.
5. In the **from (P1)** column, enter the starting value for the feeding quantity. You can select values from 0.1 to 25.5 liters in 0.1 liter increments. The default setting is 6 liters.
Note: The quantity entered here is not a limit, but a reference value for calculating alarm levels for 40FIT feeding (F) or as a limit for rationed feeding (R).
Note: Comply with the table in chapter 8.5.2 "Changing the default concentration plan" - 76.
6. In the **to (P1)** column, enter the final value for the feeding quantity. You can select values from 0.1 to 25.5 liters in 0.1 liter increments. The default setting is 8 liters.
Note: The quantity entered here is not a limit, but a reference value for calculating alarm levels for 40FIT feeding (F) or as a limit for rationed feeding (R).
Note: Comply with the table in chapter 8.5.2 "Changing the default concentration plan" - 76.
7. Activate 40FIT feeding at the end of a period by choosing **F** or activate rationed feeding by choosing **R**.
If necessary, repeat steps 1 to 7 for **P2** to **P5**.
8. In the **Duration** menu, you can check the total duration of the feeding plan.
9. In the **Quantity** menu, you can check the total feed quantity that a calf will receive according to this plan.
Note: This quantity is a guide value for 40FIT feeding.

Proceed as follows to change a default quantity plan based on the rationed feeding concept:

1. Navigate via  > **Feeding** > **Plans** > **Feeds** to the **Feeding times** sub-menu.
2. Use   to select the desired group.
Groups C and D are assigned to rationed feeding plans by default.
The default feeding plan of this group is shown in the display.
3. Press  and choose   to select the feeding principle for the group: **rationed**
4. In the **Days (P1)** column, enter the length of the feeding period. You can enter values from 2 to 99 days. The default setting is 2 days.
5. In the **from (P1)** column, enter the starting value for the feeding quantity. You can select values from 0.1 to 25.5 liters in 0.1 liter increments. The default setting is 5 liters.
Note: The quantity entered here serves as a limit.
Note: Comply with the table in chapter 8.5.2 "Changing the default concentration plan" - 76.
6. In the **to (P1)** column, enter the final value for the feeding quantity. You can select values from 0.1 to 25.5 liters in 0.1 liter increments. The default setting is 5 liters.
Note: The quantity entered here serves as a limit.
Note: Comply with the table in chapter 8.5.2 "Changing the default concentration plan" - 76.
7. If necessary, repeat steps 4 to 6 for **P2** to **P5**.
8. In the **Duration** menu, you can check the total duration of the feeding plan.
9. In the **Quantity** menu, you can check the total feed quantity that a calf will receive according to this plan.

8.5.2 Changing the default concentration plan

There is a concentration plan for every feeding plan. Just like the feeding plan, the concentration plan can be divided into 5 periods. The default setting is one period, **P1**. The length of the quantity plan periods is, however, not bound to the length of the feeding plan periods.

For example, if you want to keep the feed concentration the same for all feeding periods, in **P1** in the **Days** column, you can enter the same number that is specified for the total number of feeding days in the **Duration** menu option.

The default milk substitute concentration is **150 g/ltr**. Periods **P2** to **P5** are not activated by default.

Note: Many milk powder manufacturers recommend the **MP concentration** (MP = milk substitute) **per liter of feed** on their packaging. However, the program of the automatic feeder requires you to enter the **MP concentration per liter of water**. To make this conversion easier, use the following conversion table, which is also included in the appendix (see 14.3 "Milk powder (MP) conversion table" - 124).

Required concentration (in g/ltr of feed)	Setting in concentration plan (in g/ltr of water)	Dry matter (in %/ltr of feed)
100	111	10.0
105	117	10.5
110	124	11.0
115	130	11.5
120	136	12.0
125	143	12.5
130	149	13.0
140	163	14.0
150	176	15.0
160	190	16.0
170	205	17.0
180	220	18.0
190	235	19.0
200	250	20.0

For example: The feed concentration specified on the of the milk substitute (MP) package is **130 g/l feed**. When you enter the feed concentration plan in your automatic feeder, enter **149 g/l** (water) according to the conversion table.

Required concentration (in g/ltr of feed)	Setting in concentration plan (in g/ltr of water)	Dry matter (in %/ltr of feed)
125	143	12.5
130	149	13.0
140	163	14.0

*) Guide value

NOTICE!

If you deviate from the default concentration plan, a calf could receive feed which is insufficiently concentrated.



This can lead to malnutrition, which causes impaired growth and development, increased susceptibility to illness or even the death of your calves.

- Ensure that the changes are not having any harmful effects, for example by rigorously monitoring your calves.

Calves that only receive milk or milk substitute must be registered in different feeding groups because there is only one default concentration plan per group.

The length of the concentration plan periods does not have to match the length of the quantity plan periods. If the concentration plan is shorter than the quantity plan, at the end of the concentration plan a message will appear in the display of your hand terminal. The concentration of the last feeding portion fed to the calf will be maintained until the end of the quantity plan.

You change a default concentration plan as follows:

1. Navigate via  > **Feeding** > **Plans** > **Feeds** to the **Concentration** sub-menu.
2. Use   to select the desired **Group** (A, B, C or D).
The default concentration plan of this group will be shown in the display.
Note: Unlike for the quantity plan, only P1 is assigned by default. However, here too, you can activate up to 5 periods (**P1** to **P5**). If you activate a period, for example P2, the following period P3 will automatically become visible.
3. In **P1**, you enter the duration (**Days** column) of the change in concentration and the respective starting value (**from** column) and final value (**to**) of the feed concentration. You can enter values between 5 and 255 g. The default setting is 150 g.
4. In **Duration**, you can check the total duration of the concentration plan.
5. In **Quantity**, you can check how many kilograms of milk substitute (MP) a calf will receive according to the modified plan.

8.5.3 Changing the default milk ratio plan

You use the milk ratio plan to define the following:

- The milk ratio of the feed.
- The amount of milk feed received by calves in a group.
- The amount of the time calves in a group receive milk feed.

Note: A milk ratio plan with one period (**P1**) (**100% milk feed**) is the default setting. You can divide the milk ration plan into a maximum of 5 periods (**P1** to **P5**).

You can set the following milk ratios:

- 0% milk ratio, meaning only milk substitute (MP).
- 30 to 70% milk ratio, meaning milk and milk substitute (MP).
- 100% milk ratio, meaning milk only.

In **P1 (Days)** enter the total number of days (**Duration**) of the feeding plan in order to dispense feed with a constant milk ratio during the entire feed period. The total number of days can be found in the **Duration** menu option.

The length of the milk ratio plan periods does not have to match the length of the quantity plan periods. If the milk ratio plan is shorter than the quantity plan, at the end of the milk ratio plan a plan over date message will appear in the display of your hand terminal. The milk ratio of the last feeding portion fed is maintained until the end of the quantity plan.



NOTICE!

If you deviate from the default milk ratio plan, a calf could receive an insufficient quantity or concentration of feed.

This can lead to malnutrition, which causes impaired growth and development, increased susceptibility to illness or even the death of your calves.

- ▶ Ensure that the changes are not having any harmful effects, for example by rigorously monitoring your calves.

You change a default milk ratio plan as follows:

1. Navigate via  > **Feeding > Plans > Feeds** to the **Milk ratio** sub-menu.
2. Use   to select the desired **Group** (A, B, C or D).
The default milk ratio plan of this group will be shown in the display.
3. In the **Days (P1)** column, you specify how long you want the periods for the milk ratio to last.
4. In the **from (P1)** column, you enter the starting value for the milk ratio.
5. In the **to (P1)** column, you enter the final value for the milk ratio.
The cursor will jump to the next feeding period (**P2**).
6. If necessary, repeat steps 3 to 5 for **P2** to **P5**.
7. In the **Duration** menu, you can check the total duration of the milk ratio plan.
8. In the **Quantity** menu, you can check the total quantity of fresh milk in liters that a calf will receive according to this plan.

8.5.4 Changing the default quantity limitation plan

In the quantity limitation plan, you use entitlement intervals to define the number of meals (amount consumed) a calf receives per day.

Note: You can increase or reduce the feed amount in increments of 0.1 liter. Depending on the feed entitlement, the feed is distributed across one or more portions. These portions can vary in size.

To prevent overeating, the amount consumed is limited by the maximum quantity defined in the feeding plan. This means that the calves receive no more than the maximum feeding quantity at each meal.





NOTICE!

If you deviate from the default quantity limitation plan, a calf may not receive sufficient feed. You may not reduce the defined quantity limitation values any further, especially toward the end of the feeding period.

This can lead to malnutrition, which causes impaired growth and development, increased susceptibility to illness or even the death of your calves.

- ▶ Ensure that the changes will not have any harmful effects, for example by rigorously monitoring your calves.

You change a default quantity limitation plan as follows:

1. Navigate via  > **Feeding** > **Plans** > **Feeds** to the **Limitation** sub-menu.
2. Use  , to select the desired group (A, B, C or D).
The default quantity limitation plan for this group will be shown in the display.
3. In the **Days (P1)** column, you enter the duration of the change. You can enter values between 1 and 99 days. The default setting is 14 days.
4. In the **Min (P1)** column, you enter the minimum saved amount in liters. You can enter values between 0.2 and 9.5 liters. The default setting is 2 liters.
5. In the **Max (P1)** column, you enter the maximum amount in liters. You can enter values between 2.5 and 9.5 liters. The default setting is 2.5 liters.
The cursor will jump to the next feeding period (**P2**).
6. Repeat steps 3 to 5 for **P2** to **P5**.
7. In the **Block 40FIT** line, you enter the amount of time that a calf in the 40FIT period is blocked after consuming its maximum quantity. You can enter values between 00:30 hours and 02:30 hours. The default setting is 02:00 hours.
8. In the **Duration** line, you can check the total duration of the quantity limitation plan in days.
9. In the **Start time** line, you enter the time from which the saving of the feed quantity should begin. The time is calculated from 00:00. By choosing   you can set a deviation of +2 or - 2 hours.

Note: If you feed your calves according to the 40FIT principle, or if you use an electrolyte as an additive, you cannot set the start time.

8.6 Winter feeding plan



If your automatic feeder features MultiReader identification with an integrated temperature sensor, you can define a winter feeding plan for your calves. You can adjust the feed quantity or concentration so that your calves receive more feed when temperatures drop.

If the ambient temperature rises above a temperature limit that you define, the winter feeding plan is automatically disabled.

Note: The winter feeding plan can only be defined for all calves (regardless of feeding group), not for individual calves.

You set the winter feeding plan as follows:

1. Navigate via  > **Feeding** > **Plans** to the **Winter feeding plans** sub-menu.
2. In the line labeled **Check temperature?**, check whether the MultiReader identification system is equipped with a temperature sensor so that it can measure the temperature.



Note: If the message **No measurement possible** appears, you will not be able to activate the Winter feeding plan.
3. In the **active** menu option, choose   [**yes**] to activate the winter feeding plan and [**no**] to deactivate the winter feeding plan. The default setting is [**no**].
4. In the **Current temp.** menu option, you can check the current temperature at a time of 00:00.
5. In the **Ø temp. 3 days** menu option, you can check the average temperature over the last 3 days.
6. In the **Status** menu option, you can check whether an increase has been entered (**Increase on**).
7. In the **Limit temp.** menu option, you specify the minimum temperature at which you want feed to be increased.
8. In the **Increase** menu option, you specify the percentage by which you want to increase the feed quantity or feed concentration.

8.7 Alarm level

You use alarm levels to determine the time or value that triggers an alarm. Alarm levels are defined for groups. You can set alarm levels for:

- Feed consumption.
- Drinking speed.
- Feeding break.

You set alarm levels as follows:

1. Navigate via  > **Feeding** > **Alarm level** to the **Feeds** sub-menu.
2. Use   to select the desired group (A, B, C or D).
3. In the **after** menu, you enter the amount of time (hours) that can pass after a feed release before an alarm is triggered. The setting applies to the current day. The preset default value is 3 hours. You can enter values from 0 to 9 hours.
4. In the **as of** menu you enter the earliest time of day at which an alarm is triggered if the percentage entered for feed consumption is not reached. The setting applies to the current day. The default setting is 12:00 hours and 30%. You can enter times from 08:00 to 12:59 hours and values from 0 to 99%.

5. In the **yesterday** menu, you enter the minimum percentage of feed a calf must have consumed yesterday so that no alarm is triggered. The preset default value is 80%. You can enter values from 0 to 99%.
6. In the **Dr. speed** menu, you enter the percentage of drinking speed that a calf must reach so that no alarm is triggered. The preset default value is 70%. You can enter values from 0 to 99%. The average, drinking speed of a particular calf on the current day (today) is compared to its average drinking speed on the last 3 days. If the entered value is not reached, an alarm will be triggered.
7. In **break w.o.add.** , you specify how often a calf may interrupt its feed consumption (that is, drink less than its entitled quantity) before an alarm is triggered. The default setting is 3 breaks. You can enter values from 0 to 99.

9. Animal control

You can use your automatic feeder to monitor animals.

Note: You can only obtain information about calves if you run your automatic feeder with animal identification.

Choose  to go to the menus for animal control. The number next to the sub-menus shows the number of calves recorded in the relevant menu.

9.1 Animal list

In the **Animal list** menu you can list the calves in a table sorted by parameters. The table is sorted in ascending order by the first column of the first parameter. This means that the calf with the greatest need for monitoring is at the very top of the table. The following parameters can be displayed:

- Feed consumption as a percentage
- Feed consumption in liters (today or yesterday)
- Drinking speed as a percentage
- Animal visits
- Break-offs

		column 1	column 2		
1/118		cons.	dr.sp		
▶ 799	↳A2	29	56	✓	✓+
744	fA1	29	✓	✓+	✓+
715	→A1	50	91	91	91
737	↗A1	✓	56	✓+	74
742	fA1	✓	81	✓	✓+
743	→A1	✓	85	✓+	✓+
795	→D2	✓	✓	✓	✓

Note: You can also access the **animal list** directly via the key .

Here is how you define which parameters are displayed in the two columns of the animal list:

1. Navigate via  > **Device data** to the **Animal list** sub-menu.
2. In **Column 1** or **Column 2**, select by choosing   which parameter is displayed in the respective column.

You call up an animal list as follows:

1. Navigate via  to the **Animal list** sub-menu.
2. In the top line, from left to right, you can check the following:

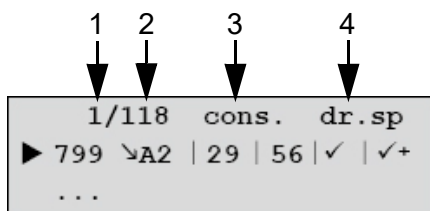

- The number of the calf you have selected in the list, counting from the top (1).
 - How many calves are registered (2).
 - The two parameters you have chosen (3 & 4).
3. You can view the following in the subsequent lines, from left to right:

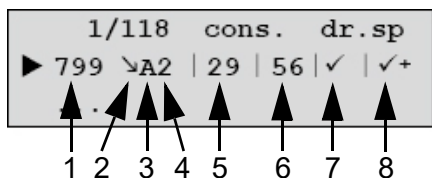

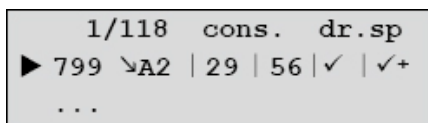

- The animal number (1).
 - The plan tendency (2).
 - The group to which the calf concerned has been assigned (3).
 - The last feeding box visited (4).
 - Parameter 1. The current value (today) is in the column on the left (5). Yesterday's value is in the column on the right (6).
- Note:** The parameter for feed consumption is simply today's value or yesterday's value in liters to two decimal places. The list can be sorted by the parameter feed consumption today in %.
- Parameter 2. The current value (today) is in the column on the left (7). Yesterday's value is in the column on the right (8).



Note: If there is a check mark instead of a number, then the value is 100%. A check mark followed by a plus indicates a value greater than 100% (only for drinking speed and visits).

For example: The calf shown with the number 799 is in the weaning phase (reduced plan tendency), has been assigned to group A and has visited feeding box 2. At present, the calf has only called up 29% of its feed entitlement, yesterday it was only 56%. The current value for drinking speed is 100% (✓); yesterday it was more than 100% (✓+).

4. Choosing  takes you to the detailed view for the animal currently highlighted. By choosing   you can scroll to the other animals.

!< 3469>A1 ↗	6.0	1
▶ cons. %:	25	100
break off:	1	0
speed. %:	85	100
visit:	3	6
C 1 %:	99	100
weight kg:	117	116
w. gain:	600	400
feed. day:	77	

Note: In each line, pressing calls up detailed information.

9.2 Entitlement

Here you can check your calves' feed entitlement.

You check feed entitlements as follows:

1. Navigate via to the **Entitlement** sub-menu.
2. From left to right in the top line, you can view the **animal number**, the **plan trend** and the **feed quantity** scheduled for the current day (today) according to the plan.
3. Use to select a calf.
4. Here you can check whether the selected calf is entitled to feed and the amount of feed to which it is still entitled.
 - **Variant 1:** The calf has a feed entitlement. In **as of**, you can check the earliest time of day at which the calf has a feed entitlement and the feed quantity saved by this time, for example **starting at 13:45 hours, 2.0 liters**.
 - **Variant 2:** The calf has no feed entitlement, for example **starting at 10:15 am, 0.0 liters or block**.
 - **Variant 3:** The calf has saved more feed that it may consume at once and it consumed less than its maximum quantity during its last visit to the feeding box. You can check the latest time of day at which the calf can consume the difference between the consumed quantity and the maximum quantity, for example **up to 11:30 am, 1.5 liters**.

Note: You can delete the feed block by pressing . Confirm **Delete block?** by choosing .
5. In the **Cons. %** menu, you can check the percentage of feed that a calf has consumed today (left column) and yesterday (right column).
6. In the **Cons. ltr** menu, you can check the number of liters that a calf has consumed today (left column) and yesterday (right column).
7. In the **Break** menu, you can see how often a calf stopped feed consumption today (left column) and yesterday (right column). A calf interrupts feeding if it has consumed less than the quantity to which it is entitled per visit.

8. In the **Visit** menu, you can see how often a calf visited the feeding box today (left column) and yesterday (right column).
 - 8.1. In the **Last** menu, you can check the time of day at which the calf last visited the feeding box.
Pressing , allows you to view the last 10 visit times with entitlement and the consumption in liters.
 - 8.2. In the **With entitlement** menu you can see how often a calf visited the feeding box today (left column) and yesterday (right column) with its feed entitlement.
 - 8.3. In the **Without entitlement** menu you can see how often a calf visited the feeding box today (left column) and yesterday (right column) without a feed entitlement.

9.3 Alarm

You define limits for parameters that are used to monitor a calf's feed intake. If a calf exceeds or falls below these limits, an alarm will be triggered. You can define limits for the following parameters:

- Feed consumption as percentage of the daily amount.
- Number of feeding breaks.
- Drinking speed.

The procedure is described in detail in chapter 8.7 "Alarm level" - 81.

You can check alarm animals as follows:

1. Navigate via to the **Alarm** sub-menu.
A table will appear in the display.
 2. From left to right in the top line, you can view the **animal number**, the **plan trend** and the **feed quantity** scheduled for the current day (today) according to the plan.
 3. Use to select a calf.
A table will appear in the display.
 4. In the **Cons. %** menu, you can check feed consumption for today (left column) and yesterday (right column). Confirm **Cons. %** by choosing .
- You can view more detailed information about feed consumption for today (left column) and yesterday (right column). You can make changes in the sub-menus (Feed ltr and Cons. g/ltr)
- 4.1. In the **Cons. %** menu you can check the percentage of feed that a calf has consumed today (left column) and yesterday (right column).
 - 4.2. In the **Cons. ltr** menu you can view feed consumption for today (left column) and yesterday (right column) in liters

Note: If you wish to set the consumed feed amount of the current day to zero, press and confirm **Delete block?** by choosing .

- 4.3. In the **Feed ltr** menu you can view and change the feed quantity to which the selected calf is entitled. The procedure is described in detail in chapter 8.4.2 "Feed quantity" - 72.
- 4.4. In the **Conc. g/ltr** menu you can view and change the feed concentration to which the calf is entitled. The procedure is described in detail in chapter 8.4.3 "Feed concentration" - 72.
- 4.5. In the **Milk %** menu you can check the milk ratio of the feed to which the calf is entitled today. This menu option will only appear if your automatic feeder is operating in MP/milk mode.
5. In the **Break** menu, you can view the number of feeding breaks for today (left column) and yesterday (right column).
 - 5.1. In the **with additive** menu, you can see how often the feed with additive has been broken off.
 - 5.2. In the **without additive** menu, you can see how often the feed without additive has been broken off.
6. In the **Drnk spd.** menu, %, you can view the drinking speed for today (left column) and yesterday (right column). Confirm **Drnk spd. %** by choosing .
 - 6.1. In the **relative %** menu, the drinking speeds for today (left value) and for yesterday (right value) are shown in percent.
 - 6.2. In the **abs.l/min** menu, the absolute drinking speeds for today and yesterday are shown.

You delete alarms as follows:

1. Navigate via to the **Alarm** sub-menu.
2. Use to select a calf.
3. Confirm **delete all?** by choosing .

Note: You can only delete alarms from **yesterday**.

9.4 Plan over date

One day before an action with a time limit ends, such as an increase in the feed quantity, you will receive a plan over date message for this action. You will receive plan date messages:

- If a calf will not receive any more feed because the feeding plan is ending (**Feed plan**).
- If the concentration plan ends before the feeding plan. Your calves will receive the most recently fed concentration until the end of the feeding plan (**Concentration plan**).
- If deviation plans (**deviation**) for feed or concentration are ending. From this point onward, the affected calves are fed according to the feeding or concentration plan of their group.

You check plan over date messages as follows:

1. Navigate via to the **Due date** sub-menu.
A table will appear in the display.

2. From left to right in the top line, you can view the **animal number**, the **plan trend** and the **feed quantity** scheduled for the current day (today) according to the plan.
3. Use to select a calf.
You will see the individual dates.

You delete due date messages as follows:

1. Navigate via to the **Due date** sub-menu.
 2. Confirm **delete all?** by choosing .
- The due date message disappears but will appear again for the next 3 days.

9.5 40FIT

In this menu, you can check how many and which of your calves are within a **40FIT period**.

1. Navigate via to the **40FIT period** sub-menu.
A table will appear in the display.
2. From left to right in the top line, you can view the **animal number**, the **plan trend** and the **feed quantity** scheduled for the current day (today) according to the plan.
3. Use to select the desired calf.
A table will appear in the display.
4. In the **Cons. %** menu, you can check feed consumption for today (left column) and yesterday (right column). Confirm **Cons. %** by choosing .



You can view more detailed information about feed consumption for today (left column) and yesterday (right column). You can make changes in the sub-menus (Feed ltr and Conc. g/ltr) A table will appear in the display.

- 4.1. In the top line, you can view the **animal number**, the **plan trend** and the **feed quantity** for the current day (today).
- 4.2. In the 2nd line, you can check the feed entitlement in liters. Depending on the feed entitlement, one of the following 3 variants will appear:





Variant 1: The calf has a feed entitlement. In **as of**, you can check the earliest time of day at which the calf has a feed entitlement and the feed quantity saved by this time, for example **starting at 13:45 hours, 2.0 liters**.

Variant 2: The calf has no feed entitlement, for example **starting at 10:15 am, 0.0 liters or block**.

Variant 3: The calf has saved more feed that it may consume at once and it consumed less than its maximum quantity during its last visit to the feeding box. You can check the latest time of day at which the calf can consume the difference between the consumed quantity and the maximum quantity, for example **up to 11:30 am, 1.5 liters**.

Note: You can delete the feed block by pressing . Confirm **Delete block?** by choosing .





- 4.3. In the **Cons. %** menu, you can view feed consumption for today (left column) and yesterday (right column) as a percentage.
 - 4.4. In the **Cons. ltr** menu you can view feed consumption for today (left column) and yesterday (right column) in liters

Note: If you wish to set the consumed feed amount of the current day to zero, press  and confirm **Delete block?** by choosing .
 - 4.5. In the **Feed ltr** menu, you can view the feed quantity in liters to which the calf is entitled today (left column) and yesterday (right column) according to the feeding plan. Here you can change the duration and quantity of deviations in the feed quantity. The procedure is described in detail in chapter 8.4.2 "Feed quantity" - 72.
 - 4.6. In the **Conc. g/ltr** menu, you can view the feed concentration to which a calf is entitled today (left column) and yesterday (right column) according to the feeding plan. Here you can change the duration and quantity of deviations in the feed concentration. The procedure is described in detail in chapter 8.4.3 "Feed concentration" .
 - 4.7. In the **Milk %** menu you can check the milk ratio of the feed to which the calf is entitled today. This menu option will only appear if your automatic feeder is operating in MP/ milk mode.
5. In the **Break** menu, you can view the number of feeding breaks for today (left column) and yesterday (right column).
 6. In the **Drnk spd. %** menu, you can view the drinking speed for today (left column) and yesterday (right column). You can view the relative (%) and the absolute drinking speed (l/min). Confirm **Drnk spd. %** by choosing .
 - 6.1. In the **Relative %** menu, you can view the relative drinking speed as a percentage for today (left column) and yesterday (right column).
 - 6.2. In the **abs. ltr/min** menu, you can view the absolute drinking speed in liters for today (left column) and yesterday (right column).
 7. In the **Visit** menu, you can view the number of visits to the feeding box for today (left column) and yesterday (right column). You can differentiate between visits with and without feed entitlement. Confirm **Visit** by choosing .
 - 7.1. In the **Last** menu, you can view the time of day at which the selected calf last visited the feeding box today (left column) and yesterday (right column).
 - 7.2. In the **With entitlement** menu you can see how often a calf visited the feeding box today (left column) and yesterday (right column) with its feed entitlement.
 - 7.3. In the **Without entitlement** menu you can see how often a calf visited the feeding box today (left column) and yesterday (right column) without a feed entitlement.
 8. In the **Feed. day** menu, you can view the feeding day the calf has reached according to the plan. You can review other detailed information in this menu. The procedure is described in detail in chapter 8.4.6 "Shortening or lengthening total feeding duration" .

9.6 Marked

In this menu, you can view an overview of the drinking behavior of a calf that you have marked. You can also mark a calf that you specifically want to monitor by choosing  (see 4.4 "Hand terminal" - 26).





You check marked animals as follows:

1. Navigate via  to the **marked** sub-menu.
A table will appear in the display.
2. From left to right in the top line, you can view the **animal number**, the **plan trend** and the **feed quantity** scheduled for the current day (today) according to the plan.
3. Use   to select the desired calf.
4. In the **Cons. %** menu, you can check feed consumption for today (left column) and yesterday (right column). Confirm **Cons. %** by choosing .
A table will appear in the display.
 - 4.1. In the top line, you can view the **animal number**, the **plan trend** and the **feed quantity** for the current day (today).
 - 4.2. In the 2nd line, you can check the feed entitlement in liters. Depending on the feed entitlement, one of the following 3 variants will appear:

Variant 1: The calf has a feed entitlement. In **as of**, you can check the earliest time of day at which the calf has a feed entitlement and the feed quantity saved by this time, for example **starting at 13:45 hours, 2.0 liters**.

Variant 2: The calf has no feed entitlement, for example **starting at 10:15 am, 0.0 liters or block**.

Variant 3: The calf has saved more feed that it may consume at once and it consumed less than its maximum quantity during its last visit to the feeding box. You can check the latest time of day at which the calf can consume the difference between the consumed quantity and the maximum quantity, for example **up to 11:30 am, 1.5 liters**.

Note: You can delete the feed block by pressing . Confirm **Delete block?** by choosing .
 - 4.3. In the **Cons. %** menu, you can view feed consumption for today (left column) and yesterday (right column) as a percentage.
 - 4.4. In the **Cons. ltr** menu you can view feed consumption for today (left column) and yesterday (right column) in liters
Note: If you wish to set the consumed feed amount of the current day to zero, press  and confirm **Delete block?** by choosing .
 - 4.5. In the **Feed ltr** menu, you can view the feed quantity in liters to which the calf is entitled today (left column) and yesterday (right column) according to the feeding plan. Here you can change the duration and quantity of deviations in the feed quantity. The procedure is described in detail in chapter 8.4.2 "Feed quantity" - 72.

- 4.6. In the **Conc. g/ltr** menu, you can view the feed concentration to which a calf is entitled today (left column) and yesterday (right column) according to the feeding plan. Here you can change the duration and quantity of deviations in the feed concentration. The procedure is described in detail in chapter 8.4.3 "Feed concentration" - 72.
- 4.7. In the **Milk %** menu you can check the milk ratio of the feed to which the calf is entitled today. This menu option will only appear if your automatic feeder is operating in MP/milk mode.
5. In the **Break** menu, you can view the number of feeding breaks for today (left column) and yesterday (right column).
6. In the **Drnk spd.** menu, %, you can view the drinking speed for today (left column) and yesterday (right column). You can view the relative (%) and the absolute drinking speed (l/min). Confirm **Drnk spd. %** by choosing .
- 6.1. In the **Relative %** menu, you can view the relative drinking speed as a percentage for today (left column) and yesterday (right column).
- 6.2. In the **abs. ltr/min** menu, you can view the absolute drinking speed in liters for today (left column) and yesterday (right column).
7. In the **Visit** menu, you can view the number of visits to the feeding box for today (left column) and yesterday (right column). You can differentiate between visits with and without feed entitlement. Confirm **Visit** by choosing .
- 7.1. In the **Last** menu, you can view the time of day at which the selected calf last visited the feeding box today (left column) and yesterday (right column).
- 7.2. In the **With entitlement** menu you can see how often a calf visited the feeding box today (left column) and yesterday (right column) with its feed entitlement.
- 7.3. In the **Without entitlement** menu you can see how often a calf visited the feeding box today (left column) and yesterday (right column) without a feed entitlement.
8. In the **Feed. day** menu, you can view the feeding day the calf has reached according to the plan. You can review other detailed information in this menu. The procedure is described in detail in chapter 8.4.6 "Shortening or lengthening total feeding duration" .

9.7 New

The **New** menu is used to monitor newly registered calves. Calves displayed under **New** are registered and can consume feed.

You change the values of newly registered calves as follows:

1. Navigate via to the **new** sub-menu.
2. In the **Animal no.** menu, you change the animal number.
3. In the **Group** menu, you register a calf in another group.
4. In the **Feed** menu, you define deviations in the dispensed feed quantity. The procedure is described in detail in chapter 8.4.2 "Feed quantity" - 72.

5. In the **Concentration** menu, you define deviations in the dispensed feed concentration. The procedure is described in detail in chapter 8.4.3 "Feed concentration" - 72.
6. In the **Milk ratio** menu, you can check the milk ratio.
7. In the **Weight** menu, you can view the initial weight.
8. In the **Plan day** menu, you can monitor the planned **feeding days**. Confirm the **Plan day** by choosing .
- 8.1. In the **Feed. day** menu, you can check the number of days that have passed since the calf was registered.
- 8.2. In the **Correct. days** sub-menu, enter a negative value such as -2 to extend the total feeding duration by 2 days. Enter a positive value such as +2 to shorten the total feeding duration by 2 days.
- 8.3. In the **Plan day** menu, you can view the plan day that the calf will be on after your correction.
- 8.4. In the **Plan end** menu, you can view the number of days in which the end of the plan will be reached.
- 8.5. In the **Feed** menu, you check the assigned feed quantity.
- 8.6. In the **Concentration** menu, you can view the feed concentration that a selected calf will receive today.
- 8.7. In the **Milk ratio** menu, you can view the milk ratio that the feed of a selected calf will contain today.
- 8.8. In the **Initial** menu, you can view the calf's initial weight.
- 8.9. In the **Date** menu, you can view the calf's arrival date.
9. In the **Time** menu, you can view the registration time of a calf.
10. In the **Date** menu, you can view the registration date of a calf.

Proceed as follows to delete a calf from the list of newly registered calves:

1. Navigate via to the **new** sub-menu.
2. Confirm **Confirm?** by choosing .



The calf will be deleted from the **New** menu.

Note: This only deletes calves from the **New** menu and not from the feed list. If you forget to confirm, the data will be automatically removed from the **New** menu after two days.

9.8 Double

During the fully automated registration process, it is possible for an animal number to be assigned twice. In the **Duplicate** menu, you can modify the duplicate animal numbers.

Proceed as follows to assign a new animal number to a calf that has been assigned a duplicate animal number:







1. Navigate via  > **Duplicate** to go to the **Animal no.** sub-menu.
The calf with the duplicate animal no. will be shown in the top line of the table.
 2. For the displayed calf, select an animal number that has not yet been assigned to a calf.
 - 2.1. Confirm the selected calf by choosing .
 - 2.2. Enter the animal number.
 3. Confirm **Confirm?** by choosing .
- The calf now has its own animal number.

9.9 Unknown

If you are running your automatic feeder with animal identification, the feeder registers all transmitters that approach it. In the **Unknown** menu, the following transmitters are registered:



- Transmitters that have not been assigned an animal number.
- Transmitters that have been assigned an animal number but that you have not yet registered for the automatic feeder and assigned to a feeding group.

Proceed as follows to check and register unknown transmitters:



1. Navigate via  to the **Unknown** sub-menu.
2. Use   to page through the list of unknown animal numbers
3. In the **No.** menu, you can view the unknown animal number.
4. In the **Number** menu, you can see how many unknown transmitters have been identified and how often.
5. In the **Time** and **Date** menus, you can see when the animal identification function last identified the unknown transmitter.
6. In the **Register** menu, you register the calf with the unknown transmitter number for the automatic feeder. Confirm **Register?** by choosing .
 - 6.1. In the **Group** menu, choose   to select a group.
 - 6.2. In the **Correct. days** menu, you enter the number of days by which you want to move the calf in the plan.
 - 6.3. Confirm **Register?** by choosing .

The calf is registered.

You delete unknown transmitters as follows:

1. Navigate via  to the **Unknown** sub-menu.
 2. Confirm **Delete?** by choosing .
- The unknown transmitter will be deleted.

9.10 All



Here you can obtain a full overview of the feeding behavior of all calves. This check works in exactly the same way as in the **marked** menu (see 9.6 "Marked" - 90) for an individual calf. Use   to scroll through the list of all registered calves.

9.11 Total consumption

In this menu, you can view the amount of feed your calves have consumed. You can display the consumption amounts of all calves, individual groups and individual calves as well as the number of quantity of portions dispensed until the present time.



9.11.1 Consumption of all calves

You display the consumption of all calves as follows:

1. Navigate via  > **Consumption** to the **Total** sub-menu.
The planned consumption amounts are displayed in the left-hand column (Set) and in the right-hand column (Actual) the actual consumption amounts of all calves for today, yesterday and the day before yesterday.
2. Use   to page through the list of displayed feed parameters.
3. In the **MP** menu you can view the amount of milk powder (MP) in kilograms that your calves have consumed today (**t.kg**), yesterday (**y.kg**) and the day before yesterday (**b.kg**).
4. In the **Milk** menu, you can view the amount of milk in liters that your calves have consumed today (**t.L**), yesterday (**y.L**) and the day before yesterday (**b.L**).

9.11.2 Consumption of individual calves

You display the consumption of individual calves as follows:

1. Navigate via  > **Consumption** to the **Animal** sub-menu.
A table is displayed that shows the feed consumption of the selected calf over the entire feeding period.
2. From left to right in the top line, you can check the **animal number**, the **plan trend** and the **feed quantity** scheduled for the current day (today) according to the plan.
3. Use   to select a calf.
4. In the **MP** menu, you can view the amount of milk powder (MP) in kilograms that the selected calf has consumed to date.
5. In the **Milk** menu, you can check the amount of milk in liters that the selected calf has consumed to date.
6. In the **Feeding day** menu, you can view the feeding day that the calf is currently on.



9.11.3 Prepared feed portions

You display the prepared feed portions of all calves as follows:

1. Navigate via  > **Consumption** to the **Portion** sub-menu.
2. In the **Number** menu, you can view all prepared feed portions to date.
3. In the **Quantity** menu, you can view the number of liters of feed prepared.

9.11.4 Consumption of a group



You display the consumption of all calves in a group as follows:

1. Navigate via  > **Consumption** to the **Group** sub-menu.
The left-hand column (**today**) shows the quantity of feed consumed today and the right-hand column shows the quantity consumed yesterday (**yest.**) in liters.
2. Use   to page through the list of displayed groups.
3. In the **Quantity** menu you can view the amount of feed in liters that calves in the selected group have consumed today and yesterday.

9.12 Print

Here you can print out the animal list or the alarm list. To do this, your automatic feeder must be connected to a printer.



To print:

1. Navigate via  > **Print** to the **Alarm list** or **Animal list** sub-menus.
 2. Confirm with **Print alarm list?** By choosing .
- The selected list will be printed.

9.13 Searching for animals

In the menus for animal control, you can search for specific calves, such as calves that you have marked. Marked calves are indicated by an asterisk (*) to the left of the animal number. You can also mark a calf that you specifically want to monitor by choosing  (see 4.4 "Hand terminal" - 26).

You search for a specific calf as follows:

1. Press .
- The animal control menus are displayed.
2. Go to the desired sub-menu.
 3. Search for the desired calf. You can search for a calf in two ways:
 - 3.1. Use   to scroll through the list of calves registered for the automatic feeder until you find the calf you are seeking.

- 3.2. Press  and enter the number of the calf you are seeking in the flashing field. The display will go directly to this calf.

If the animal number has not been assigned, the message **No such animal no.** will appear.

If the animal number has been assigned, but the calf has not been recorded in the selected menu, the message **Animal is not entitled** appears, for example in the Entitled menu.

Note: You can also use the search function  in all other menus, for example when you register calves.

10. Calibration

The first calibration is performed by your service technician during commissioning.

You must manually recalibrate powder and liquid feed and cleaning agents because the actual quantity will deviate from the set quantity for various reasons, such as fluctuations in water pressure.

If your automatic feeder is equipped with calibration scales, milk, water and MP are automatically calibrated every day. You need manually recalibrate only the cleaning agent and additives. You must also recalibrate after every new delivery of milk substitute.

NOTICE!

If you do not recalibrate your automatic feeder on a regular basis, your calves will receive insufficient or improperly mixed feed.

This will cause malnutrition. Malnutrition can cause impaired growth and development, increased susceptibility to illness or even the death of your calves.

Calibration involves several steps:

- The volume of the liquid components (water, milk cleaning agents and additives) is determined.
- The weight of the powder components (milk substitute, additives) is determined.





If your automatic feeder does **not** have **automatic calibration scales** you must provide the following items for the calibration:

- 1 Measuring cylinder with ml graduations (capacity about 1 liter).
- 1 scales (weighing accuracy 1 g).
- 1 vessel for collecting milk substitute.

10.1 Calibrating without calibration scales

You determine the actual value using scales and a graduated cylinder and the program will prompt you to enter this value using the number keys.

Proceed as follows to calibrate liquid components without calibration scales:

1. Navigate via  > **Calibration** to the **Components** sub-menu.
2. In the **Water** menu, you calibrate water.
 - 2.1. Confirm **Water** by choosing .
 - 2.2. **Set qty** shows the quantity of water to be dispensed by the automatic feeder.
 - 2.3. **Runtime** shows the time in which the automatic feeder should dispense the water.
 - 2.4. **Date** shows when the water was last calibrated.
 - 2.5. Tilt the drained mixer forwards and hold the measuring cylinder under the discharge.
 - 2.6. Confirm **Start?** by choosing .
 - 2.7. Confirm **Exit automatic mode?** by choosing . This message will only be displayed if your automatic feeder is still in automatic mode.

Water is dispensed.

- 2.8. Tilt the mixer so that the water flows into the graduated cylinder. Measure the collected water in milliliters.
 - 2.9. In the **Actual** menu, enter this measured quantity using the number keys.
 - 2.10. Confirm with .
 - 2.11. **Date** now shows the current date.
 - 2.12. Repeat the calibration to check your results.
3. Calibrate other **liquid components** using the same method.

Proceed as follows to calibrate powder components without calibration scales:

1. Navigate via  > **Calibration** to the **Components** sub-menu.
2. In the **MP** menu, you calibrate the milk substitute.
 - 2.1. Confirm **MP** by choosing .
 - 2.2. **Set quantity** shows the amount of milk substitute (MP) to be dispensed by the automatic feeder.
 - 2.3. **Runtime** shows the time in which the automatic feeder should dispense the MP.
 - 2.4. **Date** shows when MP was last calibrated.
 - 2.5. Tilt the empty mixer forward.
 - 2.6. Hold the container for the MP under the powder discharge.
 - 2.7. Confirm **Start?** by choosing .
 - 2.8. Confirm **Exit automatic mode?** by choosing . This message will only be displayed if your automatic feeder is still in automatic mode.

Powder will be dispensed.
 - 2.9. Place the container with the collected MP on the scales.
 - 2.10. In the **Actual** menu, enter the weighed quantity using the number keys.
 - 2.11. Confirm with .
 - 2.12. **Date** now shows the current date.
 - 2.13. Repeat the calibration to check your results.
3. Calibrate other **powder components** using the same method.

10.2 Calibrating with calibration scales

The automatic feeder determines the actual value using the built-in automatic calibration scales (additional equipment).

Proceed as follows to calibrate liquid components using the calibration scales:

1. Navigate via  > **Calibration** to the **Components** sub-menu.
2. In the **Water** menu, you calibrate water.
 - 2.1. Confirm **Water** by choosing .
 - 2.2. **Set qty** shows the quantity of water to be dispensed by the automatic feeder.

- 2.3. **Runtime** shows the time in which the automatic feeder should dispense the water.
- 2.4. **Date** shows when the water was last calibrated.
- 2.5. Confirm **Start?** by choosing . The calibration procedure will start. The set value of 250 ml will be shown first in the display.
- 2.6. Confirm **Exit automatic mode?** by choosing . This message will only be displayed if your automatic feeder is still in automatic mode.

The device now performs two check weighings without the user having to do anything and shows the result.

- 2.7. Then the average value of these two control weighings is shown flashing in the displayed line. Confirm with . You then return to the calibration menu.
 - 2.8. **Date** now shows the current date.
 - 2.9. Repeat the calibration to check your results.
3. Calibrate other **liquid components** using the same method.

Proceed as follows to calibrate powder components using the calibration scales:

1. Navigate via  > **Calibration** to the **Components** sub-menu.
2. In the **MP** menu, you calibrate the milk substitute.
 - 2.1. Confirm **MP** by choosing .
 - 2.2. **Set quantity** shows the amount of milk substitute (MP) to be dispensed by the automatic feeder.
 - 2.3. **Runtime** shows the time in which the automatic feeder should dispense the MP.
 - 2.4. **Date** shows when MP was last calibrated.
 - 2.5. Confirm **Start?** by choosing .
 - 2.6. Confirm **Exit automatic mode?** by choosing . This message will only be displayed if your automatic feeder is still in automatic mode.
 - 2.7. Place the calibration box into the mixer beaker and confirm the prompt **Calibration box used?** by choosing .

MP will be dispensed into the calibration beaker.

The device now performs two check weighings without the user having to do anything and shows the result.

- 2.8. Then the average value of these two control weighings is shown flashing in the displayed line. Confirm with . You then return to the calibration menu.
- 2.9. **Date** now shows the current date.
- 2.10. Remove the calibration beaker from the mixer beaker.
- 2.11. Repeat the calibration to check your results.

Proceed as follows to calibrate the cleaning agent using the calibration scales:

1. Navigate via  > **Calibration** to the **Components** sub-menu.
2. In the **Flushing agent** menu, you calibrate the cleaning agent.
 - 2.1. Confirm **Flushing agent** by choosing .

- 2.2. **Set qty** shows the quantity of cleaning agent to be dispensed by the automatic feeder.
- 2.3. **Runtime** shows the time in which the automatic feeder should dispense the cleaning agent.
- 2.4. **Date** shows when the cleaning agent was last calibrated.
- 2.5. Confirm **Start?** by choosing .
- 2.6. Confirm **Exit automatic mode?** by choosing . This message will only be displayed if your automatic feeder is still in automatic mode.
- 2.7. Place the calibration box into the mixer beaker and confirm the prompt **Calibration box used?** by choosing .

Cleaning agent will be dispensed into the calibration beaker.

- 2.8. The device now performs two check weighings without the user having to do anything and shows the result.
 - 2.9. Then the average value of these two control weighings is shown flashing in the **displayed line**. Confirm with . You then return to the calibration menu.
 - 2.10. **Date** now shows the current date.
 - 2.11. Remove the calibration beaker from the mixer beaker.
 - 2.12. Repeat the calibration to check your results.
3. If the automatic feeder is equipped with a second cleaning agent pump, also calibrate the **Flushing agent 2**.

 **WARNING!**

Risk of injury and death!

Never mix alkaline and acidic cleaning agents, since this may cause a dangerous chemical reaction. Dangerous gases may be produced and cause serious breathing difficulties. They may also cause explosions.

- ▶ Empty the calibration beaker and rinse it out with clean water before using it to calibrate the second cleaning agent.
-

11. Care and maintenance

This chapter covers regular maintenance and functional testing of the automatic feeder, and to a certain extent, its accessories. These ensure that the required hygienic standards are maintained. Maintenance includes additional measures to preserve hygiene that are not described in the cleaning chapter, as well as scheduled replacement of wearing parts. Visual and functional testing of components as well as replacement of the suction hose and teat can be carried out by the owner/operator.

Note: Repair work and the replacement of wearing parts on or in the automatic feeder, with the exception of the suction hoses and teats, may only be carried out by a service technician.

On a regular basis, you must visually inspect and test the functions of the automatic feeder and its components, clean it to maintain hygiene, calibrate it and replace simple wearing parts such as the suction hose. Depending on the automatic feeder component in question, and depending how you run your automatic feeder, you must perform inspections and maintenance on a weekly, quarterly and annual basis.

At different intervals, service messages such as RS1 (regular service 1) will appear on the display of your automatic feeder. Contact your dealer and specify the service message you have received so that the dealer can perform the necessary maintenance.

Compliance with these maintenance intervals is the only way to ensure the long life and reliability of your automatic feeder.

The following regular services (RS) have been defined:

- RS1 must be performed every 4 months.
- RS2 must be performed every 12 months.
- RS3 must be performed every 36 months.

Note: For a quicker overview, see the care and maintenance schedule in the appendix (see 14.5.2 "Maintenance intervals and activities" - 126).

11.1 Safety instructions

DANGER!

Fatal electric shock.

The electrical components of the automatic feeder are live.

- ▶ Always switch off the automatic feeder firstly with the Control switch and then disconnect the power plug before working on components of the feeder.
-



WARNING!

There is a risk of injury due to automatic start-up.

The mixer or powder mixing unit can start up automatically at any time, crushing or cutting off your hand and fingers.

- ▶ Do not reach into the hazardous area of the mixer and the powder mixing unit. Before reaching into the hazardous area of the mixer or powder mixing unit, always switch off the automatic feeder using the main switch and disconnect the power plug.

11.2 Daily care and maintenance tasks

Perform the following checks on a daily basis:

- Check the safety devices of the automatic feeder for visible damage. Are the warning signs still legible? Immediately replace any warning signs that are difficult to read or damaged. New warning signs are available from Förster-Technik GmbH.
- Check the automatic feeder and its power and water lines for visible damage. You may not run the automatic feeder if power or water lines are damaged. If it is damaged, always switch off the automatic feeder and disconnect the mains plug. Contact your service technician immediately. All repairs must always be performed by a service technician.
- Check the intensive mixer for visible damage.
 - Are the electrodes, temperature sensors and mixer blades damaged? Damaged parts must be immediately replaced by a service technician.
 - Are the mixer blades working? Damaged parts must be immediately replaced by a service technician.
 - Is the mixer housing leaking? A leaky housing must be immediately replaced by a service technician.
 - Is the mixer screen clogged? A clogged screen must be immediately cleaned by a service technician.
- Check the milk connection of the automatic feeder and the hose leading from the milk tank to the automatic feeder for leaks and wear. Leaky hoses draw in air, and this impairs the functioning of the automatic feeder. As a result, your calves could receive insufficiently concentrated feed and would not be supplied with any or sufficient feed. This can lead to malnutrition, which can cause impaired growth and development, increased susceptibility to illness or even the death of your calves. New hoses are available from your dealer.
- Check the teats and suction hoses for the following:
 - **Leaks, damage and wear.** Immediately replace damaged or leaky teats and hoses. Leaky hoses draw in air, and this impairs the functioning of the automatic feeder. As a result, your calves could receive insufficiently concentrated feed and would not be supplied with any or sufficient feed. This can lead to malnutrition, which can cause impaired growth and development, increased susceptibility to illness or even the death of your calves. You can obtain new hoses and teats from your dealer.
 - **Cleanliness.** Clean dirty hoses as described in chapter 6.1 "Cleaning with cleaning agents" - 37.



WARNING!

There is a risk of injury due to automatic start-up

The mixer and powder discharge opening can start up automatically at any time, crushing or cutting off your hand and fingers.

- ▶ Do not reach into the hazardous area of the mixer and the powder discharge opening. Switch off the automatic feeder and disconnect the mains plug. Only use the supplied scraper to clean the powder discharge opening.

-
- Check the powder discharge opening and the powder mixer unit for the following:
 - **Damage.** Damaged parts must be immediately replaced by a service technician.
 - **Foreign bodies.** Remove them using only the scraper supplied. Foreign bodies can damage the mixer, the heat exchanger and the automatic feeder. Foreign objects that enter the feed can injure your calves (see 6.2.4 "Cleaning the powder discharge opening").
 - **Milk powder deposits.** Remove them using only the scraper supplied (see 6.2.4 "Cleaning the powder discharge opening"). Milk deposits can cause the milk powder to be incorrectly dispensed. As a result, your calves could receive insufficiently concentrated feed and would not be supplied with any or sufficient feed. This can lead to malnutrition, which can cause impaired growth and development, increased susceptibility to illness or even the death of your calves.
 - Check the cleaning agent dispensing pump and if necessary the cleaning agent lance for visible damage.
 - Are the hoses on the pressure and suction side leak-tight? Have damaged hoses immediately replaced by a service technician.
 - Is the cleaning agent lance damaged, clogged, encrusted or worn? Clean the cleaning agent lance and have damaged parts immediately replaced by a service technician.
 - Is the sieve at the base of the cleaning agent lance clogged? Clean the cleaning agent lance.
 - Are all the parts present in the respective cleaning agent container? Replace it if necessary.
 - Are all the elements (cover of the cleaning agent container, hose connection of the cleaning agent lance, hose connections to the pump) correctly secured? Tighten up the connections if required.
 - Check the level in the cleaning agent container and top it up with cleaning agent if necessary.

11.3 Weekly care and maintenance tasks

- Check the effectiveness of your cleaning cycles by performing a weekly sponge cleaning of the heat exchanger (see 6.1.2.3 "Cleaning the heat exchanger" - 42).
- If a  milk sieve is present, open the sieve and clean it.

11.4 Care and maintenance tasks required every 4 months

11.4.1 Calibrating feed components

To ensure that your automatic feeder can mix the individual liquid and powder feed components water, milk and milk substitute (MP) in the proper ratio, it must be recalibrated no later than every 4 months or after each new delivery of milk substitute.

If you have not concluded a maintenance agreement for this service, you must recalibrate the feeder yourself. This is the only way to ensure that your calves receive a sufficient amount of properly mixed feed.

Proceed as described in chapter 10. "Calibration" - 97.

11.4.2 Replacing hoses and teats

- Replace all hoses that carry feed from the mixer to the feeding stations. This reduces the risk of infection. New hoses are available from your dealer.
- Replace all teats. This reduces the risk of infection. New teats are available from your dealer.
- Have the milk suction hose which runs from the milk tank to the automatic feeder replaced by a service technician. This reduces the risk of infection.

11.5 Annual care and maintenance tasks

- Perform a visual functional check of the powder mixer unit. The powder mixer unit may only be repaired by your service technician.
- Perform thorough cleaning of the powder container and dosing unit (see 6.2.4 "Cleaning the powder discharge opening" - 54).
- Have the shutoff valve cleaned by a service technician, and the associated diaphragms replaced.
- Have the pump hose for the cleaning agent pump replaced by a service technician.

12. Faults and warnings

If an error occurs while the automatic feeder is running, the Auto LED on the hand terminal will flash. The error is described in fault or warning messages displayed on your automatic feeder.

You must immediately rectify errors that occur during operation. Unresolved errors, for example during preparation of feed, could cause your calves to suffer from malnutrition.

NOTICE!

An interruption in feeding operation means that your calves will not receive any feed.

Malnutrition can cause impaired growth and development, increased susceptibility to illness or even the death of your calves.

- ▶ You must use an alternative method to supply your calves with feed as long as the automatic feeder is out of service.

You can fix some of the faults yourself. Faults that only a service technician can eliminate are indicated as such.

If a problem occurs you can allow your service technician direct access to the automatic feeder by means of remote maintenance.

For this, navigate via  > **Diagnostics** to the menu option **Remote maintenance**. A pre-requirement is that the cloud is activated and the connection between the automatic feeder and the cloud is present. Enter the ID of your service technician. This allows the service technician to make changes to the automatic feeder. The ID expires at 23:59:59 hours.

12.1 Faults

In the event of a **failure**, automatic mode is interrupted and no feed is prepared. Respond immediately to the failure and ensure that your calves are supplied with feed using an alternative method as long as the automatic feeder is out of service.

NOTICE!

An interruption in feeding operation means that your calves will not receive any feed.

This can lead to malnutrition. Malnutrition can cause impaired growth and development, increased susceptibility to illness or even the death of your calves.

- ▶ You must use an alternative method to supply your calves with feed as long as the automatic feeder is out of service.

12.1.1 Heating up

If the temperature of the boiler water is too low, **Fault heating up xx.x °C** will appear in the display. Feeder operation will be interrupted.

NOTICE!

An interruption in feeding operation means that your calves will not receive any feed.

This can lead to malnutrition. Malnutrition can cause impaired growth and development, increased susceptibility to illness or even the death of your calves.

- ▶ You must use an alternative method to supply your calves with feed as long as the automatic feeder is out of service.

You can correct the fault as follows:

1. Check whether your calves are consuming feed so quickly that the boiler does not have enough time to heat up the water.
2. Check the temperature of the portion and reduce it if necessary via  > **Device data** > **Portion**.

If the fault appears again, you must contact a service technician immediately.

12.1.2 Temperature too high

If the water temperature in the boiler is too high, **Fault, temperature too high** will appear in the display. Feeder operation will be interrupted until the water in the boiler has cooled to the set maximum temperature. Provide your calves with feed using an alternative method as long as feed operation is interrupted.



NOTICE!

An interruption in feeding operation means that your calves will not receive any feed.

This can lead to malnutrition. Malnutrition can cause impaired growth and development, increased susceptibility to illness or even the death of your calves.

- ▶ You must use an alternative method to supply your calves with feed as long as the automatic feeder is out of service.

You can correct the fault as follows:

1. Confirm **Fault, temperature too high** by choosing .
2. In **Boiler water start?**, press and keep depressed .
3. Release water from the heat exchanger's boiler into the mixer beaker until the fault message in the display disappears.
4. Confirm **Mixer: empty?** by choosing .

Check the temperature of the water supply if the heat exchanger is supplied with preheated water.

If the fault appears again:

- Check the temperature of the inflowing water and reduce it, if necessary.

This applies particularly if the heat exchanger is supplied with pre-heated water.

- If this fault persists, you must contact your service technician immediately.

12.1.3 Heat exchanger not filled

When you turn on the automatic feeder, the control unit checks whether the boiler of the heat exchanger is filled with water. If it is not filled, feeder operation will be interrupted and the message **Fault, HE not filled** will appear in the display.

NOTICE!

An interruption in feeding operation means that your calves will not receive any feed.

This can lead to malnutrition. Malnutrition can cause impaired growth and development, increased susceptibility to illness or even the death of your calves.

- ▶ You must use an alternative method to supply your calves with feed as long as the automatic feeder is out of service.

You can correct the fault as follows:

1. Confirm **Fault, HE not filled** by choosing .
2. Check the water supply.
3. In the **Fill HE?** menu, press .
4. Check that the water jet hits the rod electrode.
5. Check that the shutoff valves and the drain valve are leak-tight.

Note: If liquid flows into the mixer through these valves, the rod electrode cannot be grounded.

If this fault persists, you must contact your service technician immediately.

12.1.4 Shortage of water

If the rod electrode or the supply electrode is not grounded in the mixer beaker when water is being added and the water meter sends no pulse, a water test will be started. If the water test is not successful, then feed preparation and animal identification will be switched off. **Fault, water shortage** appears in the display.

NOTICE!

An interruption in feeding operation means that your calves will not receive any feed.

This can lead to malnutrition. Malnutrition can cause impaired growth and development, increased susceptibility to illness or even the death of your calves.

- ▶ You must use an alternative method to supply your calves with feed as long as the automatic feeder is out of service.
-

You can correct the fault as follows:

1. Confirm **Fault, water shortage** by choosing .
 2. Confirm **Boiler water start?** by choosing .
 3. Check that the water jet hits the rod electrode.
 4. Check the water supply to the automatic feeder.
 5. Check whether deposits such as calcium have formed on the electrode.
 6. Confirm **Delete fault?** by choosing when you have fixed the fault.
- If this fault persists, you must contact your service technician immediately.

12.1.5 Emptying the mixer

If the rinsing water in the mixer cannot be emptied the message **Fault, emptying the mixer** will appear. Feeder operation will be interrupted.

NOTICE!

An interruption in feeding operation means that your calves will not receive any feed.

This can lead to malnutrition. Malnutrition can cause impaired growth and development, increased susceptibility to illness or even the death of your calves.

- ▶ You must use an alternative method to supply your calves with feed as long as the automatic feeder is out of service.

**DANGER!****Fatal electric shock.**

The electrical components of the automatic feeder are live.

- ▶ Always switch off the automatic feeder using the control switch and disconnect the power plug before you perform work on the feeder's components.

You can correct the fault as follows:

1. Switch the automatic feeder off using the control switch and disconnect the power plug.
2. Check all components carrying feed from the mixer to the mixer drain valve or from the mixer up to the teat for blockages and remove them.

NOTICE!

The hose from the mixer drain valve to the drain channel may not be lengthened.

3. Insert the power plug again and switch the automatic feeder on using the control switch.
4. Confirm **Fault, emptying the mixer** by choosing .
5. Check the feeding pump:

- 5.1. Confirm **Feeding pump: start?** by choosing .
6. Check the mixer drain valve:
 - 6.1. Confirm **Mixer drain: open?** by choosing .
7. Check the rod electrode:
 - 7.1. Confirm **Bo. water start?** by choosing , to fill the mixer with water. The display must show **covered** when the rod electrode is covered with water.
 - 7.2. Confirm in **Mixer: empty?**, by choosing .
8. Confirm **Delete fault?** by choosing when you have fixed the fault.
9. Remove cleaning agent remnants from components carrying feed by rinsing them with water.

NOTICE!

Cleaning agent remnants that enter the feed can be hazardous to the health of calves.

- ▶ Remove cleaning agent remnants before recommissioning the automatic feeder.

10. Return to automatic mode.

12.1.6 Heating system

If **Failure, heating** appears in your display, contact a service technician immediately. Feeder operation will be interrupted.

NOTICE!

An interruption in feeding operation means that your calves will not receive any feed.

This can lead to malnutrition. Malnutrition can cause impaired growth and development, increased susceptibility to illness or even the death of your calves.

- ▶ You must use an alternative method to supply your calves with feed as long as the automatic feeder is out of service.

12.1.7 Boiler temperature sensor

If **Failure, boiler temperature sensor** appears in your display, contact a service technician immediately. Feeder operation will be interrupted.

NOTICE!

An interruption in feeding operation means that your calves will not receive any feed.

This can lead to malnutrition. Malnutrition can cause impaired growth and development, increased susceptibility to illness or even the death of your calves.

- ▶ You must use an alternative method to supply your calves with feed as long as the automatic feeder is out of service.

12.1.8 Milk valve/circulation valve

If the **Fault, milk valve/circulation valve** message appears in the display you can presume that there is a leak in the milk valve or in the circulation valve.

NOTICE!

An interruption in feeding operation means that your calves will not receive any feed.

This can lead to malnutrition. Malnutrition can cause impaired growth and development, increased susceptibility to illness or even the death of your calves.

- ▶ You must use an alternative method to supply your calves with feed as long as the automatic feeder is out of service.

-
1. Visually inspect and check the function of both valves.
 2. Confirm **Fault, milk valve/circulation valve** by choosing .
 3. In **Start milk pump?** press . If liquid comes out of the milk outlet after the pump starts, then one of the valves is leaking.
 4. If necessary have the valves checked and replaced by a service technician.
 5. When the cause of the fault has been remedied, in **Delete fault?** press .

12.1.9 Calibration

If the liquid or powder feed components and the cleaning agent have not been calibrated, **Calibration fault** will appear in your display. The automatic feeder will not switch to automatic mode until you have calibrated these components. Feeder operation will be interrupted.

NOTICE!

An interruption in feeding operation means that your calves will not receive any feed.

This can lead to malnutrition. Malnutrition can cause impaired growth and development, increased susceptibility to illness or even the death of your calves.

- ▶ You must use an alternative method to supply your calves with feed as long as the automatic feeder is out of service.

You can correct the fault as follows:

1. Confirm **Fault, calibration** by choosing .
2. Calibrate all components shown in the display (see 10. "Calibration" - 97). Use or to page through the list of components.

If this fault persists after calibration, you must contact your service technician immediately.

12.1.10 Milk empty

You can correct the fault as follows:

1.  > **Device data** > **Operating modes**
If **Milk empty** > **Stop** is set in the menu, feeder operation will be interrupted when the milk tank is empty.
2. Confirm **Fault, milk empty** by choosing .
3. Top up the milk tank and press .
4. In the **Milk: suck in?** menu, press until milk comes out of the inlet without any bubbles and the supply electrode or rod electrode continuously indicates that it is covered.
5. Confirm with , to stop suction of milk.
6. When the cause of the fault has been remedied, in **Delete fault?** press .
7. Confirm **Milk topped up?** by choosing .

12.1.11 Supply electrode

If the supply electrode is permanently grounded **Fault, supply electrode** will be shown in the display.

NOTICE!

An interruption in feeding operation means that your calves will not receive any feed.

This can lead to malnutrition. Malnutrition can cause impaired growth and development, increased susceptibility to illness or even the death of your calves.

- ▶ You must use an alternative method to supply your calves with feed as long as the automatic feeder is out of service.

Check whether deposits have formed on the electrode and if so, remove them carefully.

If this problem persists, you must contact your service technician immediately.

12.1.12 Station/drain valve

If a feeding box valve or the mixer drain valve (optional) is leaking **Fault, station/drain valve** appears in the display. The automatic feeder loses water during cleaning. Feeder operation will be interrupted.

NOTICE!

An interruption in feeding operation means that your calves will not receive any feed.

This can lead to malnutrition. Malnutrition can cause impaired growth and development, increased susceptibility to illness or even the death of your calves.

- ▶ You must use an alternative method to supply your calves with feed as long as the automatic feeder is out of service.
-

You must contact a service technician immediately.

12.1.13 Uncontrolled output

You will see **Fault, uncontrolled output** appear in the display if a fault occurs whilst dispensing water, milk, milk powder and cleaning agents. Feeder operation will be interrupted.

NOTICE!

An interruption in feeding operation means that your calves will not receive any feed.

This can lead to malnutrition. Malnutrition can cause impaired growth and development, increased susceptibility to illness or even the death of your calves.

- ▶ You must use an alternative method to supply your calves with feed as long as the automatic feeder is out of service.

You can correct the fault as follows:

1. Switch the automatic feeder off using the control switch, and after a few seconds switch it on again. If this fault message appears again, you must contact your service technician immediately. Notify the technician of the messages shown in the display.

12.2 Warnings

In the case of a **warning**, automatic mode will not be interrupted and feeder operation will continue.

12.2.1 Emptying the mixer

If the mixer cannot be emptied, the message **Warning, draining the mixer** will appear. For example, this can be because the drain is clogged or the feeding pump is no longer running.

DANGER!

Fatal electric shock.

The electrical components of the automatic feeder are live.

- ▶ Always switch off the automatic feeder firstly with the Control switch and then disconnect the power plug before working on components of the feeder.

You rectify the warning as follows:

1. Check all components carrying feed from the mixer to the mixer drain valve or from the mixer up to the teat for clogs and remove them.

NOTICE!

The hose which goes from the mixer drain valve to the drain channel must not be lengthened.

-
2. Check the feeding pump.

- 2.1. Confirm **Mixer emptying warning** by choosing .
- 2.2. Confirm **Feeding pump: start?** by choosing .
The feeding pump will be actuated.
3. Check the mixer drain valve.
 - 3.1. Confirm **Mixer emptying warning** by choosing .
 - 3.2. Confirm **Mixer drain: open?** by choosing .
The mixer will be drained.
4. Check the rod electrode.
 - 4.1. Visually check the rod electrode for deposits.
5. Fill and drain the mixer.
 - 5.1. Confirm **Bo. water start?** by choosing .
The mixer will fill up with water.
 - 5.2. Confirm **Mixer: empty?** by choosing .
The mixer will be drained.

If the fault has been fixed, acknowledge the message **Delete warning?** in the display with .

If this does not correct the fault, you must contact a service technician immediately.

12.2.2 Fill up the MP container

If the automatic feeder is equipped with a powder sensor, this will output a warning if the MP in the container is lower than the sensor. If the sensor reports container empty for 10 portions in succession, **Warning, top up MP** will appear in the display.

You rectify the warning as follows:

1. Confirm the MP warning by choosing .
2. Fill the powder container with milk powder

12.2.3 Milk empty

If the milk tank is empty the **Milk empty warning** will appear in the display. Instead of milk, your calves will be fed feed with milk powder stirred into it, if via  **>Device data > Operating modes** you have set **Milk empty MP** in the menu. Otherwise, feeder operation will be interrupted.

NOTICE!

There is a risk of malnutrition if feeder operation is interrupted or if the powder container is not filled with milk powder (MP).

Malnutrition can cause impaired growth and development, increased susceptibility to illness or even the death of your calves.

- ▶ As long as the automatic feeder is out of service, you must ensure that the powder container is always filled with milk powder or you must supply your calves feed using an alternative method.

The fault is corrected as follows:

1. Refill the milk container.
2. Confirm **Warning, milk empty** by choosing .
3. In the **Milk: suck in?** menu, press until milk comes out of the inlet without any bubbles and the supply electrode or rod electrode continuously indicates that it is covered.
4. Confirm with , to stop suction of milk.
5. Confirm **delete warning?** by choosing .
6. Confirm **Milk topped up?** by choosing .

The stainless steel coil of the heat exchanger is filled again.

12.2.4 Mixer temperature sensor

If the temperature sensor in the mixer beaker is faulty or the temperature of the mixed feed in the mixer beaker drops below 0°C, the **Mixer temp. sensor warning** will appear in the display.

You must contact a service technician immediately.

12.2.5 Identification

If animal identification is not working, **Warning, identification** will appear in the display.

You must contact a service technician immediately.

12.2.6 Unknown transmitter

The **Unknown transmitter warning** appears in your display:

- If a transmitter is detected by the identification unit for which no animal number has been assigned.
- If a transmitter number has been allocated to an animal number, but has still not been registered.

You rectify the warning as follows:

1. Confirm **Unknown transmitters warning** by choosing .
2. In **No.**, check the unknown transmitter number.

3. In **Number**, you check how often the unknown transmitter number has been identified.
4. In **Time**, you check when the transmitter was last registered by the identification system.
5. Confirm **Delete?** by choosing , if you wish to delete the transmitter number.
6. Confirm **Register** by choosing , if you want to allocate the unknown transmitter number to an animal number.

12.2.7 Calibration

If the last calibration was 120 days ago or if automatic calibration failed, the **calibration warning** will appear in your display. You will see which components you have to calibrate.

You rectify the warning as follows:

1. Calibrate all components shown in the display (see 10. "Calibration" - 97).
2. Confirm **delete warning?** by choosing .

Note: If you delete the warning without calibrating, the message will appear again the next day.

12.2.8 Calibration scales

If your calibration scales are not working, the **calibration scales warning** will appear in your display.

You must contact a service technician immediately.

NOTICE!

There is a risk of malnutrition caused by incorrectly dispensed feed portions.

Malnutrition can cause impaired growth and development, increased susceptibility to illness or even the death of your calves.

- ▶ You must ensure that you provide your calves with feed using an alternative method as long as the calibration scales are not working.

12.2.9 Circulation pump

The feeder control unit checks that the circulation pump is working at the start of the day. If it is not working, **Warning, circulation pump** will appear in the display.

You must contact a service technician immediately.

12.2.10 Duplicate animal number

If the same number was assigned twice during the fully automated registration process, **Warning, Duplicate animal no.** will appear in your display.

You change the duplicate animal number as follows:

1. Confirm **Duplicate animal no. warning** with .

The **Duplicate** menu in Animal control will appear (see 9.8 "Double" - 92).

2. In **No.**, the full transmitter number of the animal appears.
3. In **Animal no.**, change the automatically assigned number.
4. In **Time** and **Date**, check when the duplicate animal number appeared.
5. Once you have changed the animal number, confirm **confirm?** by choosing .

Note: Only when you have changed the animal number will your confirmation take effect and the warning be deleted.

12.2.11 Machine capacity

When there is no more storage space available for animal numbers or transmitter numbers, the **Warning, Machine capacity** will appear.

Confirm **Machine capacity** by choosing , to obtain detailed information.

- **system limit 50 animals** means: No more free animal numbers are available.
- **Transmitter storage full** means: No more storage space available for further transmitter numbers.

You rectify the warning "system limit 50 animals" as follows:

1. Cancel one or more animals in the **Animal control** menu (see 9. "Animal control" - 83).

NOTICE!

When you cancel an animal's registration it will not receive any feed.

This can lead to malnutrition. Malnutrition can cause impaired growth and development, increased susceptibility to illness or even the death of your calves.

- You must use an alternative method to supply your calves with feed.

2. Confirm **delete warning?** by choosing .

You rectify the warning "transmitter storage full" as follows:

1. Navigate via  > **Animal management** > **Transmitters** to the **Edit** sub-menu.

2. Select the transmitter number to be deleted and confirm **Delete** by choosing .

Note: You can only delete transmitter numbers of calves that are not registered (= status: available).

3. Confirm **delete warning?** by choosing .

12.2.12 Check the ball valve

If the ball valve is for working correctly and water cannot flow away into the gully, the message **Warning, check the ball valve** will appear in the display.

This is how to check the ball valve:

1. Confirm **Warning, check the ball valve** by choosing .

2. Navigate via  > **Diagnostics > Valves** to the **Ball valve** sub-menu.
3. In the **Water flowing to the gully**, menu, press . The symbol ✓ is displayed in the line.
4. In the **Boiler water: open?** Menu, press , until the mixer is filled with water.
5. In the **Circulate water** menu, press and check that water is flowing away into the gully. If the water is flowing out of the water inlet into the mixer, the ball valve is clogged or defective. You must contact a service technician immediately.
6. In the **Water flowing to the mixer**, menu, press . The symbol ✓ is displayed in the line.
7. In the **Boiler water: open?** Menu, press , until the mixer is filled with water.
8. In the **Circulate water** menu, press and check that water is flowing via the circuit into the mixer.
If the water is flowing away via the gully, the mixer, the ball valve is clogged or defective. You must contact a service technician immediately.

12.2.13 Check SD card

The **Check SD card** warning appears in the display:

- If data is to be saved manually, but no SD card is present.
- If data is to be saved manually, but the SD card is currently write-protected.
- If data is to be saved automatically but the SD card is full.
- If data is to be saved automatically but the SD card is currently write-protected.

12.3 Other faults and messages

12.3.1 Automatic feeder

12.3.1.1 Starting program

The message **Smart Vxx.xx starting program** appears when the control program of the automatic feeder starts.

Wait until the automatic feeder is ready to operate.

12.3.1.2 Initialization of the feeder

The message **first startup Press enter to start installation** will appear in the display in the following cases:

- When the automatic feeder starts for the first time.
- If the processor card must be replaced due to a hardware defect.

Follow the instructions on the screen. The following steps can be performed in the course of the initialization:

- Restoration of the last backup (if available).
- Entry of the language for the user interface.

- Entry of the current date and time.

12.3.2 Hand terminal

12.3.2.1 CAN bus off

If a short circuit or electromagnetic discharges negatively affect the CAN cable, the message **terminal Vxx.xx CAN bus off** will appear in the display.

You must contact a service technician immediately.

12.3.2.2 CAN bus heavy

The following faults trigger the message **terminal Vxx.xx CAN bus heavy**:

- Short circuit.
- Terminating resistor not set.
- Break in the data line.
- CAN cable incorrectly attached.
- No connection for automatic feeder control unit.

You must contact a service technician immediately.

12.3.2.3 Waiting

The following faults prevent the hand terminal from initializing:

- The CAN bus address of the terminal is not the same as the one defined in setup of the of the automatic feeder.
- The feeder control unit is not active.

The message **terminal Vxx.xx waiting** appears.

You can correct the fault as follows:

1. Start search mode: Press when you switch on the feeder and keep this key depressed.
2. If this message appears again, you must contact your service technician immediately.

12.3.2.4 Searching



When the hand terminal is in search mode, the message **terminal Vxx.xx searching** will appear.

You must contact a service technician immediately.

12.3.3 Boot loader

12.3.3.1 Waiting for update

The following faults trigger the message **boot loader Vxx.xx waiting for update**:

- The automatic feeder's control program is not able to run.
Update the program using an SD card or the FTP Manager.
- The boot loader was (accidentally) activated while switching on.
If when the automatic feeder was being started the   was accidentally depressed

12.3.3.2 Flash programming

The message **boot loader Vxx.xx flash programming** will appear whilst the program is being updated.

Wait until the update has been completed.

12.3.3.3 Starting program

The message **boot loader Vxx.xx starting program** will appear when the boot loader for the automatic feeder starts.

Wait until the program has started.

12.4 Service messages

A service message appears in the automatic feeder display every 4 months. This shows which maintenance (regular service) must be done by your service technician. Compliance with these maintenance intervals is the only way to ensure the long life and reliability of your automatic feeder. Please notify your service technician when the service message appears on the display.

The following regular services (RS) have been defined:

- RS1 must be performed every 4 months.
- RS2 must be performed every 12 months.
- RS3 must be performed every 36 months.

13. Disposal

All automatic feeder components, liquids and solids must be disposed of in compliance with the applicable official regulations for proper waste recycling and disposal in your country. If you are not certain which regulations apply to you, ask your service technician and use the Internet or the yellow pages to find out which government agency is responsible for your jurisdiction. Contact the appropriate authorities and find out which regulations apply to you.

Always observe the safety data sheets supplied with some components, liquids and solids.

Before you dispose of the automatic feeder, you must shut it down.

13.1 Disposing of cleaning agent residues.

Dispose of any residual cleaning agent. See the cleaning agent manufacturer's technical data sheet for more information on the disposal of the cleaning agent.

WARNING!

Chemical burns due to the cleaning agents used.

The cleaning agent can cause chemical burns to your eyes or hands.

- ▶ Always wear safety glasses and protective gloves when using cleaning agents. Follow all the safety instructions listed in the safety data sheet for the cleaning agent and wear the specified safety equipment.

13.2 Disposing of hoses

Dispose of hoses as controlled waste or municipal waste, depending on the material. Read the disposal instructions on the packaging of the hoses, or contact your waste disposal center for instructions.

13.3 Disposing of cables

Dispose of cables as controlled waste or municipal waste, depending on the material. Read the disposal instructions on the packaging of the cables, or contact your waste disposal center for instructions.

13.4 Disposal of the hand terminal

Remove the cable that connects the hand terminal to the automatic feeder. The hand terminal contains electronic components and must therefore be disposed of as controlled waste. Ask your waste disposal company where you can dispose of electronic waste.

13.5 Disposal of the processor circuit board

The automatic feeder contains a processor circuit board. You must dispose of this component separately. Ask your waste disposal company where you can dispose of electronic waste.

13.6 Disposal of the automatic feeder

For disposal instructions, contact the appropriate authorities, such as your waste disposal company or local government agency.

See the appendix for an overview of the materials in the automatic feeder.

Dispose of the automatic feeder.

14. Appendix

14.1 Standard feeding plans

Standard Feeding Plan Group A

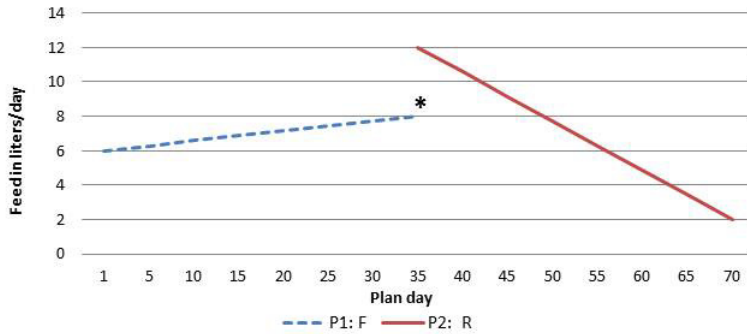

Standard Feeding Plan

P1: 35 days from 6 to 8 L **F**

P2: 35 days from 12 to 2 L **R**

Total: 70 days

Standard Concentration Plan

P1: 70 days from 150 to 150 g/L

Standard Quantity Limitation Plan

P1: 10 days: 1.5 L (Min) 2.0 L (Max)

P2: 25 days: 2.0 L (Min) 2.5 L (Max)

P3: 35 days: 2.0 L (Min) 3.0 L (Max)

F = 40FIT feeding

R = Restricted feeding

* This quantity is not intended as a maximum quantity but as a reference value to calculate an alarm level.

Standard Feeding Plan Group B

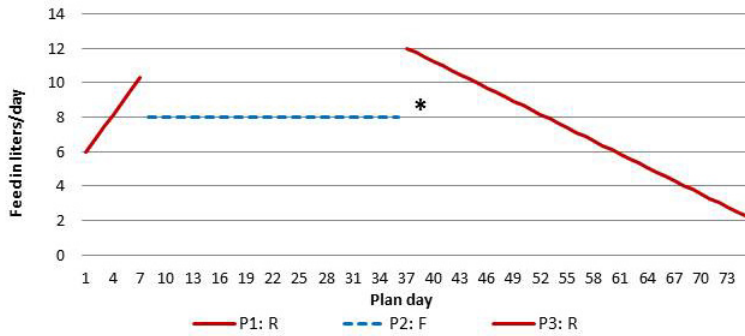

Standard Feeding Plan

P1: 7 days from 6 to 10 L **R**

P2: 28 days from 8 to 8 L **F**

P3: 40 days from 12 to 2 L **R**

Total: 75 days

Standard Concentration Plan

P1: 75 days from 150 to 150 g/L

Standard Quantity Limitation Plan

P1: 10 days: 1.5 L (Min) 2.0 L (Max)

P2: 25 days: 2.0 L (Min) 2.5 L (Max)

P3: 40 days: 2.0 L (Min) 3.0 L (Max)

F = 40FIT feeding

R = Restricted feeding

* This quantity is not intended as a maximum quantity but as a reference value to calculate an alarm level.

Standard Feeding Plan Group C



Standard Feeding Plan

P1: 2 days from 5.0 to 5.0 L
 P2: 6 days from 5.0 to 6.0 L
 P3: 21 days from 6.0 to 6.0 L
 P4: 35 days from 6.0 to 2.5 L

Total: 64 days = 316 L

Standard Concentration Plan

P1: 64 days from 150 to 150 g/L

Total: 64 days = 47.4 kg MP

Standard Quantity Limitation Plan

P1: 14 days: 1.5 L (Min) 2.0 L (Max)
 P2: 14 days: 2.0 L (Min) 2.5 L (Max)
 P3: 36 days: 2.5 L (Min) 3.0 L (Max)

Standard Feeding Plan Group D

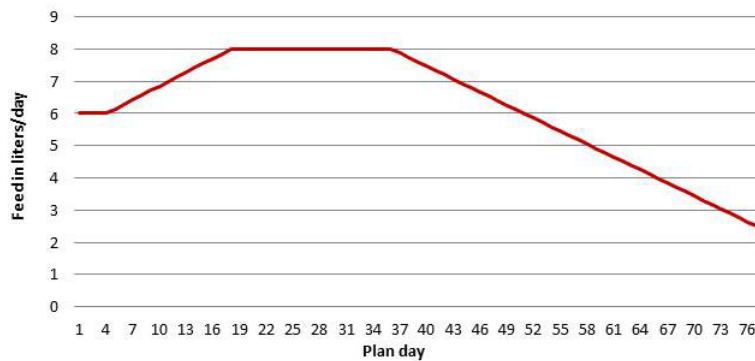

Standard Feeding Plan

P1: 3 days from 6.0 to 6.0 L
 P2: 14 days from 6.0 to 8.0 L
 P3: 18 days from 8.0 to 8.0 L
 P4: 42 days from 8.0 to 2.5 L

Total: 77 days = 478 L

Standard Concentration Plan

P1: 77 days from 150 to 150 g/L

Total: 77 days = 71.7 kg MP

Standard Quantity Limitation Plan

P1: 14 days: 1.5 L (Min) 2.0 L (Max)
 P2: 14 days: 2.0 L (Min) 2.5 L (Max)
 P3: 49 days: 2.5 L (Min) 3.0 L (Max)

14.2 Basic principle of interval feeding

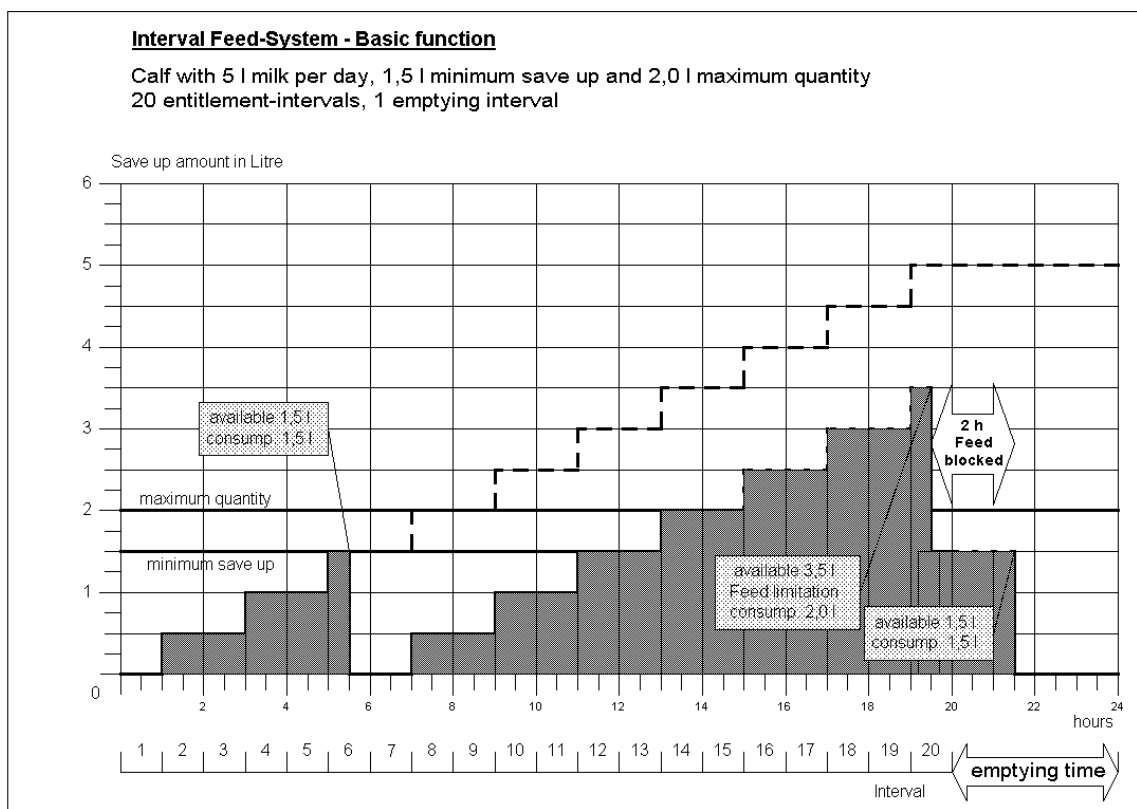

14.3 Milk powder (MP) conversion table

Required concentration (in g/ltr of feed)	Setting in concentration plan (in g/ltr of water)	Dry matter (in %/ltr of feed)
100	111	10.0
105	117	10.5
110	124	11.0
115	130	11.5
120	136	12.0
125	143	12.5
130	149	13.0
140	163	14.0
150	176	15.0
160	190	16.0
170	205	17.0
180	220	18.0
190	235	19.0
200	250	20.0

*) Guide value

14.4 Materials list

The materials used in the automatic feeder include:

- Brass, Enzidor®
- Silicon carbide
- Carbon
- V2A, V4A
- Plastics: PET, TPE, silicone, PVC, NBR, ABS, PUR
- Viton
- Vulcanized fiber, graphite-loaded
- Rubber
- Bronze
- Brass: forged & chrome-plated

14.5 Care and Maintenance schedule / routine work

Regular maintenance work and functional checks on the automatic feeder and its accessories ensure that the required hygiene standards are maintained. Maintenance includes, for example, calibration, cleaning to maintain hygiene beyond the chapter on cleaning as well as the scheduled replacement of wearing parts. Visual and functional testing of components as well as replacement of simple wearing parts, such as the intake hose, can be carried out by the owner/operator.

Note: Repair work and the replacement of wearing parts on or in the automatic feeder, with the exception of the suction hoses and teats, may only be carried out by a service technician.

14.5.1 Important safety instructions

DANGER!

Fatal electric shock

The electrical components of the automatic feeder are live. Switching the unit off using the main switch does not disconnect the voltage to the unit.

- ▶ Always switch off the automatic feeder firstly with the Control switch and then disconnect the power plug before performing any work on the automatic feeder or its components.

WARNING!

There is a risk of injury due to automatic start-up.

The automatic feeder automatically prepares a feed portion when it detects a calf entitled to feed. The stirring blades in the powder container start automatically and can crush or cut off your hand or fingers.

- ▶ Always switch off the automatic feeder with the Control switch and then disconnect the power plug before performing any work on the powder conveyor. Clean the powder discharge opening only with the scraper supplied.

⚠ WARNING!**There is a risk of injury due to automatic start-up.**

The automatic feeder automatically prepares a feed portion when it detects a calf entitled to feed. The stirring blades in the mixer start automatically and can crush or cut off your hand or fingers.

- ▶ Always switch off the automatic feeder with the Control switch and disconnect the power plug before manually cleaning the mixer.
-

⚠ WARNING!**Beware of chemical burns from the cleaning agents used.**

The cleaning agent can cause chemical burns to your eyes or hands.

- ▶ Always wear goggles and protective gloves when using cleaning agents. Follow all the safety instructions listed in the safety data sheet for the cleaning agent and wear the specified safety equipment.
-

NOTICE!**An interruption or fault in the operation of the automatic feeder means that your calves will not receive any feed.**

This can lead to malnutrition. Malnutrition can cause impaired growth and development, increased susceptibility to illness or even the death of your calves.

- ▶ You must provide your calves with feed using an alternative method if the automatic feeder is not working properly or is out of service.
-

14.5.2 Maintenance intervals and activities

Note: If you detect any faults or damage to the automatic feeder between the maintenance intervals recommended below, you must make sure they are rectified immediately by a service technician as required.

	Care/maintenance interval			
	daily	week-ly	4 months	12 months
Inspection of the calves	✓			
Automatic feeder				
• Visually inspect for damage.	✓			
Safety devices				
• Check the completeness and legibility of the safety signs (warning signs).	✓			
• Check the proper function of the scraper to clean the powder discharge opening.	✓			
• Check functioning of safety grid for powder hopper attachment.	✓			
Suction hose and teat				
• Visually check the suction hose and teat for damage and wear and clean them if necessary.	✓			
• Replace all feed hoses from the mixer to the feeding station.			✓	
• Replace the teats.			✓	
Intensive mixer				
• Visually check correct functioning of electrodes, temperature sensors and mixer blades.	✓			
• Visually inspect mixer for leaks.	✓			
• Visually check effectiveness of cleaning cycles.	✓			
• Visually inspect mixer screen for clogging and have it cleaned by a service technician, if necessary.	✓			
• Check calibration of the cleaning agent.			✓	
Cleaning agent container				
• Check whether the cleaning agent container is filled, top up if necessary.	✓			
Power and water supply				
• Visually inspect for damage.	✓			
• Calibrate the water.			✓	

Shutoff valve/feeding pump <ul style="list-style-type: none"> • Have the shutoff valve and feeding pump cleaned by a service technician and have valve membranes with support rings replaced, if necessary. 				✓
Powder mixing unit <ul style="list-style-type: none"> • Visually inspect for damage. ✓ • Check the powder discharge opening for foreign bodies and deposits. ✓ • Calibrate the MP, at least for every new MP delivery. ✓ • Empty powder container and check powder conveyor for proper functioning. ✓ • Perform basic cleaning. ✓ 			✓	✓ ✓
Checking the cleaning agent dispensing <ul style="list-style-type: none"> • Check the pressure of the hose pump and hoses, and visually inspect intake side of pump for damage and wear. ✓ • Visually check the cleaning agent lance, together with the sieve in the base, for damage, clogging, encrustations and wear. ✓ • Check that all the parts are present in the respective cleaning agent container. ✓ • Check the cleaning agent container, hose connection to the cleaning agent lance and hose connections to the pump for correct connection. ✓ • Perform calibration. ✓ • Have a service technician replace the pump hose. ✓ 			✓	✓
Milk supply and heat exchanger <ul style="list-style-type: none"> • Check milk connection and hose from the milk tank to the automatic feeder for damage and leaks and have them replaced by a service technician, if necessary. ✓ • Check effectiveness of cleaning cycles (sponge cleaning). ✓ • Carry out milk and water calibration. ✓ 		✓	✓	
Milk container <ul style="list-style-type: none"> • Have the milk suction hose, from the milk tank to the automatic feeder, replaced by a service technician. ✓ 			✓	

Index**A**

Ad lib mode 34
Alarm 30
Angle brackets 29
Animal control 31
Animal list 28 83
Arrows 29
Auto LED 25
Automatic heat exchanger cleaning 42 48
Automatic mixer cleaning 40 46
Automatic mode 25

B

Basic principle of the interval feeding program 124
Boiler 13

C

CalfCloud 35
Calibrating with calibration scales
 Cleaning agents 99
 liquid components 98
 powder components 99
Calibrating without calibration scales
 liquid components 97
 powder components 98
Calibration 97
Cancel 64
 Canceling a group 65
 Group 65
 Individual animal 64
 Weaned animals 65
Canceling animals 64
Care and maintenance work 101
Change registration 65 65
Changing the registration of animals 65
Clean the cleaning agent pump and the cleaning agent lance 50
Cleaning 37
 Basic settings 39 45
 Cleaning agent 38 39 40 42 46 48 51 120
 Cleaning agents 126
 Cleaning cycle 43 49
 Cleaning the heat exchanger 42 47

Cleaning the heat exchanger manually 43 48
Cleaning the mixer 40 46
Cleaning with a sponge 53
Filling the powder container 55
Powder discharge opening 54
Preparation 38

Cleaning cycle 44 49
Cleaning the mixer manually 41
Cleaning the powder container 56 57
Cleaning the powder discharge opening 55
Cleaning with a sponge 53
Cloud 30
Contact data 14
Conversion table for MP 124

D

Data backup 28
Deleting the transmitter number 61
Diagnostics
 Material list 125
Dimensions 12
Disposal
 Automatic feeder 121
 Cable 120
 Cleaning agents 120
 Hand terminal 120
 Hoses 120
 Processor circuit board 120

E

Electrical connection 11
Extra portion 32

F

Faults
 Boiler temperature sensor 109
 Calibration 110
 Emptying the mixer 108
 HE not filled 107
 Heating 109
 Heating up 105
 Milk empty 111
 Milk valve/circulation valve 110
 Shortage of water 107
 Station/drain valve 111

- Supply electrode 111
- Temperature too high 106
- Uncontrolled output 112
- Feeding 66
 - Feed preparation 67
- Filling the milk tank 66
- Front and right side view of automatic feeder 8
- G**
- Grounding symbol 20
- H**
- Hand terminal 27
- Hazard description 19
- Hazards
 - Chemical burns 17
 - Corrosion 17
 - Excessive physical strain 17
 - Infection 17
 - Loss of stability 17
 - Poisoning 17
- Heat exchanger 13
- Heating system diagram 11
- Hygiene 24
- I**
- Initial start-up
 - Calibration 97
- Instruction notices 20
- Intended use 16
- Interval feeding program 124
- M**
- Main menu 32
- Maintenance 101
 - Annual 104
 - Daily 102
 - Every 4 months 104
 - Weekly 103
- Maintenance intervals 126
- Maintenance work 125
- Managing the transmitters 58
- Manual functions 27 32
- Manually starting mixer cleaning 41 47
- Marking 30 30
- Material damage 17
- Milk powder container 13
 - Filling 66
- MP mode 67
- MP mode and milk mode 67
- N**
- Name plate 9
- Navigation 31
- O**
- Offline mode 25
- Operating modes 34
- P**
- Plan tendency 30
- Preconditions 16
- Prohibitory signs 20
- R**
- Rationed mode 34
- Registering animals 62
- Registration
 - automatically 63 63 63
 - manual 62
- Rod electrode 30
- Routine tasks 36
- S**
- Safety devices 22
 - Protective grid for powder hopper attachment 22
 - Safety temperature limiter 22
- Safety notices 20
- Safety signs
 - Warning signs 20
- Scraper next to the milk powder outlet 23
- Sensor 58
- Service messages 119
- Sleep mode 31
- Square brackets 29
- Symbols 29
- T**
- Transmitter numbers 58
- Transmitters
 - Assigning animal numbers 59
 - Calling up the transmitter statistics 62 62
 - Changing the animal number 61
 - Changing the transmitter number 60

- Creating transmitter numbers 58
- Deleting transmitter numbers 61
- Editing transmitters or animal numbers 60
- Manually entering transmitter numbers 59
- Reading transmitter numbers 59

W

Warnings

- Calibration 115
- Calibration scales 115
- Check SD card 117
- Circulation pump 115
- Duplicate animal number 115
- Emptying the mixer 112
- Identification 114
- Machine capacity 116
- Milk empty 113
- Mixer temperature sensor 114
- Unknown transmitter 114

Water connection 12

Weight 12

EC declaration of conformity

according to the EU Machinery Directive 2006/42/EG, Annex II, 1.A

Manufacturer:

Förster-Technik GmbH,
Gerwigstr. 25
78234 Engen

Person residing within the Community authorised to compile the relevant technical documentation:

Müller Barbara
Förster-Technik GmbH,
Gerwigstr. 25
78234 Engen

Description and identification of the machinery:

Make: Automatic feeder

Type: TAK5- VS2-*, TAP5-VS2-*, VDW5-VS2-*, TAK5-CS2-*, TAP5-CS2-*, TAK5- VS1-*, TAP5-VS1-*, VDW5-VS1-*, TAK5-CS1-*, TAP5-CS1-*, VDW5-CS1-*, TAK5- VH2-*, TAP5-VH2-*, VDW5-VH2-*, TAK5-CH2-*, TAP5-CH2-*, VDW5-CH2-*, TAK1-KU2-*, TAK5-KR3-*, TAP1-ZM2-*, TAP2-ZM2-*, VDW1-WA2-*, TAP7-AH2-*

Function: Automatic preparation, heating, and dosing of liquid feeds for young animal feeding

It is expressly declared that the machinery fulfils all relevant provisions of the following EU Directives:

2006/42/EG Directive 2006/42/EG of the European Parliament and of the Council of 17 May 2006 on machinery, and amending Directive 95/16/EG (recast)

2014/30/EU Directive 2014/30/EU of the European Parliament and of the Council of 26 February 2014 on the harmonisation of the laws of the Member States relating to electromagnetic compatibility (recast)

Reference to the harmonised standards used, as referred to in Article 7(2):

EN ISO 12100:2010-11 Safety of machinery - Electrical equipment of machines - Part 1: General requirements (ISO 12100:2010)

EN 60335-1:2012/A11:2014 Household and similar electrical appliances - Safety - Part 1: General requirements IEC 60335-1:2010 (modified)

EN 61000-6-2:2005/AC:2005 Electromagnetic compatibility (EMC) - Part 6-2: Generic standards - Immunity for industrial environments

EN 61000-6-3:2007/A1:2011/AC:2012 Electromagnetic compatibility (EMC) - Part 6-3: Generic standards - Emission standard for residential, commercial and light-industrial environments

Engen, 23.06.2017



Place, date

Signature
Markus Förster
CEO