

Original Operating Manual

Automatic calf feeder
Type VARIO smart Powder
Program version 1.01 and higher

TAP5-VS1-50



Table of contents

1	Introduction	7
1.1	Automatic feeder	7
1.2	Overview of the automatic feeder	9
1.2.1	Front and right side view of automatic feeder	9
1.2.2	Left side view of the automatic feeder	10
1.2.3	Boiler with heating circuit	12
1.3	Technical data	13
1.3.1	Electrical connection	13
1.3.2	Dimensions of the automatic feeder	13
1.3.3	Weight	13
1.3.4	Water connection	13
1.3.5	Milk powder container	14
1.3.6	Number of feeding stations and animals	14
1.4	Abbreviations	15
1.5	Manufacturer's contact details	16
2	Important safety information	17
2.1	Intended use	17
2.2	Your requirements	17
2.3	Residual risk which can arise from the automatic feeder	17
2.3.1	Material damage caused by the automatic feeder	19
2.4	Your obligations when handling the automatic feeder	19
2.5	What hazard warnings are provided?	20
2.5.1	Components of a hazard description	20
2.5.2	Hazards causing death or injury	21
2.5.3	Material damage	22
2.6	Safety labels on the automatic feeder	22
2.6.1	Warning signs on the machine	23
2.7	Safety equipment on the automatic feeder	24
3	Hygiene	27
4	Operating the automatic feeder	29
4.1	The Auto LED	29
4.2	Offline mode	29
4.3	Automatic mode	30
4.4	Hand terminal	30
4.4.1	The 15-key hand terminal	31
4.4.2	Data backup	33
4.5	Menu structure	33
4.5.1	Symbols	34
4.5.2	Navigation	36
4.5.3	Menus	37
5	Running the automatic feeder	41
5.1	Operating modes	41
5.1.1	Rationed mode	41
5.1.2	Ad lib mode (emergency mode)	41
5.2	CalfCloud	42
5.3	Routine tasks	43

6	Cleaning the automatic feeder	45
6.1	Cleaning agents	46
6.2	Preparing for cleaning	46
	6.2.1 Cleaning programs that start automatically	46
	6.2.2 Cleaning programs that are started manually	46
	6.2.3 Manual cleaning	47
6.3	Cleaning the automatic feeder	47
	6.3.1 Basic settings	47
	6.3.2 Cleaning the mixer	48
	6.3.3 Cleaning cycle	51
	6.3.4 Manual suction hose cleaning	53
	6.3.5 Rinsing the hose	54
	6.3.6 Cleaning the powder discharge opening	54
	6.3.7 Thorough cleaning of the powder container with the dosing unit	55
	6.3.8 Cleaning the detergent pump with detergent lance (option)	56
7	Transmitter and animal management	59
7.1	Managing transmitters	59
	7.1.1 Basics	59
	7.1.2 Creating transmitter numbers	60
	7.1.3 Assigning animal numbers	61
	7.1.4 Editing transmitter or animal numbers	62
	7.1.5 Deleting the transmitter number when canceling an animal	63
	7.1.6 Retrieving transmitter statistics	63
7.2	Registering animals	64
	7.2.1 Registering animals manually	64
	7.2.2 Registering animals automatically	64
7.3	Canceling animals or animal groups	66
	7.3.1 Canceling an individual animal's registration	66
	7.3.2 Canceling a group registration	67
	7.3.3 Canceling the registration of weaned animals	67
7.4	Transferring animal registrations	67
8	Feeding	69
8.1	Replenishing feed	69
	8.1.1 Filling the milk powder container	69
8.2	Feed preparation	69
8.3	Feed distribution	69
8.4	Feeding	70
	8.4.1 40FIT feeding	70
	8.4.2 Interval feeding program	70
	8.4.3 Preferred feeding	71
	8.4.4 Extra portions	72
8.5	Checking and changing feeding data for individual animals	73
	8.5.1 Group membership	73
	8.5.2 Feed quantity	73
	8.5.3 Feed concentration	74
	8.5.4 Weight	74
	8.5.5 Shortening or lengthening total feeding duration	74
8.6	Feeding plans	75
	8.6.1 Changing the default quantity plan	76
	8.6.2 Changing the default concentration plan	78
	8.6.3 Changing the default quantity limitation plan	80
8.7	Winter feeding plan	81

8.8	Alarm levels	82
9	Animal control	85
9.1	Animal list	85
9.2	Entitlement	87
9.3	Alarm	89
9.4	Plan over date	90
9.5	40FIT	91
9.6	Marked	93
9.7	New	95
9.8	Double	97
9.9	Unknown	97
9.10	All	98
9.11	Total consumption	98
	9.11.1 Consumption of all calves	98
	9.11.2 Consumption of individual calves	99
	9.11.3 Prepared feed portions	99
	9.11.4 Consumption of a group	99
9.12	Print	99
9.13	Searching for animals	100
10	Care and maintenance	101
10.1	Daily care and maintenance tasks	102
10.2	Care and maintenance tasks required every 4 months	104
	10.2.1 Manually calibrating liquid and powder components	104
	10.2.2 Replacing hoses and teats	109
10.3	Annual care and maintenance tasks	109
11	Faults and warnings	111
11.1	Faults	111
	11.1.1 Heating	111
	11.1.2 Temperature too high	112
	11.1.3 Boiler not filled	113
	11.1.4 Water shortage	113
	11.1.5 Water meter	114
	11.1.6 Mixer emptying	115
	11.1.7 Heating	116
	11.1.8 Boiler temperature sensor	116
	11.1.9 Calibration	116
	11.1.10 Station/drain valve	117
	11.1.11 Uncontrolled output	117
11.2	Warnings	117
	11.2.1 Identification	117
	11.2.2 Mixer emptying	118
	11.2.3 Mixer temperature sensor	119
	11.2.4 Unknown transmitters	119
	11.2.5 Calibration	119
	11.2.6 Calibration scale	120
	11.2.7 ID chip	120
	11.2.8 Double animal number	120
	11.2.9 Machine capacity	121
	11.2.10 Check SD card	122
11.3	Other faults and messages	122
	11.3.1 Automatic feeder	122
	11.3.2 Hand terminal	122

11.3.3	Bootloader	123
11.4	Service messages	124
12	Disposal	125
12.1	Disposing of residual cleaning agent	125
12.2	Disposing of hoses	125
12.3	Disposing of cables	125
12.4	Disposing of the hand terminal	125
12.5	Processor board	126
12.6	Disposing of the automatic feeder	126
13	Appendix	127
13.1	Standard feeding plans	127
13.2	Basic principle of interval feeding	129
13.3	Milk powder (MP) conversion table	129
13.4	Automatic feeder material list	130
13.5	Care and maintenance schedule / routine work	130
13.5.1	Important safety information	131
13.5.2	Maintenance intervals and activities	131

1 Introduction

This chapter explains how your automatic feeder is designed and how to run it safely as intended.

- > Read the operating manual carefully before commissioning the automatic feeder and ask your service technician to explain anything that is unclear to you before commissioning.
- > Do not operate the automatic feeder until you have read and understood the safety chapter (see chapter 2 Important safety information, page 17). Resolve any questions with your service technician before commissioning the feeder.
- > The operating manual for the automatic feeder, the operating manuals of all additional equipment to be connected and the safety data sheets for cleaning agents must be kept readily available at all times and passed on to the next user.
- > Observe all of the warnings and safety instructions in this operating manual.
- > If your automatic feeder has additional equipment, you must also observe the separate operating manuals and the safety warnings and safety instructions for the additional equipment.

1.1 Automatic feeder

Modern calf rearing businesses primarily use feeding systems with individual animal identification functions. Calves are identified via their collar transponders or electronic earmarks and fed based on their individual requirements.

Feed is always prepared fresh and dispensed to calves in small portions at the temperature and concentration that you have specified.

The hand terminal provides quick and easy access to the controls of the automatic feeder when you are right near your animals. You can connect the automatic feeder to your PC and then control the feeder from your computer.

Your advantages:

1. Added functions eliminate cumbersome routine tasks and save you time.
2. Automatic cleaning programs improve feed hygiene.
3. The hand terminal gives you quick access to important animal data.
4. The animal control list provides a clear and easy way of monitoring animals.
5. The automatic feeder offers you a wide range of options for feeding plans and recipes.
6. You can expand the functionality of the automatic feeder by integrating concentrate feeders and PC programs with graphical analyses.
7. The automatic feeder's rugged and reliable design makes it easier to use in pens.
8. The automatic feeder can be integrated into the feeding systems of well-known dairy equipment manufacturers.

1.2 Overview of the automatic feeder

1.2.1 Front and right side view of automatic feeder

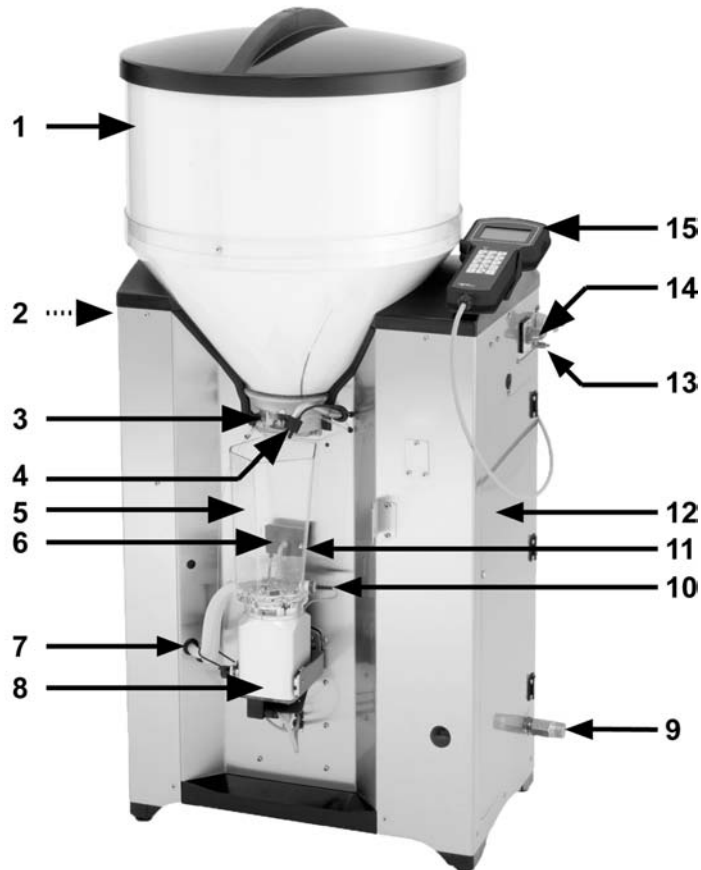

- | | |
|---|---------------------------------------|
| 1 Milk powder container | 9 Water connection |
| 2 Outlet valve (not shown here) | 10 Temperature sensor |
| 3 Milk powder discharge | 11 Point electrode for 500 ml portion |
| 4 Water supply | 12 Right door |
| 5 Mixer jar | 13 Ground connection screw |
| 6 Rod electrode | 14 Main switch |
| 7 Hose connection from mixer to station valve | 15 Hand terminal |
| 8 Mixer motor | |

1.2.2 Left side view of the automatic feeder

The name plate is located above the left side door on the outside of the automatic feeder. It contains information about the manufacturer, type and number of the automatic feeder, information about connecting the feeder to the power supply as well as its certification.

Name plate

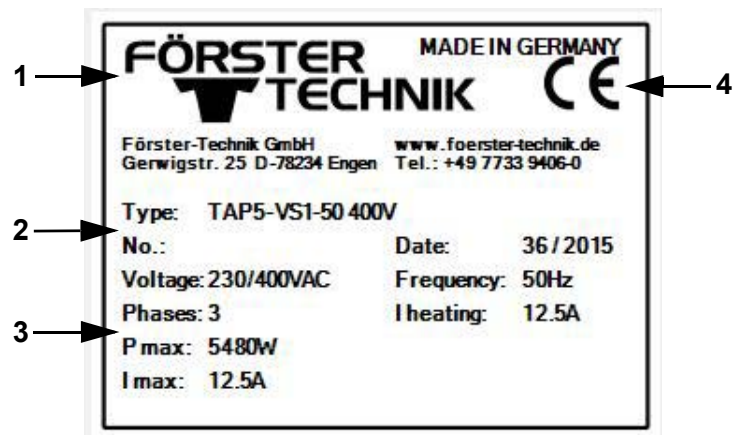

- 1 Name and address of the manufacturer
- 2 Type and number of the automatic feeder
- 3 Information on the connection to the power supply
- 4 The automatic feeder's certifications

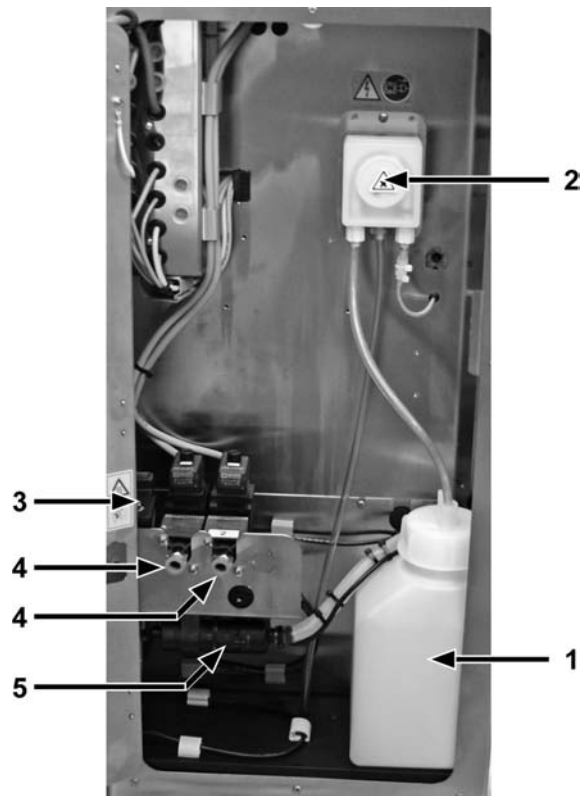
Behind the left side door

- 1 Storage container for detergent (optional)
- 2 Detergent pump (optional)
- 3 Mixer drain valve
- 4 Feeding box valve(s)
- 5 Feeding pump

1.2.3 Boiler with heating circuit

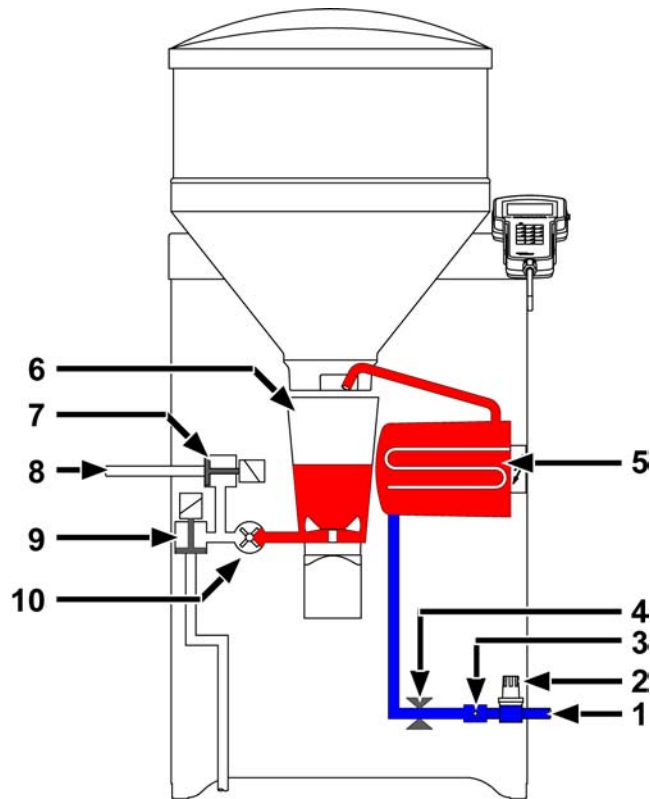

- | | | | |
|---|--------------------------------|----|--|
| 1 | Hose connection for water pipe | 6 | Mixer |
| 2 | Pressure-reducing valve | 7 | Feeding box valve |
| 3 | Water meter | 8 | Hose connection between feeding box valve and teat |
| 4 | Boiler water valve | 9 | Mixer drain valve |
| 5 | Boiler | 10 | Feeding pump |

1.3 Technical data

1.3.1 Electrical connection

Note: The specifications for the electrical connection to your automatic feeder are on its name plate above the left side door on the outside (see **1.2.2** Left side view of the automatic feeder, page 10).

1.3.2 Dimensions of the automatic feeder

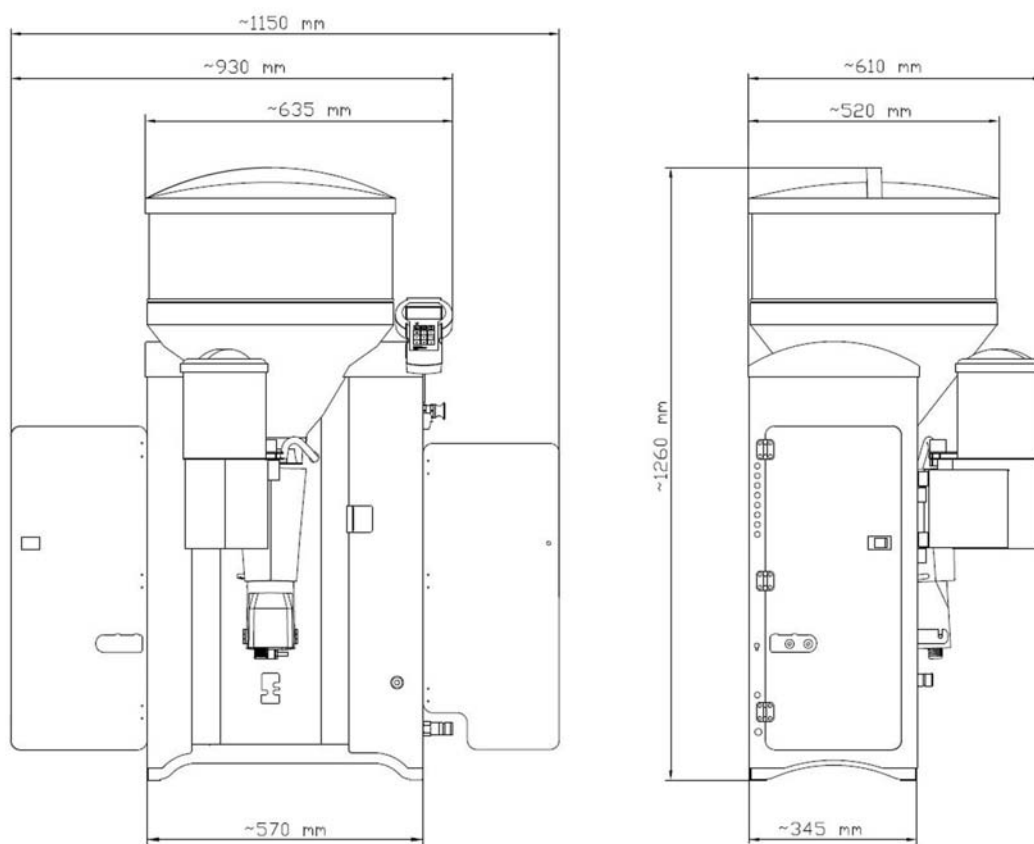

Depth when the fly screen door is opened ~ 690 mm

1.3.3 Weight

Approx. 80 kg.

1.3.4 Water connection

Water is connected via a 3/4 inch hose and with a 3/4 inch screwed connection.

ATTENTION The water should be of drinking water quality. Please bear in mind that high calcium, iron and manganese concentrations cause premature wear. In these cases it makes sense to install appropriate filtration systems.

The water pressure on site must be between 1 and 6 bar.

1.3.5 Milk powder container

The milk powder container with attachment holds approximately 35 kg of milk substitute.

1.3.6 Number of feeding stations and animals

Feeding stations	Calves per feeding station	Calves per device
Max. 4	Max. 32	Max. 128

1.4 Abbreviations

Below is a list of the abbreviations used in this operating manual.

Abbreviation	Meaning
add. disp.	Additive dispenser
abs.	Absolute
bo	Boiler
C	Concentrate
cl.mixer	Cleaning the mixer
comp. factor	Compensation factor
conc./concentr.	Concentration
dos.	Dosage
Drnk spd.	Drinking speed
Drain via teat	Drain via teat
dr. time	Drain time
El	Electrolyte
Elec.	Electrode
F / f	40FIT feeding principle
Full mixer	Mixer full
gradient	Gradient control
gr. A (B)	Group A (B)
IFS-TR / IFS-4 / -KF	Intelligent feeding station feed / quadruple compact unit / concentrate
Inc./Red.	Increase/reduction
l. service	last service
IV	Interval feeding program
MAP	Manual feeding pump
MP	Milk substitute
max	Maximum
Min. temp.	Minimum temperature
No.	Number
n. service	next service
P 1-5	Periods 1 - 5
R	rationed feeding principle
R1-4	Prescription 1 to 4
servo	Servo control
sw.off del.	Switch-off delay
sw. on del.	Switch-on delay
Temp.	Temperature
TR	Feeding box
T. slider	Teat slider
w. add.	With additive
w/o add.	Without additive
water bo.	Boiler water

1.5 Manufacturer's contact details

Please contact us if you have any questions about our products or require technical support. When you contact us, always specify the model, serial number and program version of your automatic feeder so that we can tailor our service to your unit.

The device number and model are located on the name plate on the left of the automatic feeder housing. When commissioning your automatic feeder, ask your service technician for the device number and model.

You can call up the program version via your hand terminal. The menu item for the program version can be found under  > **Diagnosis > Version > Feeder**. When commissioning your automatic feeder, ask your service technician for the version of your program.

You can note the device type, serial number and program version in the fields provided.

Device type:

Serial number:

Program version:

Our contact details:

Förster-Technik GmbH
Gerwigstrasse 25
D-78234 Engen, Germany
Tel: +49/ (0)7733/ 9406- 0
Fax: +49/ (0)7733/ 9406- 99
info@foerster-technik.de
www.foerster-technik.de

2 Important safety information

This chapter outlines:

- The hazards caused by your automatic feeder and how to avoid them.
- The safety labels attached to the automatic feeder and what they mean.
- How to operate the automatic feeder safely.

The automatic feeder is state of the art and is produced in compliance with recognized safety regulations. However, hazards and adverse effects may arise when using it. Both warning signs directly on the automatic feeder and warning notices in this manual provide warning of these hazards.

2.1 Intended use

The automatic feeder may only be used to prepare, heat, and dispense liquid feeds, for example milk, for calves.

2.2 Your requirements

You must have experience in calf rearing, many years of professional experience in agriculture and an excellent command of technical agricultural practice.

You must be familiar with accident prevention regulations and the generally recognized safety regulations.

2.3 Residual risk which can arise from the automatic feeder

Hazards to health caused by the automatic feeder:

⚠ WARNING The automatic feeder is electrically powered. You must observe the general precautions for handling electrical equipment:

- Read the operating manual before operating the automatic feeder.
- Keep children away from the automatic feeder.
- Do not touch any moving parts of the automatic feeder, for example the mixer blades.
- Only use genuine spare parts from the manufacturer.

- Turn off the automatic feeder and disconnect the power plug before carrying out any maintenance or cleaning work on the automatic feeder.
- If you are operating the automatic feeder outside of closed spaces, you must protect it against rain and moisture, for example with a roof.
- The following specific hazards are associated with the automatic feeder's electrical system:
 - **Electrical breakdown.** If there is an electrical or voltage breakdown, electric current flows through parts of the automatic feeder that are normally insulated. Touching the unit can cause a fatal electric shock. The automatic feeder must be checked regularly for electrical safety in compliance with national regulations (repeated inspection). Make sure that a 30 mA residual current device (RCD) is installed.
 - **Short circuit, indirect contact.** If there is a short circuit, current at many times the level of the operating current can flow. Touching the unit can cause a fatal electric shock. Make sure you install a fuse (provided by the customer) corresponding to the rating on the name plate and a 30 mA residual current device (RCD) in compliance with local regulations.
- The solenoid valves and the pipes to the valves can reach temperatures of up to 70°C. Touching them can cause burns. Do not touch the solenoid valves and pipes during operation.
- Liquid at temperatures of up to 70°C can spray out of the pipes to the valves. This can cause scalding. Do not touch the pipes during operation. Carry out the recommended maintenance on the hoses.
- The mixer and powder supply may start up unexpectedly if a calf which is entitled to feed approaches the unit. This can crush or chop off fingers or hands. Never reach into the area of the mixer or powder supply while the automatic feeder is in operation. Only use the scraper supplied to clean the powder discharge opening.
- **Poisoning.** Additives that are fed to the calves may contain substances that are hazardous to human health. Avoid direct contact and always wear protective gloves and goggles when handling these substances.
- **Chemical burns.** The cleaning agent used to clean the automatic feeder contains caustic substances. These can cause severe injuries to the hands or eyes. Avoid direct contact and

always wear chemical-proof protective gloves and goggles when handling the cleaning agent.

- **Excessive strain.** The automatic feeder weighs 80 kg. Never attempt to carry it by yourself as this can cause excessive physical strain.

2.3.1 Material damage caused by the automatic feeder

The automatic feeder can cause the following types of material damage:

- **Infection.** Improper cleaning or incorrect operation can result in calves becoming infected by pathogens from the automatic feeder. This can lead to medical costs or to the death of the calves.
- **Corrosion.** Improper cleaning or maintenance can result in the automatic feeder ceasing to function correctly.
- **Loss of stability.** The automatic feeder must be set up on a level surface. Otherwise, the automatic feeder can tip over and suffer damage.

2.4 Your obligations when handling the automatic feeder

- Prevent misuse by children.
- Carefully read the operating manual before starting to use your automatic feeder and ask your service engineer to explain anything that you do not understand before you use it for the first time.
- Follow the health and safety and accident prevention regulations.
- Only clean the automatic feeder with the cleaning agents recommended in this manual (see **6.1 Cleaning agents, page 46**).
- When cleaning the automatic feeder, observe the safety instructions stipulated in the safety data sheet for the cleaning agent.
- Wear the safety equipment specified in the safety data sheet for the cleaning agent, such as goggles and chemical-proof protective gloves, when cleaning the automatic feeder.
- Only operate the automatic feeder if it is in faultless condition and is fully functional.
- Only operate the automatic feeder if the safety equipment is fitted and intact.

- Regularly check the fitted safety equipment to ensure that it is working properly. You will find a care and maintenance schedule in the appendix (see **13.5.2** Maintenance intervals and activities, page **131**), which provides recommendations of how often to check the various safety devices.
- Visually inspect the automatic feeder for possible damage. You will find a care and maintenance schedule in the appendix (see chapter **13.5.2** Maintenance intervals and activities, page **131**), which provides recommendations of how often you should check different parts of the automatic feeder.
- Repair any damage to the automatic feeder, or if you are not authorized to or capable of doing this yourself, have it repaired by a service engineer.
- Never carry out any unauthorized modifications to the automatic feeder.
- Keep all safety labels on the automatic feeder in a legible condition. Replace damaged or illegible safety labels immediately. You can order new safety labels from Förster-Technik GmbH.
- Only use genuine accessories, spare parts, and wearing parts. These are available from your dealer.

2.5 What hazard warnings are provided?

Hazards are indicated directly on the automatic feeder by safety labels (warning signs, instruction and prohibition notices), and in the operating manual by specially marked hazard descriptions.

The warnings for hazards that can cause death or injury to people are emphasized more than those for material damage, for example through the colors, hazard words or symbols used.

Safety labels are an important element of the overall automatic feeder safety concept. They provide warnings about hazards and explain how to avoid them.

Make sure that all the specified safety labels are fitted to your automatic feeder and that they are in a legible condition. If the safety labels are difficult to read, replace them immediately.

New safety labels are available from Förster-Technik GmbH.



2.5.1 Components of a hazard description

A hazard description is always made up of the following elements:

- The hazard word (Danger, Warning, Caution, Attention).
- The nature of the hazard (what could happen?).
- The location of the hazard (where can it occur?).
- The actions to take to prevent the hazard (what do I need to do?).

2.5.2 Hazards causing death or injury

Depending on their severity and the probability of them occurring, hazards that can cause death or injury to people are indicated by a hazard symbol  (warning triangle with exclamation mark) and the following hazard words:

- The word **DANGER** indicates an imminent hazard that will lead to death or serious injury.
 - Warning signs on automatic feeder: **DANGER** (white text on red background).
 - Operating manual:  (white text on black background).
- The word **WARNING** indicates a potentially hazardous situation that could lead to death or serious injury.
 - Warning signs on automatic feeder: **WARNING** (black text on orange background).
 - Operating manual:  (white text on black background).
- The word **CAUTION** indicates a potentially hazardous situation that could lead to minor injury.
 - Warning signs on automatic feeder: **CAUTION** (black text on yellow background).
 - Operating manual:  (white text on black background).

The automatic feeder can cause the following hazards that can result in death or injury:

- Electrical breakdown.
- Short circuit, indirect contact.
- Electric shock.
- Spraying of liquids at high pressure.
- Burns, scalding.
- Unintentional, unexpected start-up.

- Excessive strain.
- Crushing, clipping, cutting or cutting off.
- Health hazards.
- Chemical burns.

2.5.3 Material damage

The word **Attention** indicates possible material damage. The automatic feeder or an object in its vicinity may be damaged, for example a calf.

- Prohibition notice on the automatic feeder: a pictogram crossed out in red in a white circle with a red border indicates something you are not allowed to do.
- Operating manual: **ATTENTION** (white text on black background).

The automatic feeder can cause the following material damage:

- Infection.
- Corrosion.
- Loss of stability.

2.6 Safety labels on the automatic feeder

Different safety labels are attached at the hazardous points on the automatic feeder. Warning signs, prohibition and instruction notices.

What are warning signs?

Warning signs consist of:

- A pictogram in a yellow triangle illustrating the potential hazard.

What are prohibition notices?



Prohibition notices show a pictogram of the prohibited action in a red crossed out circle. See adjacent example. They illustrate what you are not allowed to do. In the example, the crossed out hose means that you are not allowed to use high pressure cleaners.

What are instruction notices?



Instruction notices show a pictogram of what you are being instructed to do in a blue circle. They illustrate what you have to do. In the example, the pictogram means that you must always disconnect the plug first.

Other labels



Grounding label You will see this label at the points where you have to ground the equipment.

2.6.1 Warning signs on the machine

Danger of death by electric shock

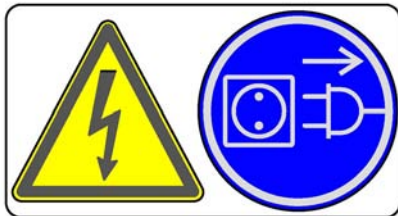

Burns / scalding



Health hazards due to additives



Chemical burns caused by cleaning agents



Automatic startup



Do not spray the equipment down



Grounding label



2.7 Safety equipment on the automatic feeder

The automatic feeder may only be operated if the safety equipment is complete and intact. The automatic feeder has the following safety equipment:

- Safety signs (warning signs, instruction and prohibition signs).
- The heater's safety temperature limiter. This shuts down the heater in the event of overheating (temperature rises above 70°C). The heater may only be reactivated by a service engineer.

- Safety grid for the powder hopper attachment. The safety grid prevents people from being injured by the rotating tools in the hopper, for example when adding milk powder. It must always be installed when the unit is operating.
- The scraper next to milk powder discharge. The powder discharge opening may only be cleaned with the scraper. This prevents finger and hand injuries caused by the powder conveyor starting up automatically.

The safety devices at the machine are an important part of the safety concept and help prevent accidents.

- Do not remove or change the safety devices without observing the corresponding safety instructions.
- Put the machine into service only after all safety devices have been attached and are in protection position.

Safety temperature limiter

The heating of the automatic feeder is equipped with a safety temperature limiter which is triggered in the event of overheating (70°C) and consequently shuts down the heating.

The safety temperature limiter is triggered if the water gets too hot or if the heater is running dry.

The heater may only be reactivated by a service engineer.

Safety grid for powder hopper attachment

The protective grid for the powder hopper attachment prevents you from being injured by the rotating tools in the powder hopper, for example, when filling in milk powder.



1 Protective grid

⚠ WARNING There is a risk of injury due to rotating tools. The safety grid must always be installed when the unit is operating.

Scraper next to milk powder discharge

The powder discharge opening may only be cleaned with the scraper. This prevents finger and hand injuries caused by the mixer starting up automatically.

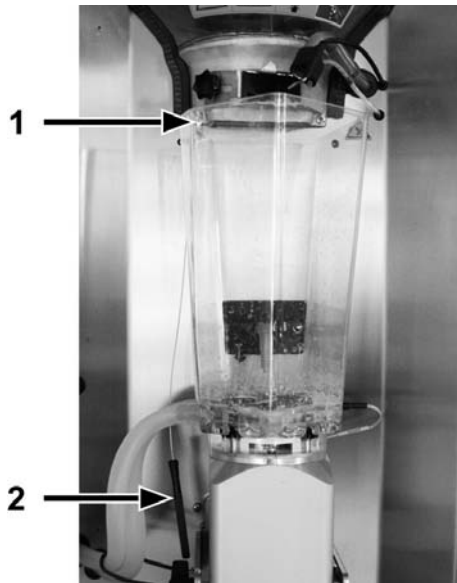

- 1 Mount for scraper
- 2 Scraper

⚠ WARNING There is a risk of injury due to automatic start-up. Do not reach into the hazardous area of the mixer. The mixer can start up automatically at any time, crushing or cutting off your fingers. Always turn off the automatic feeder with the main switch and disconnect the power plug. Only use the scraper supplied to clean the powder discharge opening.

3 Hygiene

As a farmer with experience in calf rearing, you understand how unhygienic conditions affect the health of your calves. Diarrhea and respiratory infections are frequently occurring infectious diseases in calves.

Every sick calf involves additional costs, for example for veterinarians and medication, and requires extra time for care.

The younger the calf, the weaker its immune system, and the more prone to infection it will be.

The possibility of infection can never be completely eliminated, but it can be minimized by taking measures to ensure good hygiene.

Maintaining cleanliness is one important and easy measure that helps prevent infectious diseases.

Through proper cleaning at regular intervals, every calf-rearing business can reduce the risk of infection for its calves and save money as a result.

Measures to ensure hygienic conditions save time and money.

What are infections? An infection occurs when germs invade and multiply in a host.

Germs are all around us. However, they are not dangerous until they multiply in great numbers. The risk of infection increases with the number of germs.

When germs get into your animal feed, such as milk, they can spoil the feed and make it inedible.

When germs get into your calves, for example from infected feed or other infected calves, your calves can become sick and die.

Both situations result in costs that you can minimize by taking measures to ensure hygienic conditions.

As a farmer, it is your job to identify sources of infection and bring them under control.

So how do you prevent infections? By keeping animals in good conditions, with good drinking water and feed quality and, most importantly, through cleanliness.

Proper cleaning is an important way of ensuring hygienic conditions and also prevents infections.

If the automatic feeder is not cleaned or is cleaned improperly, germs, which are abundant in the environment, can enter the nutrient-rich feed and multiply. When they drink the feed, calves can become infected, sick and even die.

Proper cleaning of the automatic feeder reduces the number of germs and therefore the risk of infection.

The cleaning (see **6** Cleaning the automatic feeder, page **45**) chapter explains how to clean the automatic feeder properly. The appendix contains a table of suggestions of how to clean the different parts of the automatic feeder (see chapter **13.5.2** Maintenance intervals and activities, page **131**).

4 Operating the automatic feeder

This chapter explains how to operate your automatic feeder using the hand terminal.

The hand terminal is directly connected to your automatic feeder by a cable. You switch it on and off together with the automatic feeder. It remains in operation as long as the automatic feeder is switched on.

Note: After the hand terminal has been switched on, the version of the hand terminal's program first briefly appears in the display, before the automatic feeder carries out a test routine. Do not press any buttons on the control panel during these initial routines.

- You monitor and control the automatic feeder (the **feeding pump**, for example) directly via the keys of the hand terminal.
- You monitor and change the settings of the automatic feeder and the values for your calves via menus. The menus and sub-menus are arranged so that you can find the necessary settings quickly and easily. With a click of a button, you can access the most important menus, such as **Animal control**, **Main menu** and **Manual functions** as well as the **Animal list**.

You can run the automatic feeder in offline mode or in automatic mode.

4.1 The Auto LED

The Auto LED (light-emitting diode) of your hand terminal displays important information about the status of the automatic feeder:

- In automatic mode, the LED lights up green.
- In offline mode, the LED is not lit up.
- In event of faults or warnings, the LED flashes.

4.2 Offline mode

In offline mode, you do things that you cannot do while the unit is in operation, such as recalibrate feed components. When the automatic feeder switches from automatic to offline mode, the Auto LED goes out.

You switch to offline mode when you open a menu that requires offline mode, such as the calibration menu.

1. In the corresponding menu, press .

2. Confirm the message **Exit automatic mode?** message by choosing .

The Auto LED on your hand terminal goes out.

3. Perform the desired action.

4.3 Automatic mode

You perform most routine tasks, such as feeding, in automatic mode. In automatic mode, the Auto LED lights up green.

You end automatic mode by pressing and by confirming the message **Exit automatic mode?** with .

After a prolonged period of inactivity, the automatic feeder automatically returns to automatic mode. This time period is defined during commissioning. The default setting is 20 minutes.

You switch from offline mode to automatic mode as follows:

1. Press until the message **Start automatic mode?** appears in your display.
2. Press .

You are now in automatic mode again. The Auto LED lights up green.

4.4 Hand terminal

The hand terminal is directly connected to the automatic feeder by a cable. The lighting of the display switches off when the unit is not used for a long period. This saves power.

4.4.1 The 15-key hand terminal

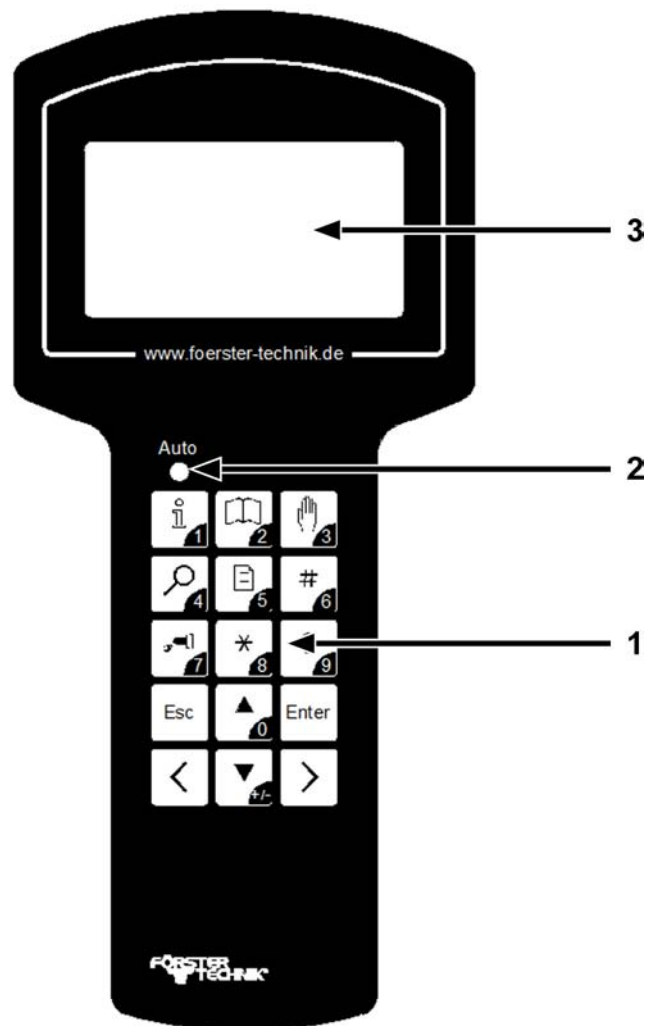

- 1 Keypad
- 2 Auto LED
- 3 Display

Keypad

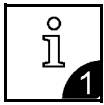

With this key, you open the **Animal control** menu or enter the number 1.



With this key, you open the **Main menu** or enter the number 2.



With this key, you open the **manual functions** menu or enter the number 3.



With this key, you open the **Search functions** or enter the number 4.



With this key, you open the **Animal list** or enter the number 5.

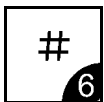

Key 6 is a freely selectable **function key**. With this key, you can also enter the number 6.



With this key, you activate the **feeding pump** or enter the number 7.

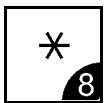

This key is assigned 2 functions:

- You press this key to select a calf in submenus in which an animal number is displayed. An asterisk (*) is displayed in front of the animal number of a selected calf. You deselect the calf by pressing this key again.
- In the overview menu in automatic mode, you use this key to toggle between the four-line (large font) and the eight-line (small font) display.

With this key, you can also enter the number 8.

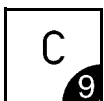

This key is assigned 2 functions depending on the menu you are currently in:

- You use this key to delete warnings and alarms.
- In the overview menu of automatic mode, you use this key to bring warnings to the foreground.

With this key, you can also enter the number 9.

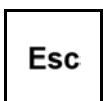

You use this key to go backward within the menu structure. You return to the starting menu by pressing this key multiple times.

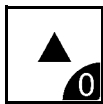

You use this button to move the cursor upward and choose items from a list, for example [yes] or [no]. With this key, you can enter the number 0.



With this key you move the cursor downward and select items from a list. You use this key to change the sign of a number, for example from +1 to -1. This is how you enter negative numbers.



You use this key to confirm your selection and open a menu or an input field. An [input field] is indicated by square brackets.

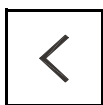

You use this key to scroll between pages on the screen or list items to the left and jump to the start of a list.

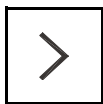



You use this key to scroll between pages on the screen to the right and jump to the end of a list.



4.4.2 Data backup

The automatic feeder performs an automatic data backup at night. You can also start the backup manually. The data of the automatic feeder can be stored on an SD card.

4.5 Menu structure

The automatic feeder is controlled using menus, submenus and lists. You control your automatic feeder by switching to lists via menus and submenus. In these lists, you can view and change values. The menu structure makes it easier to find a list quickly.

The menus that you require most frequently, such as **Animal control** , **Main menu**  and **Manual functions**  can be directly accessed with the press of button.

Experience shows that the **Animal list** is the list you will need most often . You can also access the animal list directly via the  key. You can change this default setting. You can also access the animal list via the animal control menu.

You can also assign an additional  key according to your needs in Device data under Function keys.

If you cannot see all the menus or submenus presented here, this is either because your automatic feeder is not equipped with the component in question, or the component was not activated during setup.

Note: If you know that your automatic feeder has a component that is not being displayed, contact your service technician so that he/she can adjust your setup. Never adjust the setup yourself.

ATTENTION Changing the setup can cause the automatic feeder to malfunction. If the automatic feeder malfunctions, your calves could suffer from malnutrition. Malnutrition can cause impaired growth and development, increased susceptibility to illness or even the death of your calves.

4.5.1 Symbols

Different symbols are displayed in front of and in several menus, submenus and lists.

4.5.1.1 Arrows



In automatic mode, arrow heads are shown in front of menus:

- ► A solid arrow head indicates that the menu contains submenus.
- ▷ An empty arrow head means that you can change settings here or start actions.

4.5.1.2 Angle brackets

< > Angle brackets around a menu or list mean that you can choose between menu options or list items. For example, you can select the appropriate calf from a list of animal numbers using the calf's animal number. If you see angle brackets at the top of the display, it means you can scroll left and right.

4.5.1.3 Square brackets

[] Values or terms are in square brackets. When you press  the value / list item begins to flash in the input field. You can now use the number keys to enter values or use   to select values from a list, such as [yes] or [no].

Note: If you enter a value in an input field and the value is too high or too low, this value will automatically be set to the highest (too high) or lowest (too low) possible value after you press .

4.5.1.4 Rod electrode free/covered

The following symbols appear at the top right of your display when animals are being fed in feed mode or when the mixer is being drained.



This symbol indicates that the mixer jar is full. The tip of the rod electrode is in the liquid.



This symbol indicates that the mixer jar is empty. The rod electrode is free of the liquid.

4.5.1.5 Animal identification and feed consumption



The antenna symbol after a station number, such as TR 1 for feeding box 1, indicates that a calf has been identified at this station.

✓ A check mark after the antenna symbol means that calf identified at this station may consume feed here.



A lock symbol after the antenna symbol means that calf identified at this station may not consume feed here. For example, this could be because the concentration of feed in the mixer jar does not match the feed settings for the identified calf.

- A hyphen after the station number indicates that no calf was identified at this station.

4.5.1.6 Plan tendency

The arrow to the right next to the animal number indicates the feeding phase the selected calf is now in.

↗ The feed quantity increases continuously, for example at the beginning of the feeding plan.

→ The feed quantity remains constant, for example in the middle of the feeding plan.

↘ The feed quantity is continuously reduced, for example at the end of the feeding plan.

f The calf is in the 40FIT period.

4.5.1.7 Marking

* Marked calves are indicated by an asterisk to the left of the animal number.

4.5.1.8 Alarms

! An exclamation mark to the left of the animal number indicates that a calf has triggered an alarm.

4.5.1.9 CalfCloud

C This symbol is displayed in the first line of automatic mode if a connection to the CalfCloud exists.

4.5.1.10 Sleep mode

The Förster-Technik logo shows you that no key has been pressed on the hand terminal for a longer period of time. The hand terminal is in sleep mode,

4.5.2 Navigation

You use the hand terminal's keys to navigate through menus, submenus and lists.

By choosing   you can:

- Move between the different submenus of a menu.
- Move between the items in a list, for example between **[yes]** and **[no]**.

By choosing   you can:

- Scroll through a list, for example through animal numbers. At the end of the list, the message "end of the list" will appear in the display.
- When you enter numbers, switch between whole numbers, for example from 1 to 2 to 3.
- Jump to the last menu item.

By choosing  you can:

- Confirm an entry.
- Acknowledge a prompt or message shown on the display.
- Confirm a selection.
- Open menus and submenus.
- To open input fields, which are indicated by square brackets.
- Switch from the number before the decimal place to the number after the decimal place in input fields.

By choosing  you can:

- Go back one menu, each time you press the key. You return to the starting menu by pressing this key multiple times.
- Exit the input field or return, without saving, to the number before the decimal place in an input field.

4.5.3 Menus

4.5.3.1 Animal control

You can choose  to open the **Animal control** menu. This menu contains all the submenus you require for daily calf monitoring. The numbers next to the submenus indicate the number of calves recorded in the submenu concerned.

- **Animal list.** You will see a table that shows your calves, sorted by different parameters, such as visits to the feeding box.
- **Entitlement.** You will see a list of your calves, sorted by feed entitlement.
- **Alarm.** You will see a list of the calves that have triggered an alarm.
- **Plan over date.** You will see a list of the calves that have a "plan over" date.
- **Additive** (optional) You will see a list of the calves that receive an additive.
- **40FIT Period.** You will see a list of the calves which are currently in the 40FIT period.
- **CalfRail** (optional). You will see a list of the calves which are registered at the CalfRail.
- **Marked.** You will see a list of calves that you have marked.
- **New.** You can view the newly registered calves here.
- **Double.** Here you assign a new animal number to calves that have been assigned a double animal number.
- **Unknown.** Here you can check whether and when your automatic feeder recorded unknown animal numbers. You can correctly register the identified calves.
- **All.** You will see a list of all calves.
- **Total consumption.** Several lists are displayed with the consumption amounts of all calves, individual calves and individual groups.
- **Print.** Here you can print out the alarm list and the feed list.

4.5.3.2 Main menu

You can choose  to open the main menu. This menu contains all submenus that you require for the daily operation of the automatic feeder.

- **Animal management**



- **Feeding**
- **Calibration**
- **Device data**
- **Cleaning**
- **Diagnosis**

4.5.3.3 Manual functions

You can choose  to open manual functions. Here you can start certain functions of the automatic feeder manually. For example, you can manually empty the mixer or dispense extra portions.

If you press , the automatic feeder switches from automatic to manual mode. The LED extinguishes and the automatic feeder is in offline mode.

The automatic feeder automatically returns to automatic mode after 20 minutes of inactivity. The Auto LED lights up green.

You can also actively switch the automatic feeder back to automatic mode. Press  until the message **Start automatic mode?** appears in the display. Confirm the message by choosing . The automatic feeder will return to automatic mode. The Auto LED lights up green.

You can control the following functions manually:

- **Extra portion.** Here you can dispense extra portions with or without additives.
- **Mixer: empty?.** The mixer is drained via the mixer drain valve.
- **Boiler water: start?.** Here you add water from the boiler to the mixer.
- **Powder: start?.** You start dispensing powder here.
- **Additive 1: start?.** This is where you start the dispensing for Additive 1.
- **Additive 2: start?.** This is where you start dispensing additive 2.
- **Mixer: start?.** You start the mixer here.
- **Feeding box.** You open the feeding box valve(s) here.
- **Boiler: fill?.** You automatically fill the boiler with water here.

- **Hoses: open?** Here you can open several valves simultaneously in order to completely drain all the lines of the automatic feeder of water.

5 Running the automatic feeder

5.1 Operating modes

You can run your automatic feeder in **rationed mode** or **ad lib mode** (emergency mode).

5.1.1 Rationed mode

In **rationed mode**, the automatic feeder uses animal identification. You can custom-feed your calves.

When calves are registered in a group, they receive feed according to that group's feeding plan. You can also feed individual calves differently from the group feeding plan. For example, you can feed extra portions to a single calf.

If the mixer jar is empty and a calf entitled to feed enters the feeding box and is identified, the automatic feeder prepares a feed portion that is specially adjusted for that calf.

- If the calf finishes this portion and is still entitled to feed, a second portion is prepared.
- If the calf is no longer entitled to feed, the feeding box valve is closed after the mixer is emptied and closed after a drain time that you have defined. You define the drain time together with your service technician during commissioning.
- If a calf stops feeding before finishing its portion, the feeder handles the remaining feed as follows:
 - The remaining feed is dispensed to each calf entitled to feed. The remaining feed is booked for the calf that actually finishes it.
 - Feed that remains in the mixer jar is automatically evacuated after a period that you define in **Device data > Portion > Draining**.

Note: This function should not be disabled. Otherwise, the risk of infection could increase.

5.1.2 Ad lib mode (emergency mode)

In **ad lib mode**, the feeder does not use animal identification. Whenever the mixer jar is empty, i.e., when the rod electrode is not covered by feed in the mixer jar, the automatic feeder prepares a portion of feed. Since the automatic feeder is not using animal identification, custom feeding is not possible. You can only feed calves together if they are the same age and have the same feed entitlement.

If there are several feeding stations, then the respective feeding box valves are opened.

⚠ WARNING Beware of the risk of burns on feeding box valves. During prolonged ad lib mode, feeding box valves become hot. You can burn your fingers or hand when touching these valves. For this reason, push the suction hose directly onto the mixer jar spout and disconnect the connector from the feeding box valve.

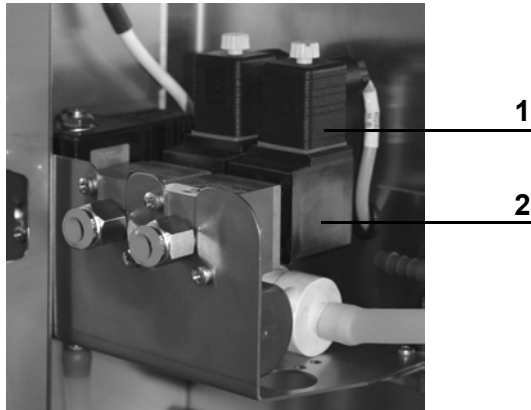

1	Female power connector
2	Box valve

⚠ ATTENTION Cleaning agent that enters the feed can be hazardous to the health of calves. Therefore, always disable all time-controlled cleaning menus and calibrations during ad lib mode.

5.2 CalfCloud

In this menu you can find the CalfCloud settings.

1. Move via  > **Device data** to the submenu **Cloud**.

- In **start?** you can establish the connection between the Cloud and the automatic feeder.
- Press . The fault menu **last error** will appear. The following error messages can be displayed:
 - **none.** There is no error.
 - **no eth. cable.** No Ethernet cable is connected. If necessary, contact your service technician.

- **no internet.** There is no Internet connection. If necessary, contact your service technician.
- **connect.error.** Connection fault to the server. If necessary, contact your service technician.
- In **terminate?** you terminate the connection to the Cloud and thus also the data transmission.
- **Status** shows you the current status of the connection to CalfCloud. **Online**, **offline** or **reconnecting** can be displayed.
- **Auth-Token** shows you the authentication key of the automatic feeder.

Note: With this token you can add the automatic feeder to the Cloud.

5.3 Routine tasks

Daily running of the automatic feeder involves routine tasks such as cleaning, feeding, animal control and care and maintenance. This chapter explains how the automatic feeder facilitates these routine tasks for you. See the appendix for check lists (see chapter **13.5.2** Maintenance intervals and activities, page **131**) with the necessary cleaning and maintenance tasks.

Daily tasks:

- Clean the automatic feeder.
- Feed calves.
- Animal monitoring.
- Care and maintenance.

Weekly tasks:

- Care and maintenance.

Tasks required every 4 months:

- If the automatic feeder does not have a mixer scale, recalibrate the water, milk substitute and cleaning agent.
- If the automatic feeder does not have a mixer scale, recalibrate the cleaning agent.

- Care and maintenance.
- Replace wearing parts.

Annual tasks:

- Thoroughly clean the automatic feeder.
- Replace wearing parts.
- Care and maintenance.

6 Cleaning the automatic feeder

You must clean all parts of the automatic feeder that come into contact with liquid or powder animal feed.

Note: If you have installed additional devices such as an additive dispenser, you must also follow the cleaning instructions in the operating manual for these devices.

Cleaning methods

You can use a range of cleaning methods, which you can also combine:

- You can clean some parts, such as the mixer, using programs that run automatically.
- You can clean parts such as the powder container manually.

Remember:

- You must follow all safety instructions in the safety data sheet for the cleaning agent you are using.
- You must always wear the protective gear, such as protective goggles and gloves, specified in the safety data sheet for the cleaning agent you are using.
- Undiluted cleaning agent may not be drained into the ground water or sewage system. Observe the recommendations in the safety data sheet for your cleaning agent and contact your water utility company and your sewage disposal company to find out which regulations apply to you.
- Observe the cleaning intervals recommended by the manufacturer of the cleaning agent as well as those recommended in this operating manual. (See chapter **13.5.2** Maintenance intervals and activities, page **131**).
- Only use the cleaning agents recommended in this operating manual.
- Observe the manufacturer's guidelines regarding the amount, temperature and concentration of cleaning agent used.
- Do all of the cleaning recommended in this operating manual.

ATTENTION Never use cleaning agents containing chlorine, as they can attack the materials of the automatic feeder and impair its function (see chapter **13.4** Automatic feeder material list, page **130**). If this happens, your calves may not receive enough feed. This can lead to malnu-

trition, which can cause impaired growth and development, increased susceptibility to illness or even the death of your calves.

6.1 Cleaning agents

Only use one of the following cleaning agents:

- HyClean K45

You can purchase this cleaning agent from your dealer.

⚠ WARNING Beware of **Chemical burns** from cleaning agents. The cleaning agent can cause chemical burns to your eyes or hands. Always wear goggles and protective gloves when using cleaning agents. Follow all the safety instructions listed in the safety data sheet for the cleaning agent and wear the specified safety equipment.

6.2 Preparing for cleaning

6.2.1 Cleaning programs that start automatically

⚠ WARNING Beware of **Chemical burns** from cleaning agents. The cleaning agent can cause chemical burns to your eyes or hands. Always wear goggles and protective gloves when using cleaning agents. Follow all the safety instructions listed in the safety data sheet for the cleaning agent and wear the specified safety equipment.

Fill the detergent tank with cleaning agent (optional).

6.2.2 Cleaning programs that are started manually

⚠ WARNING Beware of **Chemical burns** from cleaning agents. The cleaning agent can cause chemical burns to your eyes or hands. Always wear goggles and protective gloves when using cleaning agents. Follow all the safety instructions listed in the safety data sheet for the cleaning agent and wear the specified safety equipment.

Prepare for cleaning as follows:

1. Measure the necessary amount of cleaning agent. Consult the data sheet for the cleaning agent to determine the quantity recommended by the cleaning agent manufacturer.
2. Prepare the cleaning agent next to the automatic feeder.

6.2.3 Manual cleaning

- Powder discharge opening.

The scraper for cleaning is attached to the powder discharge opening.

- Powder container and dosing tongue.

Prepare for cleaning as follows:

1. Turn off the automatic feeder with the main switch and disconnect the power plug.
2. Empty the powder container.
3. Have a damp cloth ready to clean the outside of the automatic feeder.

ATTENTION Damage to the housing of the automatic feeder causes corrosion and impairs its function. Never use a high-pressure spray to clean the automatic feeder.

6.3 Cleaning the automatic feeder

You clean the automatic feeder as follows:

- Clean the mixer.
- Cleaning cycle.
- Clean the suction hose.
- Rinse the hose.
- Clean the powder container and dosing unit.
- Detergent pump with detergent lance.

6.3.1 Basic settings

In the **Settings** menu, you define values for the cleaning temperature, detergent amount (optional) and teat cleaning.



You define basic settings as follows:

1. Choose  > **Cleaning** > **Settings** to go to the **Temperature** submenu.
2. In the **Temperature** menu, you enter the desired temperature. You can enter values between 10 °C and 58 °C. The default setting is 45 °C.

Note: Consult the data sheet for the cleaning agent to determine the temperature recommended by its manufacturer and enter this value.

3. In the **Detergent** menu, (optional), you enter the desired amount of detergent. You can enter values between 0 ml/l and 25 ml/l. The default setting is 0 ml/l.

Note: Consult the data sheet for the cleaning agent to determine the amount recommended by its manufacturer and enter this value.

4. In the **Clean teat** menu, choose   [yes] if you want to rinse the inside of the teat with clean water. The water is pumped through the suction hoses and drained via the teat. The default setting is [no].

Note: Teat cleaning is important step to prevent infections and should therefore should always be selected.

6.3.2 Cleaning the mixer

You can clean the mixer automatically (at scheduled intervals) or manually, with or without detergent. A cleaning cycle consists of:

- **Pre-cleaning.**
- **Main cleaning** with the addition of cleaning agent. Depending on the configuration of your automatic feeder, the main cleaning cycle starts automatically or you must start it yourself. When it is started manually, you add the cleaning agent manually during the main cleaning cycle.
- **Rinsing.**

6.3.2.1 Mixer is cleaned automatically at scheduled intervals

If your automatic feeder features a detergent pump or the cleaning package, clean agent is added fully automatically. You must check each day to ensure that the cleaning agent container is full and that the cleaning agent is dispensed into the mixer.

⚠ WARNING Beware of **Chemical burns** from cleaning agents. The cleaning agent can cause chemical burns to your eyes or hands. Always wear goggles and protective gloves when using cleaning agents. Follow all the safety instructions listed in the safety data sheet for the cleaning agent and wear the specified safety equipment.

Note: The cleaning water is evacuated via the mixer drain valve.

You select automatic mixer cleaning as follows:

Two automatic mixer cleaning cycles at 07:00 hours and 22:00 hours are preset.

1. Choose  > **Cleaning > Mixer** to go to the **Clean mixer** submenu.
2. You can start automatic cleaning in the **start?** menu.
3. In the **Cleaning/day** menu, you enter the required number of cleaning cycles. You can set a maximum of four cleaning cycles.
Note: You should define at least one cleaning cycle per day in order to prevent unhygienic conditions.
4. In the **Cleaning 1** menu, you enter the desired time of day.
5. Repeat step 4 for additional **cleaning times**.
6. Activate or deactivate the **drainage mode** via the menu option with the same name. Drainage mode is activated by default.
If drainage mode is activated, then each time that the mixer is emptied to evacuate a residual portion to all of the available stations, all of the feeding box valves will be opened for one minute to allow the liquid remaining in the hoses to be drained.

Note: Start the cleaning at a time when there is minimal entitlement to feed so that your calves do not have to wait too long for feed.



Note: If there is still feed in the mixer jar at the set cleaning time, automatic cleaning will be postponed by a maximum of one hour. After that, any remaining feed will be evacuated via the mixer drain valve and the cleaning cycle will be started.

6.3.2.2 Manually starting mixer cleaning

You must add the cleaning agent to the mixer manually at the beginning of the main cleaning cycle if your automatic feeder **does not have a detergent pump or the cleaning package**. The cleaning agent is automatically evacuated.

To prevent unhygienic conditions when automatic mixer cleaning is disabled, perform an automatic cleaning at least 2 times a day without adding cleaning agent, and every other day with manually added cleaning agent.

You start manual mixer cleaning as follows:

1. Choose  > **Cleaning > Mixer** to go to the **Clean mixer** submenu.
2. Press  in the **start?** menu.
 - 2.1 Enter the required amount of detergent and confirm by choosing .

3. The message **Detergent** appears in the display.
4. **⚠ WARNING** Beware of **Chemical burns** from cleaning agents. The cleaning agent can cause chemical burns to your eyes or hands. Always wear goggles and protective gloves when using cleaning agents. Follow all the safety instructions listed in the safety data sheet for the cleaning agent and wear the specified safety equipment.

Pour the prepared cleaning agent into the mixer.

5. Confirm the filling by choosing .
- Cleaning will start.

Note: Start the cleaning at a time when there is minimal feed entitlement so that your calves do not have to wait too long for feed.

6.3.2.3 Cleaning the mixer jar manually

You must clean the mixer jar manually if it is visibly dirty, if you have disabled automatic cleaning or perform automatic cleaning less than twice a day.



⚠ WARNING There is a risk of injury due to automatic start-up. The automatic feeder automatically prepares a feed portion when it detects a calf entitled to feed. The stirring blades in the mixer jar start automatically and can crush or cut off your hand or fingers. Always turn off the automatic feeder with the main switch and disconnect the power plug before manually cleaning the mixer.

You clean the mixer manually as follows:





1. Press .
 2. Confirm **Exit automatic mode?** by choosing .
 3. Press and confirm **water bo. start?** by choosing .
- The mixer jar is filled with water.
4. Confirm **Mixer: empty?** by choosing .
 5. Press and confirm **water bo. start?** by choosing . Fill two-thirds of the mixer jar with water.
 6. **⚠ WARNING** Beware of **Chemical burns** from cleaning agents. The cleaning agent can cause chemical burns to your eyes or hands. Always wear goggles and protective gloves

when using cleaning agents. Follow all the safety instructions listed in the safety data sheet for the cleaning agent and wear the specified safety equipment.

Pour the prepared quantity of cleaning agent into the mixer.

7. Turn off the automatic feeder with the main switch and disconnect the power plug.
8. Clean the mixer jar with a soft brush or a soft sponge.
9. Empty the mixer jar by tipping out the contents into the drain or gully.
10. Insert the power plug again and turn on the automatic feeder again using the main switch.
11. Press  and confirm **water bo. start?** by choosing .

The mixer jar is filled with water.

12. Confirm **Mixer: start?** with  to clean the mixer with clean water.
13. Confirm **Mixer: empty?** by choosing .
14. Press  until the message **Start automatic mode?** appears in your display.
15. Confirm **Start automatic mode?** by choosing .

The automatic feeder is now operating in automatic mode again.

6.3.3 Cleaning cycle

In a cleaning cycle, you simultaneously clean the suction hoses and the automatic feeder.

Use the mounting holders provided for this procedure.

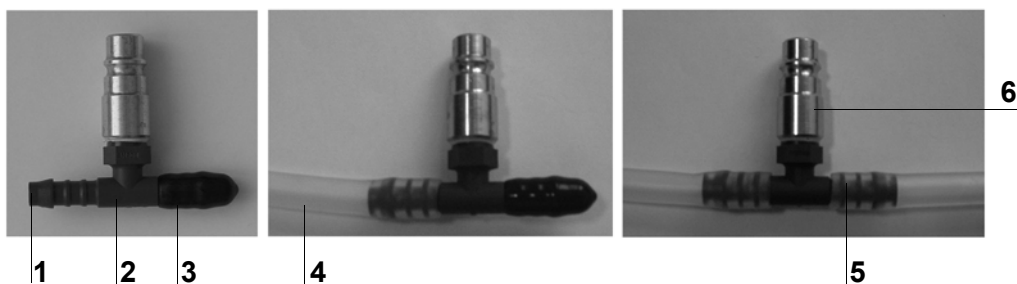

1 Hose nozzle	4 Suction hose (first station)
2 Cleaning adaptor	5 Suction hose (second station)
3 Rubber closing cap	6 Coupling for milk supply

Run the cleaning cycle at least **once a day** if automatic mixer cleaning is not enabled.

Run the cleaning cycle at least **once a week** if automatic mixer cleaning is enabled.

You set the cleaning cycle as follows:

1. Choose  > **Cleaning** to go to the **Circuit cleaning** submenu.
2. In the **Water/box** menu, you enter the desired amount of water. You can enter values from 0.5 l to 1.5 l. The preset default value is 1 l.

Note: The longer the hoses, the higher the value you must select.

3. Confirm **Start?** by choosing .

The message **Exit automatic mode?** appears in the display.

4. Confirm **Exit automatic mode?** by choosing .

5. In the **Detergent** menu (optional), you enter the desired amount of detergent. Use the amount recommended in the data sheet for your cleaning agent.

The automatic feeder will start the **Pre-cleaning**. After the mixer has been automatically evacuated, clear instructions are shown in the display. Follow these instructions:

- 5.1 On all feeding boxes, disconnect the suction hoses from the spouts that lead to the teats.
- 5.2 Position the hoses so that the rinsing water can drain directly into the gully.

6. Choose  to confirm that the instructions have been followed.

The automatic feeder continues the **pre-cleaning**. When pre-cleaning is completed, further instructions will appear in the display. Follow these instructions:



- 6.1 Suspend the suction hoses in the mixer using the mounting holders.
7. Choose  to confirm that the instructions have been followed.

The automatic feeder will start the **main cleaning cycle**. The remaining time appears in the display. When the main cleaning cycle is completed, further instructions appear in the display. Follow these instructions:

- 7.1 Position the hoses so that the rinsing water can drain directly into the gully.
8. Choose  to confirm that the instructions have been followed.

The automatic feeder will start the **rinsing** cycle.

- 8.1 Once the cleaning is finished, push the suction hoses back onto the hose nozzles of the respective teats.

9. Press  until the message **Start automatic mode?** appears in the display.
10. Confirm **Start automatic mode?** by choosing .

The automatic feeder is now operating in automatic mode again.

6.3.4 Manual suction hose cleaning

On the top left of the automatic feeder, there is a quick-release fastener for connecting the suction hose fitting. This quick-release fastener allows you to clean the suction hose manually using a sponge ball. The sponge ball is pushed by water through the suction hose.

Note: If other components such as pressure/suction sensors or hose pumps are installed between the suction hoses, they must be excluded from manual suction pump cleaning.

You clean the suction hoses manually as follows:

1. Turn off the automatic feeder using the main switch and disconnect the power plug.
2. Disconnect the suction hose from the connector on the teat and place the end in a container.
3. If pressure/suction sensors or hose pumps are installed, remove the incoming and outgoing suction hose and connect both hoses using a hose connector.
4. Disconnect the other end of the suction hose from the connector on the feeding box valve.
5. Insert the black sponge ball into the connector of the suction hose and connect it to the quick-release fastener.
6. Open the valve of the quick-release fastener.
The sponge ball is pushed through the suction hose.
7. Close the valve of the quick-release fastener once the sponge ball is in the container.
8. When cleaning is finished, reconnect the connector of the suction hose to the feeding box valve.
9. Push the suction hose back onto the hose connector of the teat.
10. If pressure/suction sensors or hose pumps are installed, push the incoming and outgoing suction hose back onto the appropriate connectors.
11. Clean the suction hoses of the other boxes using the same procedure.
12. Insert the power plug and turn on the automatic feeder again using the main switch.

13. Start automatic mode.
14. Clean the sponge ball and store it in a dry place.





6.3.5 Rinsing the hose

The suction hose from the automatic feeder to the teat can be automatically rinsed after each visit by the calf. This improves hygienic conditions by preventing the suction hose from clogging.

If a calf has finished the last portion of its feed entitlement, 0.25 l of warm water is dispensed into the mixer jar. If the calf drinks this warm water, this rinses the suction hose and removes residual milk from it.

Note: Hose rinsing is usually not enabled until the 14th day of the feeding plan because young calves typically do not like to drink water.

You set hose rinsing as follows:

1. Choose  > **Cleaning** to go to the **Hose rinsing** submenu.
2. In the **Group** menu, choose   to select a group (A, B, C or D) from the input field.
3. In the **activated** menu, choose   [yes] to enable rinsing and [no] to disable rinsing.
4. In the **as of plan day** menu, enter the day on which you want hose rinsing to start. The default setting is 14.

Hose rinsing is now enabled or disabled.

6.3.6 Cleaning the powder discharge opening

Check the powder discharge opening for milk powder deposits each day. Remove milk powder deposits immediately. By doing this, you prevent the powder discharge opening from clogging and dispensing insufficient milk powder.

ACHTUNG Insufficient milk powder in the feed causes undernourishment or malnutrition in your calves. This can cause impaired growth and development, increased susceptibility to illness or even the death of your calves. Check the powder discharge opening every day.

To clean the powder discharge opening, proceed as follows:

1. Turn off the automatic feeder using the main switch and disconnect the power plug.

⚠ WARNING There is a risk of injury due to automatic start-up. Do not reach into the hazardous area of the mixer. The mixer can start up automatically at any time, crushing or cut-

- ting off your fingers. Switch off the automatic feeder using the main switch, disconnect the power plug and only use the supplied scraper to clean the powder discharge opening.
2. Clean the powder outlet using the supplied scraper. Catch the loosened deposits and milk powder and dispose of them.
 3. Reconnect the power plug.
 4. Switch on the automatic feeder again using the main switch.
 5. Calibrate the milk powder (MP) (see chapter **10.2.1** Manually calibrating liquid and powder components, page **104**).
 6. Start automatic mode. Press **Esc** until the message **Start automatic mode?** appears in the display and confirm it by choosing **Enter**.

6.3.7 Thorough cleaning of the powder container with the dosing unit

During thorough cleaning of the powder container, milk powder deposits inside the powder container and dosing unit are removed. Thorough cleaning is required:



- If you shut down the automatic feeder.
- If you recommission the automatic feeder.
- If the feed that was added is contaminated with germs.

⚠ DANGER Lethal electric shock. The electrical components of the automatic feeder are live. Before opening the powder container, always turn off the automatic feeder using the main switch and disconnect the power plug.

⚠ WARNING There is a risk of injury due to automatic start-up. Do not reach into the hazardous area of the powder mixing unit. The powder mixing unit can start up automatically at any time, crushing or cutting off your fingers. Turn off the automatic feeder with the main switch and disconnect the power plug before reaching into the powder container.

To clean the powder container, proceed as follows:

1. Turn off the automatic feeder with the main switch and disconnect the power plug.
2. Remove the screws that hold the safety grid and remove it.
3. Clean the safety grid with a damp cloth.
4. Empty the powder container.

5. Remove the dosing tongue. To do this, remove the star nut located to the right of the powder discharge.
6. Clean the dosing tongue with a damp cloth and then dry the dosing tongue.
7. Use a dry brush and the supplied cleaning scraper to remove the milk powder deposits in the powder container and at the powder discharge opening.
8. Reinstall the dry dosing tongue. Retighten the star nut located to the right of the powder discharge.
9. Reinstall the safety grid. Retighten the screws.
10. Only add milk powder (MP) to the powder container if you want to recommission the automatic feeder immediately.
11. Connect the power plug and turn on the automatic feeder again using the main switch.
12. Enable milk powder dosing to fill the dosing star and the dosing unit.
 - 12.1 Go to  > **Diagnosis** to go to the **Powder motor** submenu and press  to start the motor.
13. Calibrate the milk powder (MP) (see chapter **10.2.1** Manually calibrating liquid and powder components, page **104**).



The automatic feeder is now ready for operation again.









6.3.8 Cleaning the detergent pump with detergent lance (option)

When the detergent is changed or the detergent use is interrupted, the detergent pump and the detergent lance must be cleaned.

⚠ WARNING **Chemical burns** due to the cleaning agents used. The cleaning agent can cause chemical burns to your eyes or hands. Always wear safety glasses and safety gloves when working with cleaning agents. Observe all safety instructions listed in the safety data sheet of the cleaning agent and wear the safety equipment required there.



6.3.8.1 Changing the detergent

1. Terminate the automatic mode by pressing  and confirm **Terminate automatic mode?** with .
2. Remove the detergent lance from the detergent container and firmly close the container.

3. Rinse the detergent lance with clear water.
4. Fill a bucket with clear water and put the detergent lance into the bucket.
5. Move via  > **Diagnosis** into the submenu **Motors**.
6. Confirm **Detergent start?** with  and keep the key pressed until approx. 1 liter of water has been dosed. The detergent pump is activated and the supply line thus rinsed.
7. Press  and confirm **Mixer: empty?** with .
8. Bore a hole for the detergent lance into the lid of the new detergent container.
9. Secure the detergent lance to the lid of the detergent container.
Note: Small vent holes in the lid prevent the contraction of the detergent container. Please refer to the manufacturer's instructions and national regulations.
10. Place the detergent container in the place provided for it.
11. Move via  > **Diagnosis** to the submenu **Motors**.
12. Confirm **Detergent start?** with  and keep the key pressed until the supply line is filled with the new detergent.
13. Carry out mixer cleaning (see **6.3.2.2** Manually starting mixer cleaning on page **49**).
14. Calibrate the detergent (see **10.2.1** Manually calibrating liquid and powder components on page **104**).
15. Start the automatic mode. Press  until **Automatic mode start?** is displayed and confirm with .

6.3.8.2 Discontinuing the detergent use

Note: If you discontinue the use of the detergent, you must manually clean the system.

1. Terminate the Automatic mode by pressing  and confirming the message **Automatic mode terminate?** with .
2. Remove the detergent lance from the detergent container and firmly close the container.
3. Rinse the detergent lance with clear water.
4. Fill a bucket with clear water and put the detergent lance into the bucket.
5. Move via  > **Diagnosis** into the submenu **Motors**.

6. Confirm **Detergent start?** with and keep the key pressed until approx. 1 liter of water has been dosed. The detergent pump is activated and the supply line thus rinsed.
7. Press  and confirm **Mixer: empty?** with .
8. Carry out mixer cleaning (see **6.3.2.2** Manually starting mixer cleaning on page **49**).
9. Start the Automatic mode. Press until **Automatic mode start?** is displayed and confirm with .

7 Transmitter and animal management

All menus for management of the list of all transmitters and the calves registered at the feeder can be found via  > **Animal management**.

7.1 Managing transmitters

7.1.1 Basics

7.1.1.1 Identification process at the station

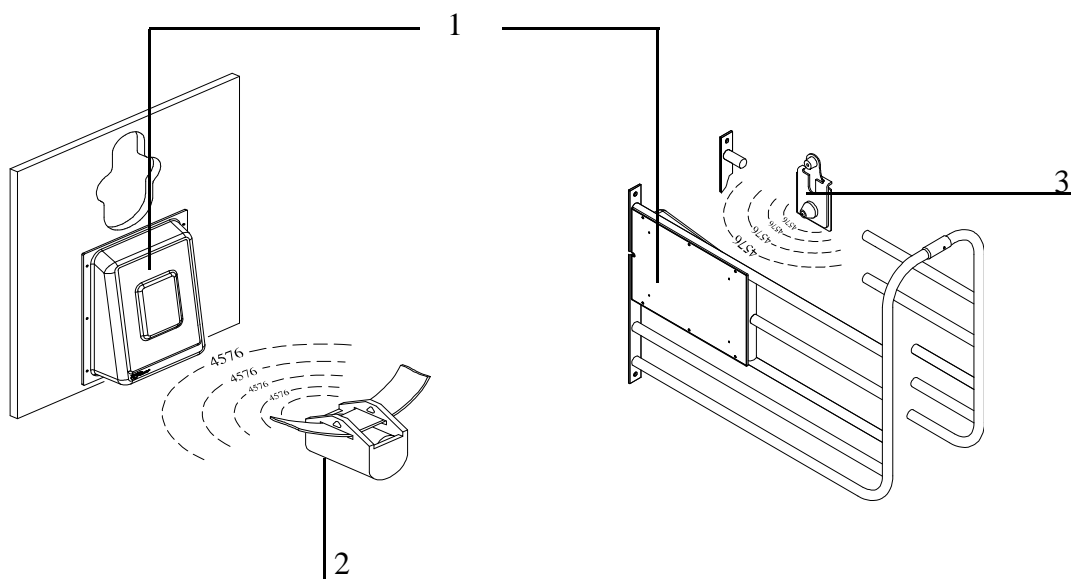

1	Antenna
2	Collar transmitter
3	Earmark transmitter

For identification purposes, each calf wears a collar with a transmitter or an earmark with a transmitter. The transmitter has a multi-digit number, which is also usually stamped into the transmitter housing. This **transmitter number** is sent from the transmitter to the antenna, which is part of the feeding box.

7.1.1.2 Relationship between transmitters and animal numbers

The multi-digit transmitter number is not well suited for quickly locating individual calves. For this reason, a calf is issued an animal number along with the transmitter number. The animal wears this animal number on an easily readable collar, or the animal number is put on the ear-

mark where it can be easily read. Up to 250 different animal numbers of up to six digits can be assigned to the calves.



7.1.2 Creating transmitter numbers

When the feeder is commissioned, existing transmitters have to be created once in the system. When you do this, each transmitter number is assigned one animal number of no more than six digits. These animal numbers are then available and can be used to register the calves.

7.1.2.1 Reading transmitter numbers

When creating new transmitter numbers, it is a good idea to have these read by the feeder. This saves you from typing in the numbers and eliminates the possibility of typing errors.



To set up the reading of transmitter numbers by the feeder, proceed as follows:

1. Choose  > **Animal management** > **Transmitters** to go to the **New** submenu.
2. Hold a transmitter next to the identification unit of a feeding box.
The number of the transmitter will be read in and displayed in the line after **No. †**. At the same time, the animal number to be newly assigned will be suggested in the **Animal no.** line.
Note: You can affect the suggested animal number by selecting an assignment scheme for the animal numbers in the **No.** line.
3. Check whether the suggested **animal number** is correct and, in the line **accept?**, press .
4. In order to allocate the newly read transmitter number to the displayed animal number, confirm the security prompt **Create new no. xxx for animal xx?** by choosing .

7.1.2.2 Manually entering transmitter numbers

Instead of reading the transmitters, you can also manually type in the transmitter numbers, if necessary

You manually enter transmitter numbers as follows:

1. Choose  > **Animal management** > **Transmitters** to go to the **New** submenu.
2. Enter the transmitter number in the **No.** menu and confirm it by choosing .

3. In the **Animal No.** menu, check the suggested animal number and confirm it by choosing .
4. Confirm **accept?** by choosing .
5. In order to allocate the newly read transmitter number to the displayed animal number, confirm the security prompt **Create new no. xxx for animal xx?** by choosing .

7.1.3 Assigning animal numbers

If the transmitter numbers are automatically read when new numbers are created, an animal number will be automatically suggested. You can choose from two schemes for the assignment of numbers.

7.1.3.1 Consecutive assignment of animal numbers

There is a counter which counts up for each new transmitter number as it is read. In this way, all of the transmitter numbers that are registered by the identification function are linked to consecutive animal numbers; e.g., from 1 to 50.

You set up consecutive assignment of animal numbers as follows:

1. Choose  > **Animal management > Transmitters** to go to the **New** submenu.
2. Select the **consecutive** option in **No.**
3. If necessary, in **next**, specify the animal number at which you want automatic reading of transmitters to start.

Note: If you use collars, it makes sense to start with 1 and read in the transmitters in order.

7.1.3.2 Assignment of animal numbers based on transmitter numbers

More and more often, calves are already equipped with an electronic earmark transmitter when they are born and keep this earmark their whole lives. The automatic feeder program has been adapted for this type of transmitter so that the registration process of the transmitters and calves can take place completely automatically.

You set up automatic assignment of animal numbers as follows:

1. Choose  > **Animal management > Transmitters** to go to the **New** submenu.
2. Select the **automatic** option in **No.**

3. In **Range**, define the part of the transmitter number that you would like to use as the animal number. The animal number can have a maximum of six digits.

For example:5-2 means that, counting from the right, the second to the fifth digits of the transmitter number will be used as the animal number. **6-1** means that, counting from the right, the first to the sixth digits of the transmitter number will be used as the animal number.



7.1.4 Editing transmitter or animal numbers

If necessary, (e.g., if a transmitter is lost), a transmitter number can be subsequently changed or deleted.

7.1.4.1 Changing the transmitter number



Manually changing the transmitter number

You manually change a transmitter number as follows:

1. Choose  > **Animal management** > **Transmitters** to go to the **Edit** submenu.
2. Select the transmitter number to be changed.
3. Change the transmitter number in the **No.** menu and confirm by choosing .

Reading the new transmitter number for the change

You read a new transmitter number as follows:

1. Choose  > **Animal management** > **Transmitters** to go to the **Edit** submenu.
2. Select the transmitter number to be changed.
3. Confirm **read?** by choosing .

A new menu is displayed, and the transmitter number flashes in the first line.

4. Hold the transmitter that you want to read next to the identification unit.
The number is automatically accepted in the first line.
5. Confirm **accept?** by choosing .

7.1.4.2 Changing the animal number

Like the transmitter number, the animal number can also be changed.

1. Choose  > **Animal management** > **Transmitters** to go to the **Edit** submenu.
2. Select the animal number you would like to change.

3. In the **Animal No.** menu, change the animal number that is currently allocated to the transmitter and confirm by choosing .

7.1.4.3 Deleting transmitter numbers

You delete transmitter numbers as follows:

1. Choose  > **Animal management** > **Transmitters** to go to the **Edit** submenu.
2. Select the transmitter number to be deleted and confirm **Delete** by choosing .

Note: You can only delete transmitter numbers of calves that are not registered (= status: available).

7.1.5 Deleting the transmitter number when canceling an animal

Generally, the collars (or earmarks) with the respective transmitters remain at the organization and are reused after the calf is taken out of the pen and its registration is canceled. For this reason, the default setting when canceling the registration of a calf is to not delete its transmitter number. If the calf's transmitter is, however, **not** reused but rather stays with the calf, (life-long earmark), make the following setting in the feeder:

1. Choose  > **Animal management** > **Cancel** to go to the **Settings** submenu.
2. Select the **yes** option in **Delete no.** When a calf's registration is canceled, the transmitter number is also deleted along with the animal number. This prevents an accumulation of unused transmitter numbers, which would use up the available storage space.

7.1.6 Retrieving transmitter statistics

You retrieve a transmitter statistic as follows:

1. Choose  > **Animal management** > **Transmitters** to go to the **Information** submenu.
2. An overview of the transmitters created in the system is displayed. The following is shown in the displayed list:
 - In the **Registered** menu, you check the number of registered transmitters or calves.
 - In the **Available** menu, you check the number of available transmitters.
 - In the **Free** menu, you check how many transmitters you can still create.

7.2 Registering animals

Calves are only fed at the feeder if they are also registered there. You can either manually register each calf or instruct the feeder to automatically register the calves. In the latter case, the calf is registered as soon as it enters the feeding station for the first time. This means that the manual registering of the calves is not needed.

During registration, the calf is allocated to one of four groups, A to D. The calf will then be fed in accordance with the feed and concentration plans of this group.

The group to which you allocate the calves depends solely on the feed quantity, concentration that you want to feed the calves. In this case, it does not matter which station the calves consume their feed in or which bay the calves have been housed in.

7.2.1 Registering animals manually

You register animals manually as follows:

1. Choose  > **Animal management** > **Register** to go to the **Animal** submenu.
2. Select one of the available (not yet registered) animal numbers.
3. In the **Group** menu, select the group to which the calf is to be allocated.
4. If the total feeding duration for the animal is to be shortened, you can set this under **Correction days** (see 8.5.5 Shortening or lengthening total feeding duration on page 74).
5. Confirm **Register?** with .
6. Confirm the prompt **Register animal xx in group X?** with .

Note: On its registration day, the animal receives the exact amount of feed, spread over the course of the day, as intended for the first day according to the feeding plan. If you have entered correction days, the animal will receive the feed that is intended for the corresponding day.

Note: For the next manual registration, the values last set will again be shown and can be used or changed for the current animal.

7.2.2 Registering animals automatically

If an animal that is not yet registered enters the feeding station for the first time, it can then be automatically registered. For automatic registration, three different modes can be set which

are described in detail in the following three sub-sections. The following table presents an overview of this.

Overview of the three modes for automatic registration

Automatic registration mode	Transmitter number being identified	
	available	unknown
deactivated	Warning Unknown transmitters	Warning Unknown transmitters
available transmitters	Animal will be registered	Warning Unknown transmitters
all transmitters	Animal will be registered	Transmitter is created, new animal number is assigned, animal is registered

7.2.2.1 Deactivating automatic registration

Automatic registration is deactivated by default. You can restore this setting at any time:

You deactivate automatic registration as follows:

1. Choose  > **Animal management > Register** to go to the **Automatic** submenu.
2. Select **Mode no** and confirm by choosing . Automatic registration is then deactivated.

Note: When the registration function is deactivated, the **unknown transmitters warning** will be triggered if an unregistered calf enters a station.

7.2.2.2 Only automatically register available transmitters

Automatic registration shortens the registration process for the calves. When doing this, you can specify that only calves can be registered whose transmitter numbers are already in the system. If an available transmitter number is registered in the identification unit, the corresponding calf will be automatically registered. Calves or transmitter numbers that have not yet been created in the system will trigger the **Unknown transmitter number** warning.

Proceed as follows to set up automatic registration of available transmitters:

1. Choose  > **Animal management > Register** to go to the **Automatic** submenu.
2. In **Mode** select the **available** option.
3. In **Group**, choose the group in which you want to automatically register the calves.

Note: The registration of calves that are to be removed should only be canceled after they have left the bay, as they will otherwise automatically be reregistered when they enter the station and will then be returned to the start of the feeding plan.

7.2.2.3 Creating transmitter numbers and automatically registering calves

To shorten the registration process even more, you can specify that calves can also be registered if their transmitter numbers are not known in the system. This eliminates the need for reading or manual entry of transmitter numbers. In this case, if an unknown transmitter number is registered in the identification unit, this transmitter number is automatically created in the system and a new animal number is issued and registered at the same time.

Note: When creating new transmitters and animal numbers, the animal number will either be produced consecutively or as a part of the transmitter number (see 7.1.3 Assigning animal numbers on page 61).

Proceed as follows to create transmitter numbers and automatically register calves:

1. Choose  > **Animal management** > **Register** to go to the **Automatic** submenu.
2. In the **Mode** menu, select the **All** option.
3. In the **Group** menu, choose the group in which you want to automatically register the calves.

Note: Calves **without collars** should never be in the bay. They could push other animals out of the way and steal remaining amounts of feed.

7.3 Canceling animals or animal groups

Individual calves or a group of calves that are no longer being fed according to the plan must be removed from the pen compartment and their registration canceled. The same applies to calves whose feeding plan has expired.

7.3.1 Canceling an individual animal's registration

You cancel an individual animal's registration as follows:

1. Choose  > **Animal management** > **Cancel** to go to the **Animal** submenu.
2. Select the required animal number.
3. In the **Plan end** menu, you check how much longer the calf is to be fed according to the plan.

4. In the **MP** menu, you can check how much milk powder the calf has consumed from the start of registration to its cancellation.
5. Confirm **cancel?** by choosing in order cancel a calf.

ATTENTION There is a risk of malnutrition if calves do not receive any feed. Malnutrition can cause impaired growth and development, increased susceptibility to illness or even death of the calves. You must use an alternative method to supply your calves with feed.

Note: If you have chosen the value **All** or **Available** for the **automatic registration mode**, you should remove unregistered calves from the bay, because otherwise they will be automatically registered again.

7.3.2 Canceling a group registration

You can cancel a group registration as follows:

1. Choose  > **Animal management** > **Cancel** to go to the **Group** submenu.
2. Select the required group.
3. In the **Registered** menu, you can see how many calves are being fed according to the corresponding plan.
4. In the **Weaned** menu, you can see how many calves have already finished the feeding plan and therefore no longer receive any feed.
5. Confirm **Cancel?** by choosing if all calves of the group are to be canceled regardless of whether they are registered or weaned calves.
6. Confirm the security prompt **Cancel animals in group?** by choosing .

7.3.3 Canceling the registration of weaned animals



You can cancel the registration of weaned calves as follows:

1. Choose  > **Animal management** > **Cancel** to go to the **Weaned animals** submenu.
2. Confirm **Cancel?** by choosing if you want to cancel weaned calves.
3. Confirm the security prompt **Cancel animals?** by choosing .

7.4 Transferring animal registrations

You can transfer calves registered at an automatic feeder to another group at any time.

To transfer a registered calf to another group, proceed as follows:

1. Choose  > **Animal management** to go to the **Transfer** submenu.
2. Select the required calf.
3. Select the required feeding group in the **Group** menu.
4. Confirm the prompt **Register animal xx in group X?** by choosing .

Note: When registration is transferred, the feeding day is retained; the calf will **not** be reset to the start of the feeding plan (= to plan day 1).

8 Feeding

You may only use the automatic feeder to prepare liquid feed for your calves.

Note: If you have installed additional peripheral devices such as the additive dispenser, you must also follow the instructions in the operating manual for these devices.

8.1 Replenishing feed

To ensure that the automatic feeder can prepare feed, you must make sure that the powder container are always filled.

8.1.1 Filling the milk powder container

Only add milk powder (MP) that is suitable for feeding calves.

ATTENTION Make sure that no paper or other foreign bodies enter the powder container. The dosing mechanism could otherwise be damaged or the dosage accuracy impaired. As a result, your calves could receive insufficiently concentrated feed and would not be supplied with any or sufficient feed. This can lead to malnutrition, which can cause impaired growth or development, increased susceptibility to illness or even the death of your calves.

ATTENTION If the powder hopper is empty, no warning is displayed. Feeder operation is continued without a milk substitute. This can result in your calves only receiving water. This can lead to malnutrition, which can cause impaired growth and development, increased susceptibility to illness or even the death of your calves.

8.2 Feed preparation

During preparation of feed, the liquid components are dispensed first. These components are supplied from the to the mixer jar and are heated up in the process.

If the mixer jar is filled up to the rod electrode with fluid (water or milk), milk substitute (MP) will be dispensed from the powder container into the mixer jar according to the feeding plan.

8.3 Feed distribution

For an internal station, feed is distributed in **preference mode**. If an IFS station is connected, feed can be distributed in **parallel mode**.

In preference mode, one animal is always fed after the other. When the calf sucks the feed, the mixed feed in the mixer is conveyed to the sucking teat via the suction hoses and the opened feeding box valve.

8.4 Feeding

When you register your calves for the automatic feeder, you assign them to a group (A, B, C or D). Calves in the same group are usually fed according to the feeding plan of their group. See the appendix for examples of default feeding plans (see chapter **13.1** Standard feeding plans, page **127**).

You can also choose between rationed feeding and 40FIT feeding.

8.4.1 40FIT feeding

A key goal of calf rearing is to ensure that calves get off to the best possible start in life and to prepare them for optimum performance as milk cows later in life. Intensive feeding in the first 40 days of life is an important prerequisite in reaching this goal.

By changing the feeding plan to 40FIT/ rationed, you can activate the 40FIT function in any period. During this period, feed is freely available to calves all day long. The defined feed quantity is only a reference value for calculating alarm levels and is not a limit.

To ensure that the calves do not eat too much, the amount consumed per visit is limited by the defined maximum quantity. In addition, a blocking period can be defined during the 40FIT feeding phase. This means that the calf can only consume the defined maximum quantity during this period. After the subsequent blocking period, the maximum quantity can be consumed again, and the remaining amounts from the previous blocking period are not carried over.

If a feeding period is defined as rationed, the feed quantity to which the calf is entitled is spread across multiple intervals.

The standard A and B feeding plans correspond to the 40FIT feeding concept. The standard A and B feeding plans correspond to the rationed feeding concept.

Note: Contact your feed consultant to find out which feeding plan is best for your calves.

8.4.2 Interval feeding program

The feed quantity to which the calf is entitled each day is spread across multiple intervals. (**Interval feeding program**). Feed entitlements are saved from interval to interval and can be



consumed at any time once a **minimum saved amount**. Without a minimum saved amount, the calves would consume feed portions that are too small. The feed portion is not released until the minimum saved amount defined in the feeding plan has been reached. As a result, the minimum saved amount lets you indirectly define the number of meals that a calf receives. From 8 pm to midnight, a calf can consume the rest of the feed to which it is entitled, even if it has not reached the minimum saved amount. By defining the maximum amount in the plan, you ensure that a calf does not eat too much. You use the **maximum amount** in the feeding program to define how much feed a calf can consume at once. The interval feeding concept is tailored to the needs of your calves. You can set up the feeding plan so that young calves are supplied with several small portions, e.g., 1.5 liters of feed 4 times a day, at the beginning of the feeding period. When the calves get older, you reduce the number of feeding times by increasing the minimum saved amount to 1 feeding time per day. The increasing intervals between the feeding times encourage the consumption of concentrate and roughage. At the same time, you reduce the tendency toward cross-sucking. See the appendix for an example of an interval program (see chapter **13.2** Basic principle of interval feeding, page **129**). After consuming its maximum quantity, a calf is excluded from feed distribution for 2 hours, and saved feed quantities are retained.



8.4.3 Preferred feeding

You can give preference to certain calves for the consumption of feed. If a preferred calf enters a feeding box, its feed is immediately dispensed. You can give calves preference based on the following criteria:

- Calves that have triggered an **alarm**.
- All calves up to a certain **feeding day**.
- One **station** and all calves that feed there.

You set a preference as follows:





1. Choose  > **Feeding** to go to the **Priority** submenu.
2. In the **Alarm** menu, choose   [yes] to prefer or [no] in order not to prefer calves with alarm messages.
3. In the **till feed day** menu, enter the feeding day until which you want to give a calf preference.

4. In the **Box** menu, choose   to select the feeding box at which preferred feeding is to take place, or select **[none]**.

8.4.4 Extra portions

You can manually start the preparation of extra portions at any time. Extra portions are dispensed to a calf in addition to the daily quantity to which it is entitled according to the quantity plan. These portions are not offset against the quantity plan.

You enable dispensing of extra portions as follows:

1. Choose  to go to the **Extra portion** submenu.
2. In the **Output** menu, choose   to select the output location:
 - In the **Bucket** menu, you output the feed portion into a prepared bucket via the gully drain.
 - In the **Mixer** menu, you output the extra portion into the mixer.
 - Transfer the contents of the mixer manually.
 - After each partial portion, confirm **Mixer empty?** by choosing .
 - In the **Station X** menu, you output the extra portion via the selected valve outlet.
 - Select a **feeding box**.
 - Disconnect the hose from the valve outlet
 - Drain the feed into a container suitable for feeding calves.
3. In the **Set quantity** menu, specify the quantity for the extra portion. You can enter values between 0.3 and 65 liters. The default setting is 5 liters.
4. In the **Temperature** menu, specify the required temperature for the extra portion. The temperature may not exceed **45°C** . The default setting is the value that you defined in  **> Device data > Portion > Set temp..**
5. In the **Concentr.** menu, specify the required concentration for the extra portion to be mixed. You can enter values between 5 and 255 g/l. The default setting is 150 g/l.
6. In the **Additive** menu (optional), specify the amount of additive for the extra portion. You can enter values between 1 and 99 g/l.





7. Confirm **Start?** by choosing  in order to start dispensing the extra portion.

8.5 Checking and changing feeding data for individual animals

In the **Single animal** menu, you check and change feeding parameters for individual calves.

8.5.1 Group membership

You allocate a registered calf to a group as follows:

1. Choose  > **Feeding** to go to the **Animal** submenu.
2. Choose   to select the required animal number.
3. In the **Group** menu, choose   to select A, B, C or D.

The prompt **Transfer animal no. in group [A, B, C or D] ?** will appear.

4. Confirm the message by choosing .

The calf is registered in the required group.

8.5.2 Feed quantity

You change the feed quantity for an individual calf as follows:

1. Choose  > **Feeding** > **Animal** to go to the **Feed** submenu.
2. In the **Deviation** menu, enter the number of days (validity period) on which the calf is to receive a modified feed quantity. You can enter values between 0 and 99. The default setting is 0 days.
3. In the **Quantity** menu, you enter the additional feed quantity that the selected calf is to receive. You can enter values between 0 and 25 l. Use the **(+/-)** key to enter a minus sign (-) in front of the number, for example -2 l, in order to reduce the feed quantity and a plus sign (+), for example +2 l, to increase it. The default setting is 0.0 liters.
4. In the **Plan** menu, you can check the feed quantity to which the calf is entitled according to the plan.
5. In the **Feed** menu, you can check the feed quantity to which the calf is entitled for the defined period.

After the validity period, your corrections will expire and the calf will again be fed according to the feeding plan of its group.

8.5.3 Feed concentration

You change the feed concentration for an individual calf as follows:

1. Choose  > **Feeding** > **Animal** to go to the **Conc.** submenu.
2. In the **Deviation** menu, enter the number of days (validity period) on which the calf is to receive a modified feed concentration. You can enter values between 0 and 99. The default setting is 0 days.
3. In the **Quantity** menu, you enter the required change in concentration. You can enter values between 0 and 255 g/l. Use the (+/-) key to enter a minus sign (-) in front of the number, for example -10 g/l, in order to reduce the concentration and a plus sign (+), for example +10 g/l, to increase the concentration. The default setting is 0 g/l.
4. In the **Plan** menu, you can check the feed concentration to which the calf is entitled according to the plan.
5. In the **Concentration** menu, you can check the feed concentration to which the calf is entitled after the change.

After the validity period, your corrections will expire and the calf will again be fed according to the feeding plan of its group.

8.5.4 Weight





You set the weight as follows:

1. Choose  > **Feeding** to go to the **Animal** submenu.
2. In the **Weight** menu, you set the weight of the animal.

8.5.5 Shortening or lengthening total feeding duration

You can shorten or lengthen the total feeding duration for a calf. To do this, you must "move" the animal to the desired plan day.

You change the total feeding duration as follows:

1. Choose  > **Feeding** to go to the **Animal** submenu.
2. Choose   to select the required animal number.
3. In the **Plan day** menu, you can check which day the calf is on in the feeding plan.
4. Confirm **Plan day** by choosing .

5. In the **Feed. day** menu, you can check the number of days that have passed since the calf was registered.
6. In the **Correction** menu, you enter the number of days by which you want to reduce or extend the feeding duration according to the group feeding plan for the calf. The maximum possible extension corresponds to the number of feeding days.
Note: To extend the feeding duration, use the (+/-) key to enter a negative number such as -2. To shorten the feeding duration, use the (+/-) key to enter a positive number such as +2.
7. In the **Plan day** menu, you can check the calf's new plan day.
8. In the **Plan end** menu, you can view the number of days after which the feeding plan will end.
9. In the **Feed** menu, you can check the feed quantity that the calf will receive on the current day (today).
10. In the **Conc.** menu, you can view the feed concentration that the calf will receive on the current day (today).

8.6 Feeding plans

The following plans are taken into account when the feed is prepared:

- Quantity plan
- Concentration plan
- Quantity limitation plan

When you registered your calves for the automatic feeder, you assigned them to a group (A, B, C or D). A quantity plan, a concentration plan and a quantity limitation plan are created for each group.

If you are running an automatic feeder with animal identification, calves from different feeding groups, for example group A and group B, can be housed in the same bay or consume feed at the same station.

Below is an example of a feeding plan.

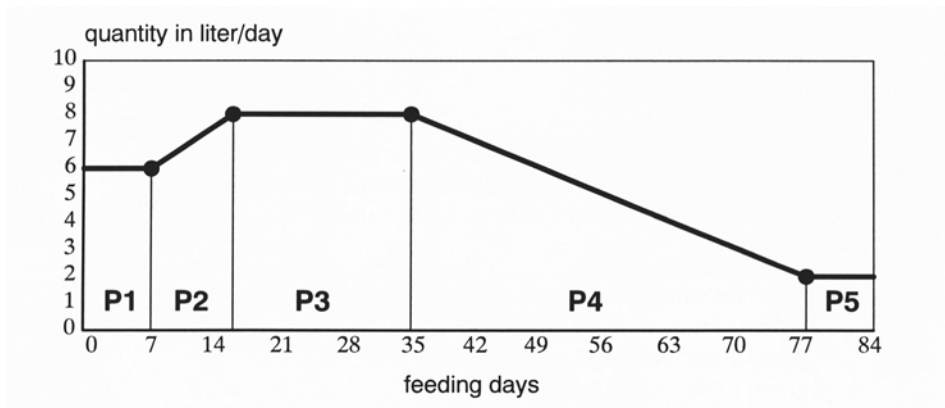

You can divide each feeding plan into up to 5 periods (P 1, P 2, P 3, P 4 and P 5).

The day on which a calf is registered corresponds to the first day of its feeding plan (if no correction days were entered).

Your automatic feeder has preset default plans. You can find the default feeding plans in the appendix of this operating manual (see chapter **13.1** Standard feeding plans, page **127**).

These default plans are based on general experience. Only change default plans if, based on your experience in calf rearing and your rigorous monitoring efforts, you are certain that your calves will not suffer from undernourishment or malnutrition. Malnutrition can cause impaired growth or development, increased susceptibility to illness or even the death of your calves.



8.6.1 Changing the default quantity plan

You can alter the default quantity plan according to 2 different feeding principles: the 40FIT feeding principle (F) or the rationed feeding principle (R).

Depending on the feed entitlement, the feed is distributed across one or more portions. These portions can vary in size. Only the feed amount that is actually consumed is recorded.



ATTENTION If you deviate from a default quantity plan, a calf may not receive sufficient feed. This can lead to malnutrition, which causes impaired growth and development, increased susceptibility to illness or even the death of your calves. Consult your feed consultant before making changes that could have harmful effects.

Proceed as follows to change a default quantity plan based on the 40FIT feeding concept:





1. Choose  > **Feeding** > **Plans** > **Feed** to go to the **Quantity** submenu.
2. Choose   to select the desired group.

Groups A and B are assigned to 40FIT plans by default.

The feeding plan of this group is shown in the display.

3. Choose   to select the feeding concept for the group: **40FIT/rationed**
4. In the **Days (P 1)** column, you enter the length of the feeding period. You can enter values from 2 to 99. The default setting is 35 days.
5. In the **from (P 1)** column, you enter the starting value for the feeding quantity. You can select values from 0.1 to 25.5 liters in 0.1 liter increments. The default setting is 8 liters.
Note: The quantity entered here is not a limit, but a reference value for calculating alarm levels for 40FIT feeding (F) or as a limit for rationed feeding (R).
Note: Observe the table in chapter 8.6.2 Changing the default concentration plan, page 78.
6. In the **to (P 1)** column, you enter the final value for the feeding quantity. You can select values from 0.1 to 25.5 liters in 0.1 liter increments. The default setting is 6 liters.
Note: The quantity entered here is not a limit, but a reference value for calculating alarm levels for 40FIT feeding (F) or as a limit for rationed feeding (R).
Note: Observe the table in chapter 8.6.2 Changing the default concentration plan, page 78.
7. Activate 40FIT feeding at the end of a period by choosing **F** or activate rationed feeding by choosing **R**.
 If necessary, repeat steps 1 to 7 for **P 2** to **P 5**.
8. In **Duration**, you can check the total duration of the feeding plan.
9. In **Quantity**, you can check the total feed quantity that a calf will receive according to this plan.
Note: This quantity is a guide value for 40FIT feeding.

Proceed as follows to change a default quantity plan based on the rationed feeding concept:

1. Choose  > **Feeding > Plans > Feed** to go to the **Quantity** submenu.
2. Choose   to select the desired group.
 Groups C and D are assigned to rationed feeding plans by default.
 The default feeding plan of this group is shown in the display.
3. Choose   to select the feeding concept for the group: **rationed**

4. In the **Days (P 1)** column, you enter the length of the feeding period. You can enter values from 2 to 99. The default setting is 2 days.
5. In the **from (P 1)** column, you enter the starting value for the feeding quantity. You can select values from 0.1 to 25.5 liters in 0.1 liter increments. The default setting is 5 liters.
Note: The quantity entered here serves as a limit.
Note: Observe the table in chapter **8.6.2** Changing the default concentration plan, page **78**.
6. In the **to (P 1)** column, you enter the final value for the feeding quantity. You can select values from 0.1 to 25.5 liters in 0.1 liter increments. The default setting is 5 liters.
Note: The quantity entered here serves as a limit.
Note: Observe the table in chapter **8.6.2** Changing the default concentration plan, page **78**.
7. If necessary, repeat steps 4 to 6 for **P 2** to **P 5**.
8. In the **Duration** menu, you can check the total duration of the feeding plan.
9. In the **Quantity** menu, you can check the total feed quantity that a calf will receive according to this plan.

8.6.2 Changing the default concentration plan

There is a concentration plan for every feeding plan. Just like the feeding plan, the concentration plan can be divided into 5 periods. The default setting is one period, **P 1**. The length of the quantity plan periods is, however, not bound to the length of the feeding plan periods.

For example, if you want to keep the feed concentration the same for all feeding periods, in **P 1** in the **Days** column, you can enter the same number that is specified for the total number of feeding days in the **Duration** menu option.

The default milk substitute concentration is **150 g/l**. Periods **P 2** to **P 5** are not activated by default.

Note: Many milk powder manufacturers recommend the **MP concentration** (MP = milk substitute) **per liter of feed** on their packaging. However, the program of the automatic feeder requires you to enter the **MP concentration per liter of water**. To make this conversion easier, use the following conversion table, which is also included in the appendix (see chapter **13.3** Milk powder (MP) conversion table, page **129**).

Required concentration (in g/l feed)	Setting in concentration plan (in g/l water)	Dry matter (in %/l feed)
100	111	10.0
105	117	10.5
110	124	11.0
115	130	11.5
120	136	12.0
125	143	12.5
130	149	13.0
140	163	14.0
150	176	15.0
160	190	16.0
170	205	17.0
180	220	18.0
190	235	19.0
200	250	20.0

For example: The feed concentration specified on the of the milk substitute (MP) package is **130 g/l feed**. When you enter the feed concentration plan in your automatic feeder, enter **149 g/l (water)** according to the conversion table.



Required concentration (in g/l of feed)	Setting in concentration plan (in g/l of water)	Dry matter (in %/l feed)
125	143	12.5
130	149	13.0
140	163	14.0

*) Guide value

ATTENTION If you deviate from the default concentration plan, a calf could receive feed which is insufficiently concentrated. This can lead to malnutrition, which causes impaired growth and development, increased susceptibility to illness or even the death of your calves. Ensure that the changes will not having any harmful effects, for example by rigorously monitoring your calves.

The length of the concentration plan periods does not have to match the length of the quantity plan periods. If the concentration plan is shorter than the quantity plan, at the end of the concentration plan a message will appear in the display of your hand terminal. The concentration of the last feeding portion fed to the calf will be maintained until the end of the quantity plan.

You change a default concentration plan as follows:

1. Choose  > **Feeding** > **Plans** > **Feed** to go to the **Concentration** submenu.
2. Choose   to select the desired group (A, B, C or D).

The default concentration plan of this group will be shown in the display.

Note: Unlike for the quantity plan, only P 1 is assigned by default. However, here too, you can activate up to 5 periods (**P 1** to **P 5**). If you activate a period, for example P 2, the following period P 3 will automatically become visible.

3. In **P 1**, you enter the duration (**Days** column) of the change in concentration and the respective starting value (**from** column) and final value (**to**) of the feed concentration. You can enter values between 5 and 255 g. The default setting is 150 g.
4. If necessary, repeat step 3 for **P 2** to **P 5**.
5. In **Duration**, you can check the total duration of the concentration plan.
6. In **Quantity**, you can check how many kilograms of milk substitute (MP) a calf will receive according to the modified plan.

8.6.3 Changing the default quantity limitation plan



In the quantity limitation plan, you use entitlement intervals to define the number of meals (amount consumed) a calf receives per day.

Note: You can increase or reduce the feed quantity in steps of 0.1 l. Depending on the feed entitlement, the feed is distributed across one or more portions. These portions can vary in size.



To prevent overeating, the amount consumed is limited by the maximum quantity defined in the feeding plan. This means that the calves receive no more than the maximum feeding quantity at each meal.

ATTENTION If you deviate from the default quantity limitation plan, a calf may not receive sufficient feed. You may not reduce the defined quantity limitation values any further, especially toward the end of the feeding period. This can lead to malnutrition, which causes impaired growth and development, increased susceptibility to illness or even the death of your calves. Ensure that the changes will not have any harmful effects, for example by rigorously monitoring your calves.

You change a default quantity limitation plan as follows:

1. Choose  > **Feeding > Plans > Feed** to go to the **Limitation** submenu.
2. Choose   to select the desired group (A, B, C or D).

The default quantity limitation plan for this group will be shown in the display.

3. In the **Days (P 1)** column, you enter the duration of the change. You can enter values between 1 and 99 days. The default setting is 14 days.
4. In the **Min (P 1)** column, you enter the minimum saved amount in liters. You can enter values between 0.2 and 9.5 liters. The default setting is 2 liters.
5. In the **Max (P 1)** column, you enter the maximum amount in liters. You can enter values between 2.5 and 9.5 liters. The default setting is 2.5 liters.
The cursor will jump to the next feeding period (**P 2**).
6. Repeat steps 3 to 5 for **P 2** to **P 5**.
7. In the **Block 40FIT** line, you enter the amount of time that a calf in the 40FIT period is blocked after consuming its maximum quantity. You can enter values between 00:30 hours and 02:30 hours. The default setting is 02:00 hours.
8. In the **Duration** line, you can check the total duration of the quantity limitation plan in days.
9. In the **Start time** line, you enter the time from which the saving of the feed quantity should begin. The time is calculated from 00:00. By choosing   you can set a deviation of +2 or - 2 hours.
Note: If you feed your calves according to the 40FIT principle, or if you use an electrolyte as an additive, you cannot set the start time.

8.7 Winter feeding plan

If your automatic feeder features MultiReader identification with an integrated temperature sensor, you can define a winter feeding plan for your calves. You can adjust the feed quantity or concentration so that your calves receive more feed when temperatures drop.



If the ambient temperature rises above a temperature limit that you define, the winter feeding plan is automatically disabled.

Note: The winter feeding plan can only be defined for all calves (regardless of feeding group), not for individual calves.

You set the winter feeding plan as follows:

1. Choose  > **Feeding > Plans** to go to the Winter feeding plan submenu.
2. In the line labeled **Check temperature?**, check whether the MultiReader identification system is equipped with a temperature sensor so that it can measure the temperature.

Note: If the message **No measurement possible** appears, you will not be able to activate the Winter feeding plan.



3. In the **Active** menu item, you choose   [yes] to activate the winter feeding plan and [no] to deactivate the winter feeding plan. The default setting is [no].
4. In the **Current temp.** menu option, you can check the current temperature at a time of 00:00.
5. In the **Ø temp.** menu option, you can check the average temperature over the last 3 days.
6. In the **Status** menu option, you can check whether an increase has been entered (**Increase on**).
7. In the **Limit temp.** menu option, you specify the minimum temperature at which you want feed to be increased.
8. In the **Increase** menu option, you specify the percentage by which you want to increase the feed quantity or feed concentration.

8.8 Alarm levels

You use alarm levels to determine the time or value that triggers an alarm. Alarm levels are defined for groups. You can set alarm levels for:

- Feed consumption.
- Drinking speed.
- Feeding break.

You set alarm levels as follows:

1. Choose  > **Feeding > Alarm level** to go to the **Feed** submenu.
2. Choose   to select the desired group (A, B, C or D).
3. In the **after** menu, you enter the amount of time (hours) that can pass after a feed release before an alarm is triggered. The setting applies to the current day. The preset default value is 3 hours. You can enter values from 0 to 9 hours.
4. In the **as of** menu (only for 40FIT), you enter the earliest time of day at which an alarm is triggered if the percentage entered for feed consumption is not reached. The setting applies

-
- to the current day. The default setting is 12:00 hours and 30%. You can enter times from 08:00 to 12:59 and 0 to 99%.
5. In the **yesterday** menu, you enter the minimum percentage of feed a calf must have consumed yesterday so that no alarm is triggered. The preset default value is 80 %. You can enter values from 0 to 99%.
 6. In the **Dr. speed** menu, you enter the percentage of drinking speed that a calf must reach so that no alarm is triggered. The preset default value is 70 %. You can enter values from 0 to 99%. The average, drinking speed of a particular calf on the current day (today) is compared to its average drinking speed on the last 3 days. If the entered value is not reached, an alarm will be triggered.
 7. In the **break w.o. add.** menu, you specify how often a calf may interrupt its feeding (that is, drink less than its entitled quantity) before an alarm is triggered. The default setting is 3 breaks. You can enter values from 0 to 99.

9 Animal control

You can use your automatic feeder to monitor animals.

Note: You can only obtain information about calves if you run your automatic feeder with animal identification.

Choose  to go to the menus for animal control. The number next to the submenus shows the number of calves recorded in the relevant menu.

9.1 Animal list

In the animal list menu, you can list your calves in a table sorted by parameters. The table is sorted in ascending order by the first column of the first parameter. Parameters sorted in ascending order. This means that the calf with the greatest need for monitoring is at the very top of the table. The following parameters can be displayed:



- Feed consumption as a percentage
- Feed consumption in liters
- Drinking speed as a percentage
- Animal visits
- Breaks

		column 1	column 2		
1/118		cons.	dr.sp		
▶ 799	\A2	29	56	✓	✓+
744	fA1	29	✓	✓+	✓+
715	→A1	50	91	91	91
737	/A1	✓	56	✓+	74
742	fA1	✓	81	✓	✓+
743	→A1	✓	85	✓+	✓+
795	→D2	✓	✓	✓	✓

Note: You can also access the **animal list** directly via the  key.

Here is how you define which parameters are displayed in the two columns of the animal list:

1. Choose  > **Device data** to go to the **Animal list** submenu.

2. In **Column 1** or **Column 2**, choose   to select the parameter to be displayed in the respective column.

You call up an animal list as follows:

1. Choose  to go to the **Animal list** submenu.
2. In the top line, from left to right, you can check the following:

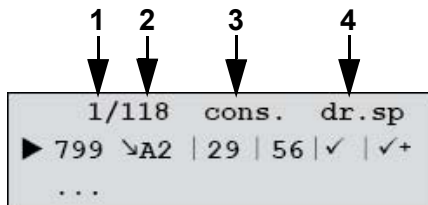

- The number of the calf you have selected in the list, counting from the top (1).
 - How many calves are registered (2).
 - The two parameters you have chosen (3 & 4).
3. You can view the following in the subsequent lines, from left to right:

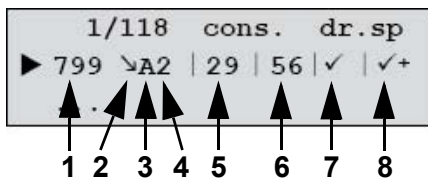

- The animal number (1).
- The plan tendency (2).
- The group to which the calf concerned has been assigned (3).
- The last feeding box visited (4).
- Parameter 1. The current value (today) is in the column on the left (5). Yesterday's value is in the column on the right (6).

Note: The parameter for feed consumption is simply today's value (consumption until present time) in liters with two decimal places.

- Parameter 2. The current value (today) is in the column on the left (7). Yesterday's value is in the column on the right (8).

Note: If there is a check mark instead of a number, then the value is 100%. A

check mark followed by a plus indicates a value greater than 100% (only for drinking speed and visits).

```

1/118 cons. dr.sp
▶ 799 >A2 | 29 | 56 | ✓ | ✓+
...

```

Example: The calf shown with the number 799 is in the weaning phase (reduced plan tendency), has been assigned to group A and has visited feeding box 2. At present, the calf has consumed only 29% of its feed entitlement, yesterday it was only 56%. The current value for drinking speed is 100% (✓); yesterday it was more than 100% (✓+).

4. By choosing , you can go to the detailed view for the currently marked animal. By choosing you can scroll to the other animals.

```

!< 3469>A1 ↗ 6.0 1
▶ cons. %: 25 100
break off: 1 0
speed. %: 85 100
visit: 3 6
C 1 %: 99 100
weight kg: 117 116
w. gain: 600 400
feed. day: 77

```

Note: In each line, by pressing , detailed information can be called up.

9.2 Entitlement

Here you can check your calves' feed entitlement.

You check feed entitlements as follows:

1. Choose to go to the **Entitlement** submenu.
2. From left to right in the top line, you can view the **animal number**, the **plan tendency** and the **feed quantity** scheduled for the current day (today) according to the plan.
3. Choose to select a calf.
4. Here you can check whether the selected calf is entitled to feed and the amount of feed to which it is still entitled.
 - **Variant 1:** The calf has a feed entitlement. In the **as of** menu, you can check the earliest time of day at which the calf has a feed entitlement and the feed quantity

saved by this time, for example **starting at 1:45 pm, 2.0 liters.**

- **Variant 2:** The calf has a feed entitlement, for example **starting 10:15 am, 0.0 liters or block.**
- **Variant 3:** The calf has saved more feed that it may consume at once and it consumed less than its maximum quantity during its last visit to the feeding box. You can check the latest time of day at which the calf can consume the difference between the consumed quantity and the maximum quantity, for example **up to 11:30 am, 1.5 liters.**

Note: You can delete the feed block by pressing . Confirm **Delete block?** by choosing .

5. In the **Cons. %** menu, you can check the percentage of feed that a calf has consumed today (left column) and yesterday (right column).
6. In the **Cons. L** menu, you can check the number of liters that a calf has consumed today (left column) and yesterday (right column).
7. In the **Break** menu, you can see how often a calf stopped feed consumption today (left column) and yesterday (right column). A calf interrupts feeding if it has consumed less than the quantity to which it is entitled per visit.
8. In the **Visit** menu, you can see how often a calf visited the feeding box today (left column) and yesterday (right column).
 - In the **Last** menu, you can check the time of day at which the calf last visited the feeding box.

You can view the last 10 visit times with entitlement and the consumption in liters by choosing .

- In the **With entitlement** menu, you can see how often a calf visited the feeding box today (left column) and yesterday (right column) with its feed entitlement.
- In the **Without entitlement** menu, you can see how often a calf visited the feeding box today (left column) and yesterday (right column) without a feed entitlement.







9.3 Alarm

You define limits for parameters that are used to monitor a calf's feed intake. If a calf exceeds or falls below these limits, an alarm will be triggered. You can define limits for the following parameters:

- Feed consumption as percentage of the daily amount.
- Number of feeding breaks.
- Drinking speed.

The procedure is described in detail in chapter **8.8 Alarm levels**, page **82**.

You check alarm animals as follows:

1. Choose  to go to the **Alarm** submenu.
A table will appear in the display.
 2. From left to right in the top line, you can view the **animal number**, the **plan tendency** and the **feed quantity** scheduled for the current day (today) according to the plan.
 3. Choose   to select a calf.
You will see the individual alarms.
 4. In the **Cons. %** menu, you can check feed consumption for today (left column) and yesterday (right column). Confirm **Cons. %** by choosing .
- You can view more detailed information about feed consumption for today (left column) and yesterday (right column). You can make changes in the submenus (Feed I and Cons. g/l)
- In the **Cons. %** menu, you can check the percentage of feed that a calf has consumed today (left column) and yesterday (right column).
 - In the **Cons. L** menu, you can view feed consumption for today (left column) and yesterday (right column) in liters
- Note:** If you want to set the consumed feed quantity for the current day to zero, press  and confirm **Delete consumption?** by choosing .
- In the **Feed L** menu, you can view and change the feed quantity to which the selected calf is entitled. The procedure is described in detail in chapter **8.5.2 Feed quantity**, page **73**.

- In the **Cons. g/l** menu, you can view and change the feed concentration to which the calf is entitled. The procedure is described in detail in chapter **8.5.3** Feed concentration, page **74**.
5. In the **Break** menu, you can view the number of feeding breaks for today (left column) and yesterday (right column).
- In the **with additive** menu, you can see how often the feed with additive has been broken off.
 - In the **without additive** menu, you can see how often the feed without additive has been broken off.
6. In the **Drnk spd.** menu, %, you can view the drinking speed for today (left column) and yesterday (right column). Confirm **Drnk spd. %** with .
- In the **relative %** menu, the drinking speeds for today (left value) and for yesterday (right value) are shown in percent.
 - In the **abs.l/min** menu, the absolute drinking speeds for today and yesterday are shown.

You delete alarms as follows:

- Choose to go to the **Alarm** submenu.
- Choose to select a calf.
- Confirm **delete all?** by choosing .



Note: You can only delete alarms from **yesterday**.

9.4 Plan over date



One day before an action with a time limit ends, such as an increase in the feed quantity, you will receive a plan over date message for this action. You will receive plan date messages:

- If a calf will not receive any more feed because the feeding plan is ending (**Feed plan**).
- If the concentration plan ends before the feeding plan. Your calves will receive the most recently fed concentration until the end of the feeding plan (**Concentration plan**).
- If deviation plans (**deviation**) for feed or concentration are ending. From this point onward, the affected calves are fed according to the feeding or concentration plan of their group.

You check plan over date messages as follows:





1. Choose  to go to the **Plan over** submenu.
A table will appear in the display.
2. From left to right in the top line, you can view the **animal number**, the **plan tendency** and the **feed quantity** scheduled for the current day (today) according to the plan.
3. Choose   to select a calf.
4. You will see the individual dates.

You delete plan over date messages as follows:

1. Choose  to go to the **Plan over** submenu.
 2. Confirm **delete all?** by choosing .
- The plan over date message disappears but will appear again for the next 3 days.



9.5 40FIT

In this menu, you can check how many and which of your calves are in a **40FIT period**.



1. Choose  to go to the **40FIT period** submenu.
A table will appear in the display.
2. From left to right in the top line, you can view the **animal number**, the **plan tendency** and the **feed quantity** scheduled for the current day (today) according to the plan.
3. Choose   to select the desired calf.
4. In the **Cons. %** menu, you can view feed consumption for today (left column) and yesterday (right column). Confirm **Cons. %** by choosing .
 - 4.1 A table will appear in the display.

In the top line, you can view the **animal number**, the **plan tendency** and the **feed entitlement** for the current day (today).
 - 4.2 In the 2nd line, you can check the feed entitlement in liters. Depending on the feed entitlement, one of the following 3 variants will appear:
 - **Variant 1:** The calf has a feed entitlement. In **as of**, you can check the earliest time of day at which the calf has a feed entitlement and the feed quantity saved by this time, for example **starting at 1:45 pm, 2.0 liters**.

- **Variant 2:** The calf has no feed entitlement, for example **starting at 10:15 am, 0.0 liters or block.**
- **Variant 3:** The calf has saved more feed that it may consume at once and it consumed less than its maximum quantity during its last visit to the feeding box. You can check the latest time of day at which the calf can consume the difference between the consumed quantity and the maximum quantity, for example **up to 11:30 am, 1.5 liters.**

Note: You can delete the feed block by pressing . Confirm **Delete block?** by choosing .

- 4.3 In **Cons. %**, you can view feed consumption for today (left column) and yesterday (right column) as a percentage.
- 4.4 In **Cons. L**, you can view feed consumption for today (left column) and yesterday (right column) in liters

Note: If you want to set the consumed feed quantity for the current day to zero, press  and confirm **Delete consumption?** by choosing .

- 4.5 In **Feed I**, you can view the feed quantity in liters to which the calf is entitled today (left column) and yesterday (right column) according to the feeding plan. Here you can change the duration and quantity of deviations in the feed quantity. The procedure is described in detail in chapter **8.5.2** Feed quantity, page **73**.
- 4.6 In **Cons. g/l**, you can view the feed concentration to which a calf is entitled today (left column) and yesterday (right column) according to the feeding plan. Here you can change the duration and quantity of deviations in the feed concentration. The procedure is described in detail in chapter **8.5.3** Feed concentration, page **74**.
5. In the **Break** menu, you can view the number of feeding breaks for today (left column) and yesterday (right column).
6. In the **Drnk spd. %** menu, you can view the drinking speed for today (left column) and yesterday (right column). You can view the relative (%) and the absolute drinking speed (l/min). Confirm **Drnk spd. %** by choosing .
- In the **Relative %** menu, you can view the relative drinking speed as a percentage for today (left column) and yesterday (right column).

- In the **abs. l/min** menu, you can view the absolute drinking speed in liters for today (left column) and yesterday (right column).
7. In the **Visit** menu, you can view the number of visits to the feeding box for today (left column) and yesterday (right column). You can differentiate between visits with and without feed entitlement. Confirm **Visit** by choosing .
- In the **Last** menu, you can view the time of day at which the selected calf last visited the feeding box today (left column) and yesterday (right column).
 - In the **With entitlement** menu, you can see how often a calf visited the feeding box today (left column) and yesterday (right column) with its feed entitlement.
 - In the **Without entitlement** menu, you can see how often a calf visited the feeding box today (left column) and yesterday (right column) without a feed entitlement.
8. In the **Feed. day** menu, you can view the feeding day the calf has reached according to the plan. You can review other detailed information in this menu. The procedure is described in detail in chapter **8.5.5** Shortening or lengthening total feeding duration, page **74**.

9.6 Marked

In this menu, you can view an overview of the drinking behavior of a calf that you have marked. You can also mark (see chapter **4.4** Hand terminal, page **30**) another calf that you specifically want to monitor.



You check marked animals as follows:

1. Choose to go to the **Marked** submenu.
A table will appear in the display.
 2. From left to right in the top line, you can check the **animal number**, the **plan tendency** and the **feed quantity** scheduled for the current day (today) according to the plan.
 3. Choose to select the desired calf.
 4. In the **Cons. %** menu, you can view feed consumption for today (left column) and yesterday (right column). Confirm **Cons. %** by choosing .
- 4.1 A table will appear in the display.

In the top line, you can view the **animal number**, the **plan tendency** and the **feed entitlement** for the current day (today).



4.2 In the 2nd line, you can check the feed entitlement in liters. Depending on the feed entitlement, one of the following 3 variants will appear:

- **Variante 1:** The calf has a feed entitlement. In the **as of** menu, you can check the earliest time of day at which the calf has a feed entitlement and the feed quantity saved by this time, for example **starting at 1:45 pm, 2.0 liters**.
- **Variante 2:** The calf has no feed entitlement, for example **starting at 10:15 am, 0.0 liters or block**.
- **Variante 3:** The calf has saved more feed that it may consume at once and it consumed less than its maximum quantity during its last visit to the feeding box. You can check the latest time of day at which the calf can consume the difference between the consumed quantity and the maximum quantity, for example **up to 11:30 am, 1.5 liters**.

Note: You can delete the feed block by pressing . Confirm **Delete block?** by choosing .



4.3 In the **Cons. %** menu, you can view feed consumption for today (left column) and yesterday (right column) as a percentage.

4.4 In the **Cons. L** menu, you can view feed consumption for today (left column) and yesterday (right column) in liters

Note: If you want to set the consumed feed quantity for the current day to zero, press  and confirm **Delete consumption?** by choosing .

4.5 In the **Feed I** menu, you can view the feed quantity in liters to which the calf is entitled today (left column) and yesterday (right column) according to the feeding plan. Here you can change the duration and quantity of deviations in the feed quantity. The procedure is described in detail in chapter **8.5.2** Feed quantity, page **73**.

4.6 In the **Cons. g/l** menu, you can view the feed concentration to which a calf is entitled today (left column) and yesterday (right column) according to the feeding plan. Here you can change the duration and quantity of deviations in the feed concentration. The procedure is described in detail in chapter **8.5.3** Feed concentration, page **74**.

5. In the **Break** menu, you can view the number of feeding breaks for today (left column) and yesterday (right column).
6. In **Drnk spd. %**, you can view the drinking speed for today (left column) and yesterday (right column). You can view the relative (%) and the absolute drinking speed (l/min). Confirm **Drnk spd. %** with 
 - In the **Relative %** menu, you can view the relative drinking speed as a percentage for today (left column) and yesterday (right column).
 - In the **abs. l/min** menu, you can view the absolute drinking speed in liters for today (left column) and yesterday (right column).
7. In the **Visit** menu, you can view the number of visits to the feeding box for today (left column) and yesterday (right column). You can differentiate between visits with and without feed entitlement. Confirm **Visit** by choosing 
 - In the **Last** menu, you can view the time of day at which the selected calf last visited the feeding box today (left column) and yesterday (right column).
 - In the **With entitlement** menu, you can see how often a calf visited the feeding box today (left column) and yesterday (right column) with its feed entitlement.
 - In the **Without entitlement** menu, you can see how often a calf visited the feeding box today (left column) and yesterday (right column) without a feed entitlement.
8. In the **Feed. day** menu, you can view the feeding day the calf has reached according to the plan. You can review other detailed information in this menu. The procedure is described in detail in chapter **8.5.5** Shortening or lengthening total feeding duration, page **74**.

9.7 New



The **New** menu is used to monitor newly registered calves. Calves displayed under **New** are registered and can consume feed.

You change the values of newly registered calves as follows:

1. Choose  to go to the **New** submenu.
2. In the **Animal no.** menu, you change the animal number.
3. In the **Group** menu, you register a calf in another group.

4. In the **Feed** menu, you define deviations in the dispensed feed quantity. The procedure is described in detail in chapter **8.5.2** Feed quantity, page **73**.
5. In the **Concentration** menu, you define deviations in the dispensed feed concentration. The procedure is described in detail in chapter **8.5.3** Feed concentration, page **74**.
6. In the **Weight** menu, you can view the initial weight.
7. In the **Plan day** menu, you can monitor the planned **feeding days**. Confirm **Plan day** by choosing .
 - In the **Feed. day** menu, you can check the number of days that have passed since the calf was registered.
 - In the **Correct. days** submenu, enter a negative value such as -2 to extend the total feeding duration by 2 days. Enter a positive value such as +2 to shorten the total feeding duration by 2 days.
 - In the **Plan day** menu, you can view the plan day that the calf will be on after your correction.
 - In the **Plan end** menu, you can view the number of days in which the end of the plan will be reached.
 - In the **Feed** menu, you check the assigned feed quantity.
 - In the **Concentration** menu, you can view the feed concentration that a selected calf will receive today.
 - In the **Initial** menu, you can view the calf's initial weight.
 - In the **Date** menu, you can view the calf's arrival date.
8. In the **Time** menu, you can view the registration time of a calf.
9. In the **Date** menu, you can view the registration date of a calf.

Proceed as follows to delete a calf from the list of newly registered calves:

- Choose  to go to the **New** submenu.
 - Confirm **Confirm?** by choosing .
- The calf will be deleted from the **New** menu.

Note: This only deletes calves from the **New** menu and not from the feed list. If you forget to confirm, the data will be automatically removed from the **New** menu after two days.

9.8 Double

During the fully automated registration process, it is possible for an animal number to be assigned twice. In the **Double** menu, you can modify the double animal numbers.

Proceed as follows to assign a new animal number to a calf that has been assigned a double animal number:

1. Choose  > **Double** to go to the **Animal no.** submenu.

The calf with the double animal no. will be shown in the top line of the table.

2. For the displayed calf, select an animal number that has not yet been assigned to a calf.

2.1 Confirm the selected calf by choosing .

2.2 Enter the animal number.

3. Confirm **Confirm?** by choosing .

The calf now has its own animal number.

9.9 Unknown

If you are running your automatic feeder with animal identification, the feeder registers all transmitters that approach it. In the **Unknown** menu, the following transmitters are registered:

- Transmitters that have not been assigned an animal number.
- Transmitters that have been assigned an animal number but that you have not yet registered for the automatic feeder and assigned to a feeding group.

Proceed as follows to check and register unknown transmitters:

1. Choose  to go to the **Unknown** submenu.

2. Use   to scroll through the list of unknown animal numbers.

3. In the **No.** menu, you can view the unknown animal number.

4. In the **Number** menu, you can see how many unknown transmitters have been identified and how often.

5. In the **Time** and **Date** menus, you can see when the animal identification function last identified the unknown transmitter.
6. In the **Register** menu, you register the calf with the unknown transmitter number for the automatic feeder. Confirm **Register?** by choosing .
- 6.1 In the **Group** menu, you choose to select a group.
- 6.2 In the **Correct. days** menu, you enter the number of days by which you want to move the calf in the plan.
- 6.3 Confirm **Register?** with .

The calf is registered.

You delete unknown transmitters as follows:

1. Choose to go to the **Unknown** submenu.
2. Confirm **Delete?** by choosing .

The unknown transmitter will be deleted.

9.10 All

Here you can obtain a full overview of the feeding behavior of all calves. You display this overview in the exact same way as described in the **marked** (see chapter 9.6 Marked, page 93) menu for a single calf. Use to scroll through the list of all registered calves.

9.11 Total consumption

In this menu, you can view the amount of feed your calves have consumed. You can display the consumption amounts of all calves, individual groups and individual calves as well as the number of quantity of portions dispensed until the present time.

9.11.1 Consumption of all calves



You display the consumption of all calves as follows:

1. Choose > **Animal control** > **Total consumption** to go to the **Total** submenu.
The planned consumption amounts are displayed in the left-hand column (**Set**) and in the right-hand column (**Actual**) the actual consumption amounts of all calves for today, yesterday and the day before yesterday.
2. Use to scroll through the list of displayable feed parameters.

3. In the **MP** menu, you can view the amount of milk powder (MP) in kilograms that your calves have consumed today (**t.kg**), yesterday (**y.kg**) and the day before yesterday (**b.kg**).

9.11.2 Consumption of individual calves

You display the consumption of all calves as follows:

1. Choose  > **Animal control** > **Total consumption** to go to the **Animal** submenu.
A table is displayed that shows the feed consumption of the selected calf over the entire feeding period.
2. From left to right in the top line, you can check the **animal number**, the **plan tendency** and the **feed quantity** scheduled for the current day (today) according to the plan.
3. Choose   to select a calf.
4. In the **MP** menu, you can view the amount of milk powder (MP) in kilograms that the selected calf has consumed to date.



9.11.3 Prepared feed portions

You display the prepared feed portions of all calves as follows:

1. Choose  > **Animal control** > **Total consumption** to go to the **Portion** submenu.
2. In the **Number** menu, you can view all prepared feed portions to date.
3. In the **Quantity** menu, you can view the number of liters of feed prepared.

9.11.4 Consumption of a group



You display the consumption of all calves in a group as follows:

1. Choose  > **Animal control** > **Total consumption** to go to the **Group** submenu.
The left-hand column (**today**) shows the quantity of feed consumed today and the right-hand column shows the quantity consumed yesterday (**yest.**) in liters.
2. Use   to scroll through the list of displayable groups.
3. In the **quantity** menu, you can view the amount of feed in liters that calves in the selected group have consumed today and yesterday.

9.12 Print

Here you can print out the animal list or the alarm list. To do this, your automatic feeder must be connected to a printer.

To print:



1. Choose  > **Print** to go to the **Alarm list** or **Animal list** submenu.
 2. Confirm **Print alarm list?** or **Print animal list?** by choosing .
- The selected list will be printed.

9.13 Searching for animals

In the menus for animal control, you can search for specific calves, such as calves that you have marked. Marked calves are indicated by an asterisk (*) to the left of the animal number. You can also  mark (see chapter 4.4 Hand terminal, page 30) another calf that you specifically want to monitor.

You search for a specific calf as follows:

1. Press .

The animal control menus are displayed.
2. Go to the desired submenu.
3. Search for the calf. You can search for a calf in two ways:
 - Use   to scroll through the list of calves registered for the automatic feeder until you find the calf.
 - Press  and enter the number of the calf in the flashing field. The display will go directly to this calf.

If the animal number has not been assigned, the message **No such animal no.** will appear.

If the animal number has been assigned, but the calf has not been recorded in the selected menu, the message **Animal is not entitled** appears, for example in the Entitled menu.

Note: You can use the search function  in all other menus, for example when you register calves.

10 Care and maintenance

This chapter covers regular maintenance and functional testing of the automatic feeder, and to a certain extent, its accessories. These ensure that the required hygienic standards are maintained. Maintenance includes additional measures to preserve hygiene that are not described in the cleaning chapter, as well as scheduled replacement of wearing parts. Visual and functional testing of components as well as replacement of the suction hose and teat can be carried out by the owner/operator.

Note: Repair work and the replacement of wearing parts on or in the automatic feeder, with the exception of the suction hoses and teats, may only be carried out by a service technician.

On a regular basis, you must visually inspect and test the functions of the automatic feeder and its components, clean it to maintain hygiene, calibrate it and replace simple wearing parts such as the suction hose. Depending on the automatic feeder component in question, and depending how you run your automatic feeder, you must perform inspections and maintenance on a weekly, quarterly and annual basis.

At different intervals, service messages such as RS1 (regular service 1) will appear on the display of your automatic feeder. Contact your dealer and specify the service message you have received so that the dealer can perform the necessary maintenance.

Compliance with these maintenance intervals is the only way to ensure the long life and reliability of your automatic feeder.

The following regular services (RS) have been defined:

- RS1 must be performed every 4 months.
- RS2 must be performed every 12 months.
- RS3 must be performed every 36 months.

Note: For a quicker overview, see the care and maintenance schedule in the appendix (see **13.5.2** Maintenance intervals and activities on page **131**).

⚠ DANGER Beware of **lethal electric shock**. The electrical components of the automatic feeder are live. Before working on components, always turn off the automatic feeder with the main switch and disconnect the power plug.

⚠ WARNING Beware of injuries due to automatic start-up. Do not reach into the hazardous area of the mixer and the powder mixing unit. The mixer or powder mixing unit can start up automatically at any time, crushing or cutting off your hand and fingers. Before reaching into the hazardous area of the mixer or powder mixing unit, always turn off the automatic feeder using the main switch and disconnect the power plug.

10.1 Daily care and maintenance tasks

Perform the following inspections on a daily basis:

- Check the safety devices of the automatic feeder for visible damage. Are the warning signs still legible? Immediately replace any warning signs that are difficult to read or damaged. New warning signs are available from Förster-Technik GmbH.
- Check the automatic feeder and its power and water lines for visible damage. You may not run the automatic feeder if power or water lines are damaged. In the event of damage, turn off the automatic feeder using the main switch and disconnect the power plug. Contact your service technician immediately. All repairs must always be performed by a service technician.
- Check the intensive mixer for visible damage.
 - Are the electrodes, temperature sensors and mixer blades damaged? Damaged parts must be immediately replaced by a service technician.
 - Are the mixer blades working? Damaged parts must be immediately replaced by a service technician.
 - Is the mixer housing leaking? A leaky housing must be immediately replaced by a service technician.
 - Is the mixer screen clogged? A clogged screen must be immediately cleaned by a service technician.
- Check the teats and suction hoses for the following:
 - **Leaks and wear.** Immediately replace damaged or leaky teats and hoses. Leaky hoses draw in air, and this impairs the functioning of the automatic feeder. As a result, your calves could receive insufficiently concentrated feed and would not be supplied with any or sufficient feed. This can lead to malnutrition, which can cause impaired

growth and development, increased susceptibility to illness or even the death of your calves. You can obtain new hoses and teats from your dealer.

- **Cleanliness.** Clean dirty hoses as described in chapter **6.3.3** Cleaning cycle, page **51**.
- **⚠ WARNING** There is a **risk of injury** due to automatic start-up. Do not reach into the hazardous area of the mixer and the powder discharge opening. The mixer and powder discharge opening can start up automatically at any time, crushing or cutting off your hand and fingers. Turn off the automatic feeder with the main switch and disconnect the power plug. Only use the supplied scraper to clean the powder discharge opening.
Check the powder discharge opening for foreign objects and only use the supplied scraper to remove them. Foreign objects can damage the mixer and the automatic feeder. Foreign objects that enter the feed can injure your calves. (See chapter **6.3.6** Cleaning the powder discharge opening, page **54**).
Check the powder discharge opening for milk deposits and only use the supplied scraper to remove them. (See chapter **6.3.6** Cleaning the powder discharge opening, page **54**). Milk deposits can cause the milk powder to be incorrectly dispensed. As a result, your calves could receive insufficiently concentrated feed and would not be supplied with any or sufficient feed. This can lead to malnutrition, which can cause impaired growth and development, increased susceptibility to illness or even the death of your calves.
- Check the detergent pump with detergent lance for visible damages.
 - Are the hoses on the pressure and suction side tight? Let a service technician immediately replace the damaged hoses.
 - Is the detergent lance damaged, clogged, incrustated or worn? Clean the detergent lance and a service technician immediately replace the damaged pieces.
 - Is the sieve at the bottom of the detergent lance clogged? Clean the detergent lance.
 - Are all elements (lid of the detergent container, hose connection of the detergent lance, hose connections of the pump) properly closed? Close them properly.
- If necessary, check the level of the detergent container and fill up the cleaning agent.

10.2 Care and maintenance tasks required every 4 months

To ensure that your automatic feeder can mix the individual liquid and powder feed components (water and milk substitute (MP) in the proper ratio, it must be recalibrated no later than every 4 months or after each new delivery of milk substitute. If you have not concluded a maintenance agreement for this service, you must recalibrate the feeder yourself. This is the only way to ensure that your calves receive a sufficient amount of properly mixed feed.

ATTENTION If you do not recalibrate your automatic feeder on a regular basis, your calves will receive insufficient or improperly mixed feed. This will cause malnutrition. Malnutrition can cause impaired growth and development, increased susceptibility to illness or even the death of your calves.

The first calibration is performed by your service technician during commissioning.

You must manually recalibrate powder and liquid feed and cleaning agents because the actual quantity will deviate from the set quantity for various reasons, such as fluctuations in water pressure.

Calibration involves several steps:

- The volume of liquid components (water and detergent) is determined.
- The weight of the powder components (milk substitute, additives) is determined.

10.2.1 Manually calibrating liquid and powder components

If your automatic feeder does not have an **automatic calibration scale**, you must provide the following items for the calibration:

- 1 graduated cylinder with gradations in ml (approximately 1 liter capacity).
- 1 scale (weighing accuracy of 1 g).
- 1 container to collect milk substitute.

10.2.1.1 Calibrating without a calibration scale

You determine the actual value using a scale and a graduated cylinder and the program will prompt you to enter this value using the number keys.

Proceed as follows to calibrate powder components without a calibration scale:

1. Choose  > **Calibration** to go to the **Components** submenu.

2. In the **MP** menu, you recalibrate the milk substitute.

- Confirm **MP** by choosing .
- **Set quantity** shows the amount of milk substitute (MP) to be dispensed by the automatic feeder.
- **Runtime** shows the time in which the automatic feeder should dispense the milk powder.
- **Date** shows when MP was last calibrated.
- Tilt the empty mixer forward.
- Hold the container for the milk substitute under the powder discharge.
- Confirm **Start?** by choosing .
- Confirm **Exit automatic mode?** by choosing . This message will only be displayed if your automatic feeder is still in automatic mode.



Powder will be dispensed.

- Place the container with the collected milk substitute on the scale.
- In the **Actual** menu, enter the weight displayed on the scale.
- Confirm **Confirm value....** by choosing .
- **Date** now shows the current date.
- Repeat the calibration to check your results.

3. Calibrate other **powder components** using the same method.

Proceed as follows to calibrate liquid components without a calibration scale:

1. Choose  > **Calibration** to go to the **Components** submenu.
2. In the **Water** menu, you recalibrate water.
 - Confirm **Water** by choosing .
 - **Set quantity** shows the amount of water that the automatic feeder should dispense.
 - **Runtime** shows the time in which the automatic feeder should dispense the water.

- **Date** shows when the water was last calibrated.
- Confirm **Start?** by choosing .
- Confirm **Exit automatic mode?** by choosing . This message will only be displayed if your automatic feeder is still in automatic mode.

Water will be dispensed into the mixer.





- Tilt the mixer so that the water flows into the graduated cylinder. Measure the collected water in milliliters.
- In the **Actual** menu, enter this measured quantity using the number keys.
- Confirm **Confirm value....** by choosing .
- **Date** now shows the current date.
- Repeat the calibration to check your results.

3. Calibrate other **liquid components** using the same method.

10.2.1.2 Calibrating using the calibration scale

The automatic feeder determines the actual value using the built-in automatic calibration scale (additional equipment).

Proceed as follows to calibrate liquid components using the calibration scale:

1. Choose  > **Calibration** to go to the **Components** submenu
2. In **Water**, you calibrate water.
 - Confirm **Water** by choosing .
 - **Set quantity** shows the amount of water that the automatic feeder should dispense.
 - **Runtime** shows the time in which the automatic feeder should dispense water.
 - **Date** shows when the water was last calibrated.
 - Confirm **Start?** by choosing . The calibration procedure will start. The set value of 500 ml will be shown first in the display.
 - Confirm **Exit automatic mode?** by choosing . This message will only be displayed if your automatic feeder is still in automatic mode.

played if your automatic feeder is still in automatic mode.

The device now carries out two check weighings without the user having to do anything and shows the result.

- Then the average value of these two control weighings is shown flashing in the **displayed** line. Confirm the **Confirm value....** prompt by choosing . You then return to the calibration menu.
 - **Date** now shows the current date.
3. Repeat the calibration to check your results.
 4. Calibrate other **liquid components** using the same method.

Proceed as follows to calibrate powder components using the calibration scale:





1. Choose  > **Calibration** to go to the **Components** submenu.
2. In **MP**, you calibrate the milk substitute.
 - Confirm **MP** by choosing .
 - **Set quantity** shows the amount of MP that the automatic feeder should dispense.
 - **Runtime** shows the time in which the automatic feeder should dispense the MP.
 - **Date** shows when MP was last calibrated.
 - Confirm **Start?** by choosing .
 - Confirm **Exit automatic mode?** by choosing . This message will only be displayed if your automatic feeder is still in automatic mode.
 - Place the calibration box into the mixer jar and confirm the prompt **Calibration box used?** by choosing .

The device now carries out two check weighings without the user having to do anything and shows the result.

- Then the average value of these two control weighings is shown flashing in the **displayed** line. Confirm the **Confirm value....** prompt by choosing . You then return to the calibration menu.
- **Date** now shows the current date.

- Remove the calibration beaker from the mixer jar.
 - Repeat the calibration to check your results.
3. Calibrate other **powder components** using the same method.

Proceed as follows to calibrate the detergent using the calibration scale:

1. Choose  > **Calibration** to go to the **Components** submenu.
2. In the **Detergent** menu, you recalibrate the cleaning agent.
 - Confirm **Detergent** by choosing .
 - **Set quantity** shows the amount of cleaning agent that the automatic feeder should dispense.
 - **Runtime** shows the time in which the automatic feeder should dispense the cleaning agent.
 - **Date** shows when the cleaning agent was last calibrated.
 - Confirm **Start?** by choosing .
 - Confirm **Exit automatic mode?** by choosing . This message will only be displayed if your automatic feeder is still in automatic mode.
 - Place the calibration box into the mixer jar and confirm the prompt **Calibration box used?** by choosing .

Detergent will be dispensed into the calibration beaker.

- The device now carries out two check weighings without the user having to do anything and shows the result.
- Then the average value of these two control weighings is shown flashing in the **displayed** line. Confirm the **Confirm value....** prompt by choosing . You then return to the calibration menu.
- **Date** now shows the current date.
- Remove the calibration beaker from the mixer jar.
- Repeat the calibration to check your results.

10.2.2 Replacing hoses and teats

- Replace all hoses that carry feed from the mixer to the feeding stations. This reduces the risk of infection. New hoses are available from your dealer.
- Replace all teats. This reduces the risk of infection. New teats are available from your dealer.

10.3 Annual care and maintenance tasks

- Perform a visual functional check of the powder mixer unit. The powder mixer unit may only be repaired by your service technician.

11 Faults and warnings

When an error occurs while the automatic feeder is running, the Auto LED on the hand terminal will flash. The error is described in fault or warning messages displayed on your automatic feeder.

You must immediately rectify errors that occur during operation. Unresolved errors, for example during preparation of feed, could cause your calves to suffer from malnutrition.

ATTENTION An interruption in feeding operation means that your calves will not receive any feed. This can lead to malnutrition. Malnutrition can cause impaired growth and development, increased susceptibility to illness or even the death of your calves. You must use an alternative method to supply your calves with feed as long as the automatic feeder is out of service.

You can fix some faults yourself. Errors that only a service technician can eliminate are indicated as such.

11.1 Faults

In the event of a **fault**, automatic mode is interrupted and no feed is prepared. Respond immediately to the fault and ensure that your calves are supplied with feed using an alternative method as long as the automatic feeder is out of service.

ATTENTION An interruption in feeding operation means that your calves will not receive any feed. This can lead to malnutrition. Malnutrition can cause impaired growth and development, increased susceptibility to illness or even the death of your calves. You must use an alternative method to supply your calves with feed as long as the automatic feeder is out of service.

11.1.1 Heating

Heating fault xx.x °C will be shown in your display when the boiler water's temperature is too low. Feeder operation will be interrupted.

ATTENTION An interruption in feeding operation means that your calves will not receive any feed. This can lead to malnutrition. Malnutrition can cause impaired growth and development, increased susceptibility to illness or even the death of your calves. You must use an alternative method to supply your calves with feed as long as the automatic feeder is out of service.

You correct the fault as follows:

1. Check whether your calves are consuming feed so quickly that the boiler does not have enough time to heat up the water.
2. Check the temperature of the portion and, if necessary, reduce it via  > **Device data** > **Portion**.

If the fault appears again, you must contact a service technician immediately.

11.1.2 Temperature too high

Fault, temperature too high will appear in your display if the boiler water's temperature is too high. Feeder operation will be interrupted until the water in the boiler has cooled to the set maximum temperature. Provide your calves with feed using an alternative method as long as feed operation is interrupted.

ATTENTION An interruption in feeding operation means that your calves will not receive any feed. This can lead to malnutrition. Malnutrition can cause impaired growth and development, increased susceptibility to illness or even the death of your calves. You must use an alternative method to supply your calves with feed as long as the automatic feeder is out of service.

You correct the fault as follows:

1. Confirm **Fault, temperature too high** by choosing .
2. In **Boiler water start?**, press & hold .
3. Drain water from the boiler into the mixer jar until the fault message disappears.
4. Confirm **Mixer: empty?** by choosing .

Check the temperature of the supplied water if the Boiler is supplied with preheated water.

If the fault appears again:

- Check the temperature of the inflowing water and reduce it, if necessary. This is especially necessary if you supply the Boiler with preheated water.
- If this fault persists, you must contact your service technician immediately.

11.1.3 Boiler not filled

When you turn on the automatic feeder, the control unit checks whether the boiler is filled with water. If it is not filled, feeder operation will be interrupted and the message **Fault, boiler not filled** will appear in your display.

ATTENTION An interruption in feeding operation means that your calves will not receive any feed. This can lead to malnutrition. Malnutrition can cause impaired growth and development, increased susceptibility to illness or even the death of your calves. You must use an alternative method to supply your calves with feed as long as the automatic feeder is out of service.

You correct the fault as follows:

1. Confirm **Fault, boiler not filled** by choosing .
2. Check the water supply.
3. In **Fill boiler ?**, press .
4. Check whether the water jet hits the rod electrode.

If this fault persists, you must contact your service technician immediately.

11.1.4 Water shortage

If the rod electrode is not grounded in the mixer jar when water is being added and the water meter sends no pulse, a water test will be started. If the water test is not successful, then feed preparation and animal identification will be switched off. **Fault, water shortage** appears in the display.

ATTENTION An interruption in feeding operation means that your calves will not receive any feed. This can lead to malnutrition. Malnutrition can cause impaired growth and development, increased susceptibility to illness or even the death of your calves. You must use an alternative method to supply your calves with feed as long as the automatic feeder is out of service.

You correct the fault as follows:

1. Confirm **Fault, water shortage** by choosing .
2. Confirm **Bo. water start?** by choosing .
3. Check whether the water jet hits the rod or point electrode.
4. Check the water supply to the automatic feeder.

5. Check whether deposits such as calcium have formed on the electrode.
6. Confirm **Delete fault?** with if you have fixed the fault.

If this fault persists, you must contact your service technician immediately.

11.1.5 Water meter

You can continue feeder operation temporarily in emergency mode.

You start emergency mode as follows:

1. Confirm **Fault, water meter** by choosing .
2. Confirm **Start boiler water?** with and check whether pulses are displayed.
3. Confirm **Mixer emptying?** by choosing .
4. Confirm **Delete fault?** by choosing .
5. Confirm **emergency mode start?** by choosing .
6. **Warning, water meter** will appear in the display.
The calibration values for the water boiler become invalid.
7. The fault message **Calibration** will appear.
8. Calibrate the **Boiler water**.
The automatic feeder is now operating in emergency mode.

After repairing the water meter, delete the **water meter warning** and return to normal mode.

You return to normal mode as follows:

1. Confirm **Warning, water meter** by choosing .
- The **Delete warning** message will appear.
2. Confirm **Delete warning** with if you have fixed the fault.
You will see the fault message **Calibr. Bo. water**
3. Calibrate the **Boiler water** as described in chapter **10.2.1** Manually calibrating liquid and powder components, page **104**.
4. Press until the message **Start automatic mode?** appears in the display.
5. Confirm **Start automatic mode?** by choosing .

The automatic feeder will now operate in normal mode again.

11.1.6 Mixer emptying

The fault message **Mixer emptying** will appear if the rinsing water in the mixer cannot be drained. Feeder operation will be interrupted.

ATTENTION An interruption in feeding operation means that your calves will not receive any feed. This can lead to malnutrition. Malnutrition can cause impaired growth and development, increased susceptibility to illness or even the death of your calves. You must use an alternative method to supply your calves with feed as long as the automatic feeder is out of service.

You correct the fault as follows:

⚠ DANGER **Beware of lethal electric shock.** The electrical components of the automatic feeder are live. Before working on components, always turn off the automatic feeder with the main switch and disconnect the power plug.

1. Turn off the automatic feeder using the main switch and disconnect the power plug.
2. Check all components carrying feed from the mixer to the mixer drain valve or from the mixer up to the teat for blockages and remove them.

ATTENTION The hose from the mixer drain valve to the drain channel may not be lengthened.

3. Reinsert the power plug and turn on the automatic feeder using the main switch.

4. Confirm **Fault, mixer emptying** by choosing .

5. Check the feeding pump:

- 5.1 Confirm **Start feeding pump?** by choosing .

6. Check the mixer drain valve:

- 6.1 Confirm **Open mixer drain?** by choosing .

7. Check the rod electrode.

- 7.1 Confirm **Bo. water start?** by choosing to fill the mixer with water.

- 7.2 In the **Mixer emptying?** menu, confirm by choosing .

8. Confirm **delete fault?** by choosing if you have fixed the fault.

9. Remove detergent remnants from components carrying feed by rinsing them with water.

ATTENTION Detergent remnants that enter the feed can be hazardous to the health of calves. Remove detergent remnants before recommissioning the automatic feeder.

10. Return to automatic mode.

11.1.7 Heating

If **Failure, heating** appears in your display, contact a service technician immediately. Feeder operation will be interrupted.

ATTENTION An interruption in feeding operation means that your calves will not receive any feed. This can lead to malnutrition. Malnutrition can cause impaired growth and development, increased susceptibility to illness or even the death of your calves. You must use an alternative method to supply your calves with feed as long as the automatic feeder is out of service.

11.1.8 Boiler temperature sensor

If **Boiler temp. sensor fault** appears in your display, contact a service technician immediately. Feeder operation will be interrupted.

ATTENTION An interruption in feeding operation means that your calves will not receive any feed. This can lead to malnutrition. Malnutrition can cause impaired growth and development, increased susceptibility to illness or even the death of your calves. You must use an alternative method to supply your calves with feed as long as the automatic feeder is out of service.

11.1.9 Calibration

Calibration fault will be shown in your display if the liquid or powder feed components and the detergent have not been calibrated. The automatic feeder will not switch to automatic mode until you have calibrated these components. Feeder operation will be interrupted.

ATTENTION An interruption in feeding operation means that your calves will not receive any feed. This can lead to malnutrition. Malnutrition can cause impaired growth and development, increased susceptibility to illness or even the death of your calves. You must use an alternative method to supply your calves with feed as long as the automatic feeder is out of service.

You correct the fault as follows:

Calibrate the liquid and powder feed components as well as the detergent (see chapter **10.2.1** Manually calibrating liquid and powder components, page **104**).

If this fault persists after calibration, you must contact your service technician immediately.

11.1.10 Station/drain valve

Station/drain valve fault will be shown in your display if a feeding box valve or the mixer drain valve is leaking. The automatic feeder loses water during cleaning. Feeder operation will be interrupted.

ATTENTION An interruption in feeding operation means that your calves will not receive any feed. This can lead to malnutrition. Malnutrition can cause impaired growth and development, increased susceptibility to illness or even the death of your calves. You must use an alternative method to supply your calves with feed as long as the automatic feeder is out of service.

You must contact a service technician immediately.

11.1.11 Uncontrolled output

You will see **Fault, uncontrolled output** in your display if a fault occurs while dispensing water, milk powder or detergent. Feeder operation will be interrupted.

ATTENTION An interruption in feeding operation means that your calves will not receive any feed. This can lead to malnutrition. Malnutrition can cause impaired growth and development, increased susceptibility to illness or even the death of your calves. You must use an alternative method to supply your calves with feed as long as the automatic feeder is out of service.

You correct the fault as follows:

Turn off the automatic feeder using the main switch and turn it on again after a few seconds.

If this fault message appears again, you must contact your service technician immediately.

Notify the technician of the messages shown in the display.

11.2 Warnings

In the case of a **warning**, automatic mode will not be interrupted, and feeder operation continues.

11.2.1 Identification

Identification warning will appear in your display if animal identification is not working.

You must contact a service technician immediately.

11.2.2 Mixer emptying

Mixer emptying warning appears if the mixer cannot be drained. For example, this can be because the drain is clogged or the feeding pump is no longer running.

⚠ DANGER Lethal electric shock. The electrical components of the automatic feeder are live. Before working on components, always turn off the automatic feeder with the main switch and disconnect the power plug.

You correct the fault as follows:

1. Check all components carrying feed from the mixer to the mixer drain valve or from the mixer up to the teat for clogs and remove them.

ATTENTION The hose which goes from the mixer drain valve to the drain channel must not be lengthened.

2. Check the feeding pump.

3. Check the mixer drain valve.

3.1 Confirm **Mixer emptying warning** by choosing .

3.2 Confirm **Feeding pump: start?** by choosing .

The pump is actuated.

3.3 Confirm the **Mixer emptying warning** by choosing .

3.4 Confirm **Mixer drain: open?** by choosing .

The mixer will be pumped empty.

4. Check the rod electrode.

4.1 Visually check the rod electrode for deposits.

5. Fill and drain the mixer.

5.1 Confirm the **Mixer emptying warning** by choosing .

5.2 Confirm **Bo. water start?** by choosing .

The mixer will fill up with water.

5.3 Confirm **Mixer: empty** by choosing .

The mixer will be drained.

If the fault has been fixed, confirm the message **Delete warning?** in the display with .

If this does not correct the fault, you must contact a service technician immediately.

11.2.3 Mixer temperature sensor

The **Mixer temp. sensor warning** will be shown in the display if the temperature sensor in the mixer jar is faulty or the temperature of the mixed feed in the mixer jar drops below 0 °C.

You must contact a service technician immediately.

11.2.4 Unknown transmitters

The **Unknown transmitters warning** appears in your display:

- If a transmitter is detected by the identification unit for which no animal number has been assigned.
- If a transmitter number has been allocated to an animal number, but has still not been registered.

You correct the fault as follows:

1. Confirm **Unknown transmitters warning** by choosing .
2. In the **No.** menu, you check the unknown transmitter number.
3. In the **Number** menu, you check how often the unknown transmitter number has been identified.
4. In the **Time** menu, you check when the transmitter was last registered by the identification system.
5. Confirm **delete?** by choosing if you want to delete the transmitter number.
6. Confirm **Register** by choosing if you want to allocate the unknown transmitter number to an animal number.

11.2.5 Calibration

The **calibration warning** will appear in your display if the last calibration was 120 days ago or if automatic calibration failed. You will see which components you have to calibrate.

You correct the fault as follows:

1. Calibrate all components shown in the display as described in chapter **10.2.1** Manually calibrating liquid and powder components, page **104**.
2. Confirm **delete warning?** by choosing .

Note: If you delete the warning without calibrating, the message will appear again the next day.

11.2.6 Calibration scale

The **calibration scale warning** will appear in your display if your calibration scale is not working.

You must contact a service technician immediately.

ATTENTION There is a risk of malnutrition caused by incorrectly dispensed feed portions. Malnutrition can cause impaired growth and development, increased susceptibility to illness or even the death of your calves. You must ensure that you provide your calves with feed using an alternative method as long as the calibration scale is not working.

11.2.7 ID chip

The automatic feeder is equipped with an electronic name plate (ID chip) upon which the device number and other important information for the operation of the automatic feeder is stored.

The **warning ID chip still xx days** will appear in your display if the ID chip is defective. You must contact a service technician immediately.

ATTENTION An interruption in feeding operation means that your calves will not receive any feed. This can lead to malnutrition. Malnutrition can cause impaired growth and development, increased susceptibility to illness or even the death of your calves. You must use an alternative method to supply your calves with feed as long as the automatic feeder is out of service.

11.2.8 Double animal number

Warning, double animal no. will appear in your display if the same number was assigned twice during the fully automated registration process.

You change the double animal number as follows:

1. Confirm **Double animal no. warning** with

The **Double** menu in Animal control will appear (see chapter 9.8 Double, page 97)

2. In **No.**, you can view the full unknown transmitter number of the double calf.
3. In **Animal no.**, change the automatically assigned number.
4. In **Time** and **Date**, check when the double animal number appeared.
5. Once you have changed the animal number, confirm **confirm?** by choosing .

Note: Only when you have changed the animal number will your confirmation take effect and the warning be deleted.

11.2.9 Machine capacity

Warning, Machine capacity will appear when there is no more storage space available for animal numbers or transmitter numbers.

Confirm **Machine capacity** by choosing in order to view detailed information.

- **only 250 animals poss.** means: No more free animal numbers are available.
- **Transmitter storage full** means: No more storage space available for further transmitter numbers.

You rectify the warning "only 250 animals poss." as follows:

1. Cancel one or more animals in the **Animal** (see chapter 9 Animal control, page 85) menu.

ATTENTION If you cancel an animal's registration it will not receive any feed. This can lead to malnutrition. Malnutrition can cause impaired growth and development, increased susceptibility to illness or even the death of your calves. You must use an alternative method to supply your calves with feed.

2. Confirm **delete warning?** by choosing .

You rectify the "transmitter storage full" error as follows:

1. Choose  > **Animal management > Transmitters** to go to the **Edit** submenu.
2. Select the transmitter number to be deleted and confirm **Delete** by choosing .

Note: You can only delete transmitter numbers of calves that are not registered (= status: available).

3. Confirm **delete warning?** by choosing .

11.2.10 Check SD card

The **Check SD card** warning appears in your display:

- If data is to be saved manually, but no SD card is present.
- If data is to be saved manually, but the SD card is currently write-protected.
- If data is to be saved automatically but the SD card is full.
- If data is to be saved automatically but the SD card is currently write-protected.

11.3 Other faults and messages

11.3.1 Automatic feeder

11.3.1.1 Starting program

The message **Smart Vxx.xx starting program** appears when the control program of the automatic feeder starts.

Wait until the automatic feeder is ready to operate.

11.3.1.2 Initialization of the feeder

The message **first startup, press enter to start installation** will appear in the display in the following cases:

- When the automatic feeder starts for the first time.
- If the computer card must be replaced due to a hardware defect.

Follow the instructions on the screen. The following steps can be performed in the course of the initialization:

- > Restoration of the last backup (if available).
- > Entry of the language for the user interface.
- > Entry of the current date and time.

11.3.2 Hand terminal

11.3.2.1 CAN bus off

If a short circuit or electromagnetic discharges negatively affect the CAN cable, the message **terminal xx.xx CAN bus off** will appear in the display.

You must contact a service technician immediately.

11.3.2.2 CAN bus heavy

The following faults trigger the message **terminal Vxx.xx CAN bus heavy** :

- Short circuit.
- Terminating resistor not set.
- Break in the data line.
- CAN cable incorrectly attached.
- No connection for automatic feeder control unit.

You must contact a service technician immediately.

11.3.2.3 Waiting

The following faults prevent the hand terminal from initializing:

- The CAN bus address of the terminal is not the same as the one defined in setup of the of the automatic feeder.
- The feeder control unit is not active.

The message **terminal Vxx.xx waiting** appears.

You eliminate the faults as follows:

1. Start search mode: Press when you switch on the feeder and keep this key pressed.
2. If this message appears again, you must contact your service technician immediately.

11.3.2.4 Searching



When the hand terminal is in search mode, the message **terminal Vxx.xx searching** will appear.

You must contact a service technician immediately.

11.3.3 Bootloader

11.3.3.1 Waiting for update

The following faults trigger the message **bootloader Vxx.xx waiting for update**:

- The automatic feeder's control program is not able to run.
Update the program using an SD card or FlashManagerPlus.
- The bootloader was (accidentally) activated while switching on.
If the bootloader was accidentally started during the start of the automatic feeder by pressing and holding  , you have to restart the automatic feeder.

11.3.3.2 Flash programming

The message **bootloader Vxx.xx flash programming** will appear while the program is being updated.

Wait until the update has been completed.

11.3.3.3 Starting program

The message **bootloader Vxx.xx starting program** will appear when the bootloader for the automatic feeder starts.

Wait until the program has started.

11.4 Service messages

A service message appears in the automatic feeder's display every 4 months. This shows which maintenance (regular service) must be done by your service technician. Compliance with these maintenance intervals is the only way to ensure the long life and reliability of your automatic feeder. Please notify your service technician when the service message appears on the display.

The following regular services (RS) have been defined:

- RS1 must be performed every 4 months.
- RS2 must be performed every 12 months.
- RS3 must be performed every 36 months.

12 Disposal

All automatic feeder components, liquids and solids must be disposed of in compliance with the applicable official regulations for proper waste recycling and disposal in your country. If you are not certain which regulations apply to you, ask your service technician and use the Internet or the yellow pages to find out which government agency is responsible for your jurisdiction. Contact the appropriate authorities and find out which regulations apply to you.

Always observe the safety data sheets supplied with some components, liquids and solids.

Before you dispose of the automatic feeder, you must shut it down.

12.1 Disposing of residual cleaning agent

Dispose of any residual cleaning agent. See the cleaning agent manufacturer's technical data sheet for more information on the disposal of the cleaning agent.

⚠ WARNING Beware of **Chemical burns** from cleaning agents. The cleaning agent can cause chemical burns to your eyes or hands. Always wear goggles and chemical-proof protective gloves when disposing of cleaning agents. Follow all the safety instructions listed in the safety data sheet for the cleaning agent and wear the specified safety equipment.

12.2 Disposing of hoses

Dispose of hoses as controlled waste or municipal waste, depending on the material. Read the disposal instructions on the packaging of the hoses, or contact your waste disposal center for instructions.

12.3 Disposing of cables

Dispose of cables as controlled waste or municipal waste, depending on the material. Read the disposal instructions on the packaging of the cables, or contact your waste disposal center for instructions.

12.4 Disposing of the hand terminal

Remove the cable that connects the hand terminal to the automatic feeder. The hand terminal contains electronic components and must therefore be disposed of as controlled waste. Ask your waste disposal company where you can dispose of electronic waste.

12.5 Processor board

The automatic feeder contains a processor board. You must dispose of this component separately. Ask your waste disposal company where you can dispose of electronic waste.

12.6 Disposing of the automatic feeder

For disposal instructions, contact the appropriate authorities, such as your waste disposal company or local government agency.

See the appendix for an overview of the materials in the automatic feeder.

Dispose of the automatic feeder.

13 Appendix

13.1 Standard feeding plans

Standard Feeding Plan Group A

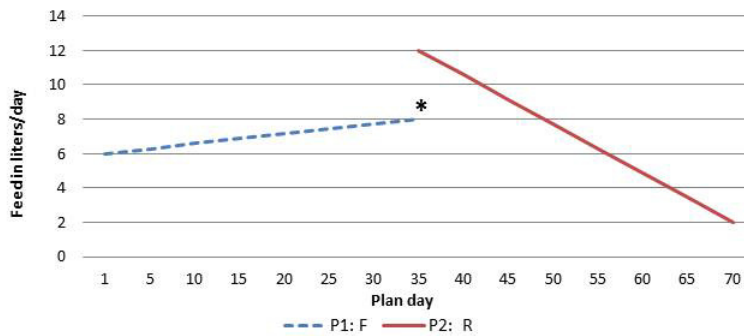

Standard Feeding Plan

P1: 35 days from 6 to 8 L **F**
 P2: 35 days from 12 to 2 L **R**

Total: 70 days

Standard Concentration Plan

P1: 70 days from 150 to 150 g/L

Standard Quantity Limitation Plan

P1: 10 days: 1.5 L (Min) 2.0 L (Max)
 P2: 25 days: 2.0 L (Min) 2.5 L (Max)
 P3: 35 days: 2.0 L (Min) 3.0 L (Max)

F = 40FIT feeding

R = Restricted feeding

* This quantity is not intended as a maximum quantity but as a reference value to calculate an alarm level.

Standard Feeding Plan Group B

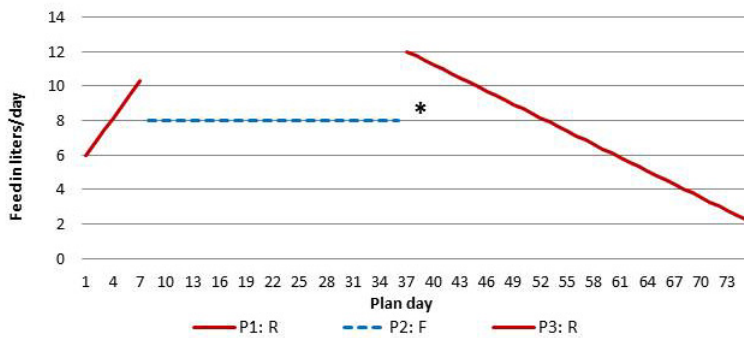

Standard Feeding Plan

P1: 7 days from 6 to 10 L **R**
 P2: 28 days from 8 to 8 L **F**
 P3: 40 days from 12 to 2 L **R**

Total: 75 days

Standard Concentration Plan

P1: 75 days from 150 to 150 g/L

Standard Quantity Limitation Plan

P1: 10 days: 1.5 L (Min) 2.0 L (Max)
 P2: 25 days: 2.0 L (Min) 2.5 L (Max)
 P3: 40 days: 2.0 L (Min) 3.0 L (Max)

F = 40FIT feeding

R = Restricted feeding

* This quantity is not intended as a maximum quantity but as a reference value to calculate an alarm level.

Standard Feeding Plan Group C



Standard Feeding Plan

- P1: 2 days from 5.0 to 5.0 L
- P2: 6 days from 5.0 to 6.0 L
- P3: 21 days from 6.0 to 6.0 L
- P4: 35 days from 6.0 to 2.5 L

Total: 64 days = 316 L

Standard Concentration Plan

- P1: 64 days from 150 to 150 g/L

Total: 64 days = 47.4 kg MP

Standard Quantity Limitation Plan

- P1: 14 days: 1.5 L (Min) 2.0 L (Max)
- P2: 14 days: 2.0 L (Min) 2.5 L (Max)
- P3: 36 days: 2.5 L (Min) 3.0 L (Max)

Standard Feeding Plan Group D

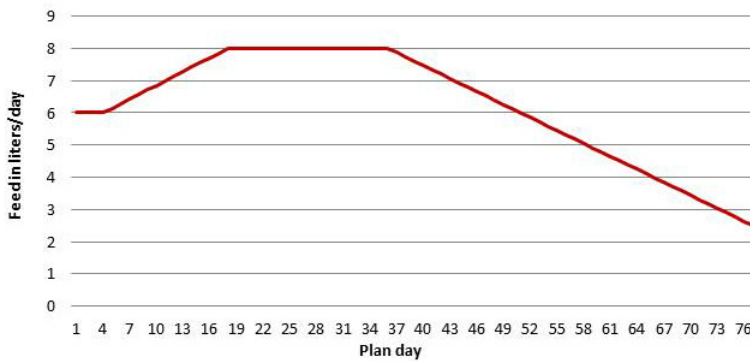

Standard Feeding Plan

- P1: 3 days from 6.0 to 6.0 L
- P2: 14 days from 6.0 to 8.0 L
- P3: 18 days from 8.0 to 8.0 L
- P4: 42 days from 8.0 to 2.5 L

Total: 77 days = 478 L

Standard Concentration Plan

- P1: 77 days from 150 to 150 g/L

Total: 77 days = 71.7 kg MP

Standard Quantity Limitation Plan

- P1: 14 days: 1.5 L (Min) 2.0 L (Max)
- P2: 14 days: 2.0 L (Min) 2.5 L (Max)
- P3: 49 days: 2.5 L (Min) 3.0 L (Max)

13.2 Basic principle of interval feeding

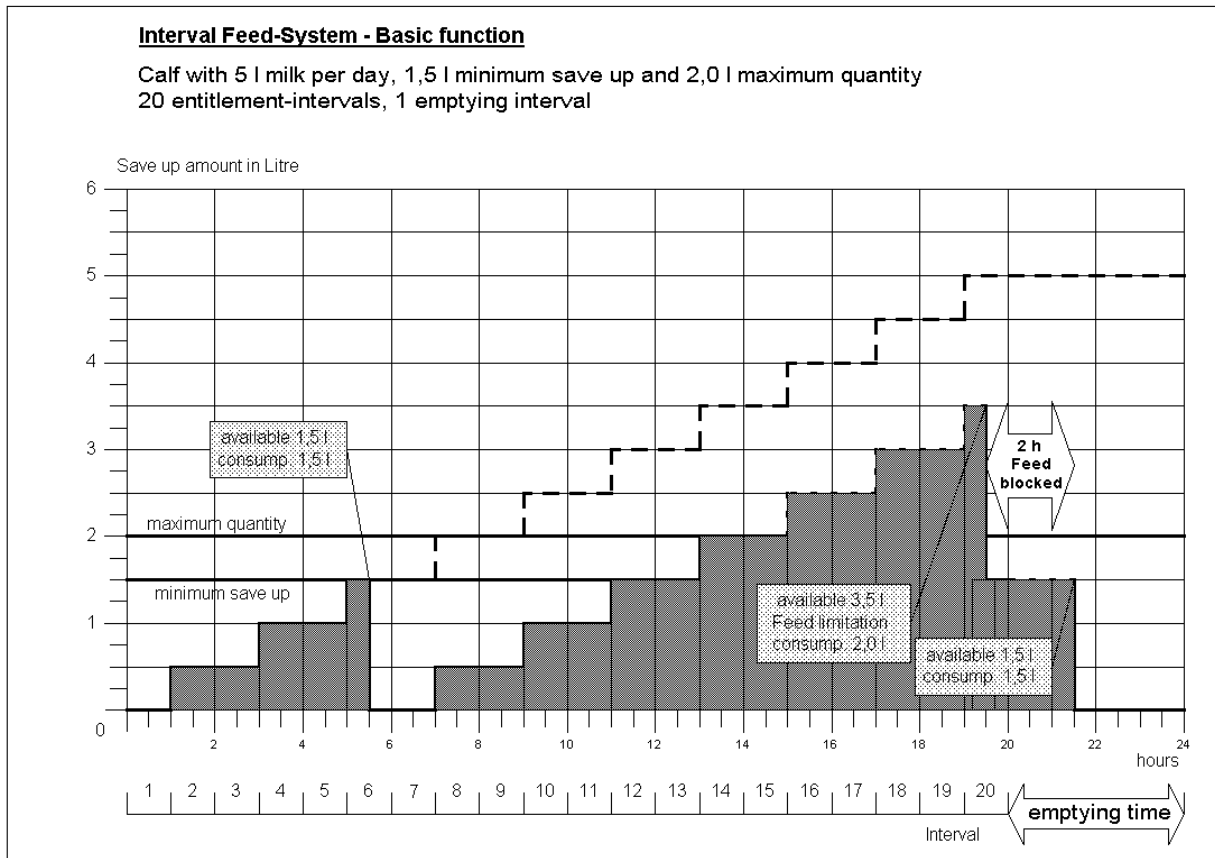

13.3 Milk powder (MP) conversion table

Required concentration (in g/l of feed)	Setting in concentration plan (in g/l of water)	Dry matter (in %/l of feed)
100	111	10.0
105	117	10.5
110	124	11.0
115	130	11.5
120	136	12.0
125	143	12.5
130	149	13.0
140	163	14.0
150	176	15.0
160	190	16.0
170	205	17.0
180	220	18.0
190	235	19.0
200	250	20.0

*) Guide value

13.4 Automatic feeder material list

The materials used in the automatic feeder include:

- Brass, Enzidor®
- Silicon carbide
- Carbon
- V2A, V4A
- Plastics: PET, TPE, silicone, PVC, NBR, ABS, PUR
- Viton
- Vulcanized fiber, graphitized
- Rubber
- Bronze

13.5 Care and maintenance schedule / routine work

Regular maintenance work and functional checks on the automatic feeder and its accessories ensure that the required hygiene standards are maintained. Maintenance includes, for example, calibration, cleaning to maintain hygiene beyond the chapter on cleaning as well as the scheduled replacement of wearing parts. Visual and functional testing of components as well as replacement of simple wearing parts, such as the intake hose, can be carried out by the owner/operator.

Note: Repair work and the replacement of wearing parts on or in the automatic feeder, with the exception of the suction hoses and teats, may **only** be carried out by a service technician.

13.5.1 Important safety information

⚠ DANGER Danger of death by electric shock. The electrical components of the automatic feeder are live. Turning off using the main switch does not disconnect the voltage to the unit. Always turn off the automatic feeder with the main switch and disconnect the power plug before carrying out any work on the automatic feeder or any of its components.

⚠ WARNING There is a risk of injury due to automatic start-up. The automatic feeder automatically prepares a feed portion when it detects a calf entitled to feed. The stirring blades in the mixer jar start automatically and can crush or cut off your hand or fingers. Always turn off the automatic feeder with the main switch and disconnect the power plug before carrying out any work on the mixer. Only clean the powder discharge opening with the scraper supplied.

⚠ WARNING There is a risk of injury due to automatic start-up. Do not reach into the hazardous area of the powder mixing unit. The powder mixing unit can start up automatically at any time, crushing or cutting off your fingers. Turn off the automatic feeder with the main switch and disconnect the power plug before reaching into the powder container.

⚠ WARNING Beware of Chemical burns from cleaning agents. The cleaning agent can cause chemical burns to your eyes or hands. Always wear goggles and protective gloves when using cleaning agents. Follow all the safety instructions listed in the safety data sheet for the cleaning agent and wear the specified safety equipment.

⚠ ATTENTION An interruption or fault in the operation of the automatic feeder means that your calves will not receive any feed. This can lead to malnutrition. Malnutrition can cause impaired growth and development, increased susceptibility to illness or even the death of your calves. You must provide your calves with feed using an alternative method if the automatic feeder is not working properly or is out of service.

13.5.2 Maintenance intervals and activities

Note: If you detect any faults or damage to the automatic feeder between the maintenance intervals recommended below, you must make sure they are rectified immediately by a service technician as required.

	Care/maintenance interval			
	Daily	Weekly	4 months	12 months
Inspection of the calves	✓			
Automatic feeder				
<ul style="list-style-type: none"> Visually inspect for damage. 	✓			
Intensive mixer				
<ul style="list-style-type: none"> Visually check correct functioning of electrodes, temperature sensors and mixer blades. 	✓			
<ul style="list-style-type: none"> Visually inspect mixer for leaks. 	✓			
<ul style="list-style-type: none"> Visually check effectiveness of cleaning cycles. 	✓			
<ul style="list-style-type: none"> Visually inspect mixer screen for clogging and have it cleaned by a service technician, if necessary. 	✓			
<ul style="list-style-type: none"> Check calibration of detergent. 			✓	
Safety devices				
<ul style="list-style-type: none"> Check the completeness and legibility of the safety signs (warning signs). 	✓			
<ul style="list-style-type: none"> Check the proper function of the scraper to clean the powder discharge opening. 	✓			
<ul style="list-style-type: none"> Check functioning of safety grid for powder hopper attachment. 	✓			
Suction hose and teat				
<ul style="list-style-type: none"> Visually check the suction hose and teat for damage and wear and clean them if necessary. 	✓			
<ul style="list-style-type: none"> Replace all milk hoses from mixer to feeding station. 			✓	
<ul style="list-style-type: none"> Replace teats. 			✓	
Power and water supply				
<ul style="list-style-type: none"> Visually inspect for damage. 	✓			
<ul style="list-style-type: none"> Calibrate the water. 			✓	

	Care/maintenance interval			
	Daily	Weekly	4 months	12 months
Shutoff valve/feeding pump <ul style="list-style-type: none"> Have the shutoff valve and feeding pump cleaned by a service technician and have valve membranes with support rings replaced, if necessary. 				✓
Powder mixing unit <ul style="list-style-type: none"> Visually inspect for damage. Check powder discharge opening for foreign bodies. Calibrate MP, at least for every new MP delivery. Empty powder container and check powder conveyor for proper functioning. Perform basic cleaning. 	✓		✓ ✓	✓ ✓
⊕ Check detergent pump <ul style="list-style-type: none"> Check pressure of hose pump and hoses, and visually inspect intake side of pump for damage and wear. Visually check the detergent lance as well as the sieve at the bottom for damages, clogging, incrustation and wearing. Check whether the lid of the detergent container, the hose connection of the detergent lance and the hose connections of the pump have been closed correctly. Perform calibration. Let a service technician replace the pump hose.. 	✓ ✓ ✓		✓	✓
Detergent tank <ul style="list-style-type: none"> Check whether detergent tank is filled, top up if necessary. 	✓			

A

Abbreviations 15
Ad lib mode 41
Alarm levels 82
Alarms 35
Animal control 85
Animal list 85
Arrows 34
Assigning animal numbers 61
Auto LED 29
Automatic mode 30

C

CalfCloud 35, 42
Calibration
 Calibrating using the calibration scale 106
 Manually calibrating 104
Cancel 66
 Group 67
Care and maintenance schedule 130
Cleaning 45
 Basic settings 47
 Cleaning cycle 51
 Cleaning the mixer 48
 Cleaning the mixer jar manually 50
 Cleaning the powder discharge opening 54
 Manually starting mixer cleaning 49
 Rinsing the hose 54
Cleaning agents 46
Cleaning methods 45
Cleaning the detergent lance 56
Cleaning the detergent pump 56
Cloud 42

D

Deleting the transmitter number 63
Detergent lance 56
Disposal 125

E

Extra portions 72

F

Faults 111
 Boiler not filled 113
 Boiler temperature sensor 116
 Calibration 116
 Heating 111, 116
 Mixer emptying 115
 Station/drain valve 117
 Temperature too high 112

Uncontrolled output 117
Water meter 114
Water shortage 113

Feeding plan 67
Feeding plans 75
Filling the milk powder container 69

H

Hand terminal 30
Hazard word
 Caution 21
 Danger 21
 Warning 21
Hazards
 Chemical burns 18
 Electrical breakdown 18
 Excessive strain 19
 Poisoning 18
 Short circuit 18
Hygiene 27

I

Dimensions of the automatic feeder 13
Important safety information 17
Instruction notices 23
Intended use 17
Interval feeding program 129

K

Keypad 32

M

Maintenance 130
Managing transmitters 59
Manual suction hose cleaning 53
Manually entering transmitter numbers 60
Manufacturer's contact details 16
Marking 35
Material damage 19
Material list 130
Milk powder container 14

N

Name plate 10
Navigation 36

O

Obligations 19
Offline mode 29
Operating 29

Operating modes 41
Ad lib mode 41
Rationed mode 41

Unknown transmitters 119
Water connection 13
Weight 13

P

Plan tendency 35
Prohibition notices 22

R

Rationed mode 41
Reading transmitter numbers 60
Register 64
Registering
Automatic 65
automatic 64
Manual 64
Requirements 17
Residual risk 17
Routine tasks 43

S

Safety devices
Safety grid for powder hopper attachment 25
Safety temperature limiter 25
Scraper 26
Safety labels 22
Searching for animals 100
Service messages 124
Sleep mode 36
Standard feeding plans 127
Symbols 34

T

Technical data 13
Transferring 67
Transmitter 59, 65
Creating transmitter number 60
Editing transmitter or animal numbers 62
Retrieving transmitter statistics 63

W

Warning signs 23
Warnings
Calibration 119
Calibration scale 120
Check SD card 122
Double animal number 120
ID chip 120
Identification 117
Machine capacity 121
Mixer emptying 118
Mixer temperature sensor 119

EC declaration of conformity

according to the EU Machinery Directive 2006/42/EG, Annex II, 1.A

Manufacturer:

Förster-Technik GmbH,
Gerwigstr. 25
78234 Engen

Person residing within the Community authorised to compile the relevant technical documentation:

Müller Barbara
Förster-Technik GmbH,
Gerwigstr. 25
78234 Engen

Description and identification of the machinery:

Make: Automatic feeder

Type: TAK5- VS1-*, TAP5-VS1-*, VDW5-VS1-*, TAK5-CS1-*, TAP5-CS1-*, VDW5-CS1-*, TAK5- VH2-*, TAP5-VH2-*, VDW5-VH2-*, TAK5-CH2-*, TAP5-CH2-*, VDW5-CH2-*, TAK1-KU2-*, TAK5-KR3-*, TAP1-ZM2-*, TAP2-ZM2-*, VDW1-WA2-*, TAP7-AH2-*

Function: Automatic preparation, heating, and dosing of liquid feeds for young animal feeding

It is expressly declared that the machinery fulfils all relevant provisions of the following EU Directives:

2006/42/EG Directive 2006/42/EG of the European Parliament and of the Council of 17 May 2006 on machinery, and amending Directive 95/16/EG (recast)

2014/30/EU Directive 2014/30/EU of the European Parliament and of the Council of 26 February 2014 on the harmonisation of the laws of the Member States relating to electromagnetic compatibility (recast)

97/23/EG (Pressure equipment) Directive 97/23/EG on the approximation of the laws of the Member States concerning pressure equipment

Reference to the harmonised standards used, as referred to in Article 7(2):

EN ISO 12100:2010-11 Safety of machinery - Electrical equipment of machines - Part 1: General requirements (ISO 12100:2010)

EN 60335-1:2012/A11:2014 Household and similar electrical appliances - Safety - Part 1: General requirements IEC 60335-1:2010 (modified)

EN 61000-6-2:2005/AC:2005 Electromagnetic compatibility (EMC) - Part 6-2: Generic standards - Immunity for industrial environments

EN 61000-6-3:2007/A1:2011/AC:2012 Electromagnetic compatibility (EMC) - Part 6-3: Generic standards - Emission standard for residential, commercial and light-industrial environments

Engen, 20.04.2016



Place, date

Signature
Markus Förster
CEO