	<b>Mounting info</b>	Spare part set 4 (SP4)	
	<b>Machines</b>	Vario and Compact	
	<b>Date</b>	May 1st, 2014	
Page 1 out of 8	<b>Topic</b>	Servicing	

## Spare part set 4 (SP4)

### 1 Introduction

A service message appears in the automatic feeder display every 4 months. This message indicates the maintenance (rule service) that must be performed. Compliance with these maintenance intervals is the only way to ensure the long life and reliability of the automatic feeder.

Go to **Setup > Service > Last Service** and check when the last rule service was performed or go to **Setup > Service > Next Service** to determine when the next rule service is due.

The following rule services (RS) have been defined:

- RS1 must be performed every 4 months.
- RS2 must be performed every 12 months.
- RS3 must be performed every 36 months.

Depending on the service type to be performed, different spare part sets are required. These mounting instructions take the spare part set 4 (SP4) into consideration. For servicing intervals and spare part set assignment, please refer to the picture below.



**Mounting info** Spare part set 4 (SP4)

**Machines** Vario and Compact

**Date** May 1st, 2014

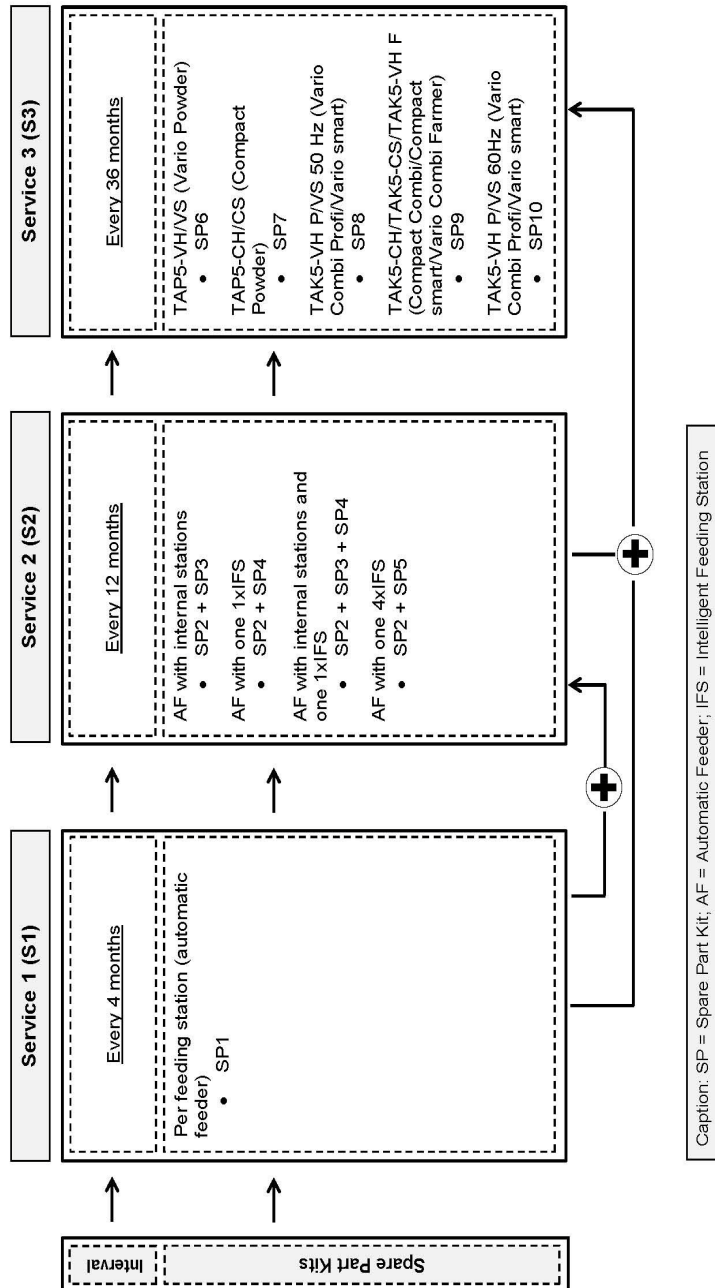
**Topic** Servicing



 	<b>Mounting info</b>	Spare part set 4 (SP4)	
	<b>Machines</b>	Vario and Compact	
	<b>Date</b>	May 1st, 2014	
Page 3 out of 8	<b>Topic</b>	Servicing	

### 1.1 Who is allowed to service the automatic feeder?

Only trained service technicians are authorized to service the automatic feeder.

- > Carefully read all these mounting instructions before servicing the automatic feeder.
- > These mounting instructions must be kept readily available at all times.
- > Observe all of the warnings and safety instructions in these mounting instructions.
- > In addition, observe all of the relevant warnings and safety instructions in the original operating manual of the automatic feeder.



### 1.2 Necessary qualification of service technicians

Service technicians are specialists with the appropriate qualifications. They are able to assess the work assigned to them and detect potential risks on the basis of their technical training as well as their knowledge of the relevant standards. They are familiar with the relevant accident prevention regulations, generally accepted safety regulations and country-specific standards and provisions.

## 2 For your safety

**⚠ WARNING** When using electric appliances, basic precautions should always be followed.

Read and observe all the relevant safety instructions contained in the operating manual of the automatic feeder.

 <b>S29.4e</b>	<b>Mounting info</b>	Spare part set 4 (SP4)	
	<b>Machines</b>	Vario and Compact	
	<b>Date</b>	May 1st, 2014	
Page 4 out of 8	<b>Topic</b>	Servicing	

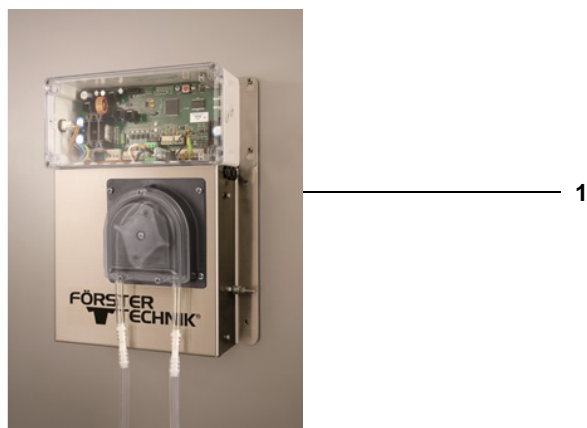

### 3 Which assemblies are affected by SP4?

Assembly „IFS SynchroFeed (single)“



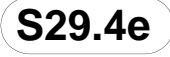

1 IFS SynchroFeed single

2 Pressure sensor

 	<b>Mounting info</b>	Spare part set 4 (SP4)	
	<b>Machines</b>	Vario and Compact	
	<b>Date</b>	May 1st, 2014	
Page 5 out of 8	<b>Topic</b>	Servicing	



## 4 Scope of delivery of SP4

The article number of the complete **SP4** is: **48326**.

	Article no.	Designation	Amount	Position no.
	42438	hose 8.0x1.6mm PUR precision hose L:40 cm	1x	12
	98606	diaphragm 98605 with solenoid for suction- and pressure sensor	1x	24

## 5 What service procedures are to be carried out for RS2?

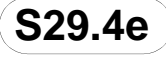
- Visual inspection
  - Check the mixer for cracks and damages.
  - Check the powder hopper for cracks and damages.
  - If available: check the hoses of the IFS feeding station, of the milk tank and the detergent pump.
- Check the level of the detergent.
- Calibrate the feed components, the detergent, the additives, hose pumps and animal scales (if available).
- Carry out the following cleaning processes:
  - With the Powder version: mixer cleaning

 	<b>Mounting info</b>	Spare part set 4 (SP4)	
	<b>Machines</b>	Vario and Compact	
	<b>Date</b>	May 1st, 2014	
Page 6 out of 8	<b>Topic</b>	Servicing	

- With the Combi and fresh milk version: mixer and heat exchanger cleaning as well as sponge cleaning
- Check the error counter in **Main menu > Diagnosis > Control**.
- Carry out a software update.
- Perform a basic cleaning of the shut-off valves.
  - Remove the shut-off valves and dismantle them.
  - Check the valves for proper function. If there are deposits, perform a manual cleaning.
- Replace the parts contained in the spare part set and mount them according to the mounting position below.

**Note:** In the dealer area of the Förster-Technik website a video is available which schematically shows the individual steps required for the replacement of the parts included in the spare part sets.

<b>FÖRSTER TECHNIK®</b> <b>S29.4e</b>	<b>Mounting info</b>	Spare part set 4 (SP4)	
	<b>Machines</b>	Vario and Compact	
	<b>Date</b>	May 1st, 2014	
Page 7 out of 8	<b>Topic</b>	Servicing	

## 6 Mounting position of the spare parts

### 6.1 Assembly „IFS SynchroFeed (single)“

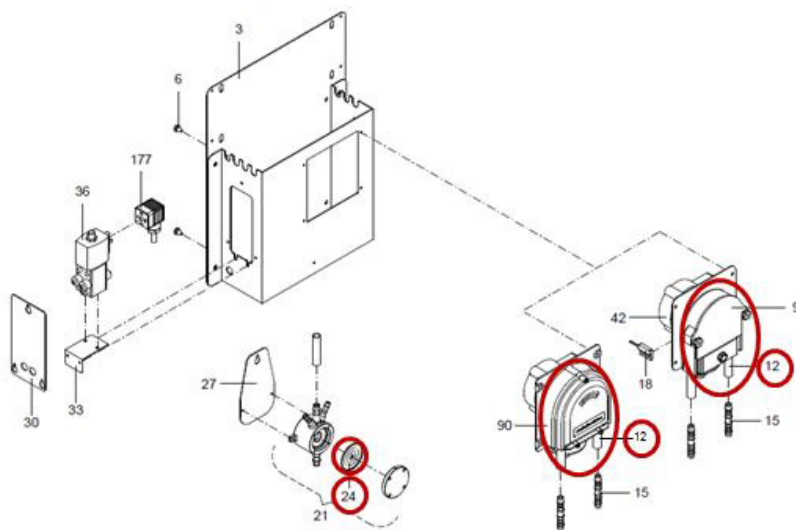

**Mounting info**

Spare part set 4 (SP4)

**Machines**

Vario and Compact

**Date**

May 1st, 2014

**Topic**

Servicing

