	Mounting info	Spare part kit 8 (SP8)	
	Machines	Vario Combi Profi / Vario smart Combi 50Hz	
	Date	June 17th, 2016	
Page 1 out of 12	Topic	Servicing	

Spare part kit 8 (ET8)

1 Introduction

A service message appears in the automatic feeder display every 4 months. This message indicates the maintenance (rule service) that must be performed. Compliance with these maintenance intervals is the only way to ensure the long life and reliability of the automatic feeder.

Go to **Setup > Service > Last Service** and check when the last rule service was performed or go to **Setup > Service > Next Service** to determine when the next rule service is due.

The following rule services (RS) have been defined:



- RS1 must be performed every 4 months.
- RS2 must be performed every 12 months.
- RS3 must be performed every 36 months.

Depending on the service type to be performed, different spare part sets are required. These mounting instructions take the spare part set 8 (SP8) into consideration. For servicing intervals and spare part set assignment, please refer to the picture below.

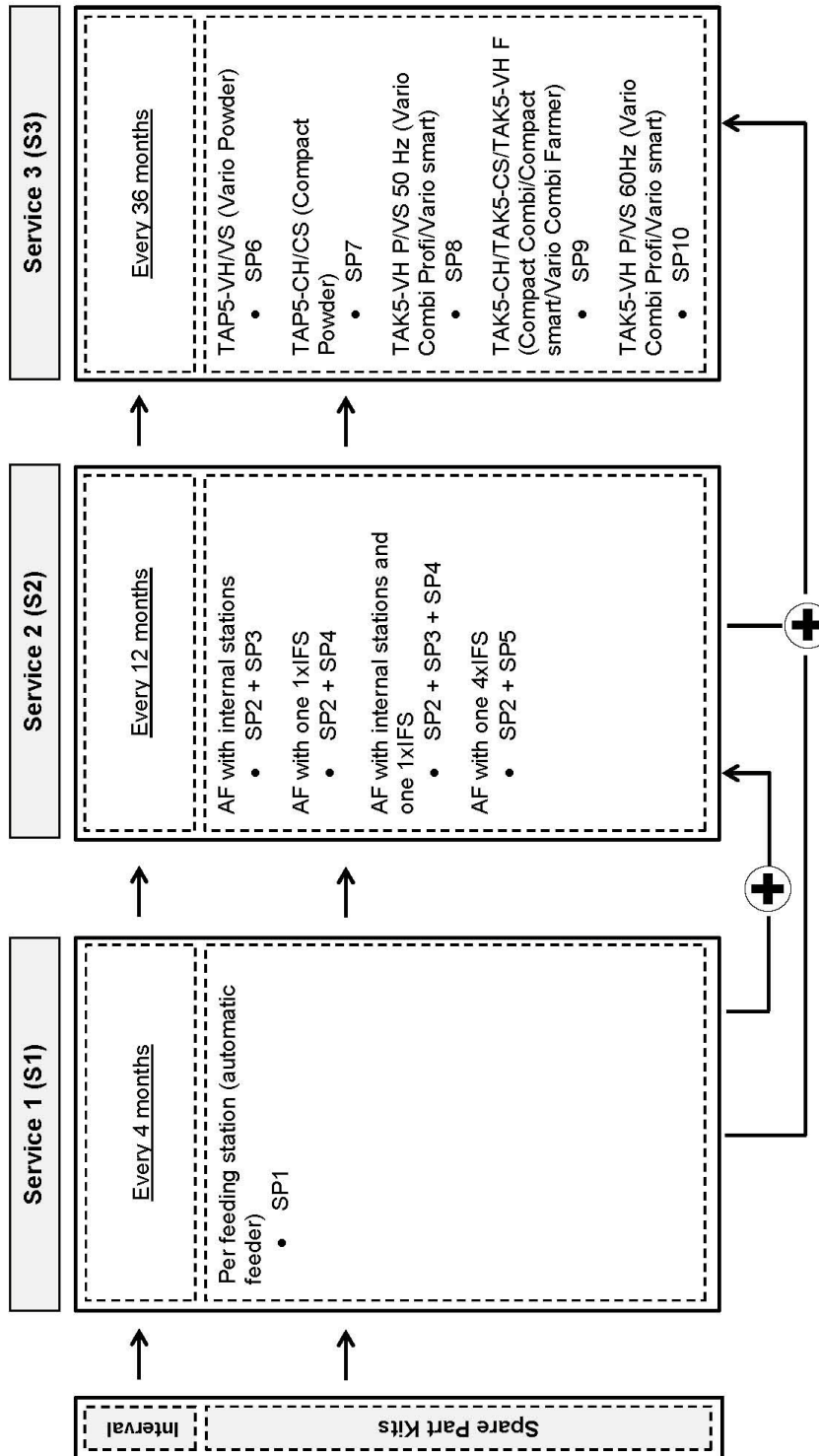
Mounting info	Spare part kit 8 (SP8)
Machines	Vario Combi Profi / Vario smart Combi 50Hz
Date	June 17th, 2016
Topic	Servicing

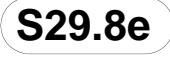

Caption: SP = Spare Part Kit; AF = Automatic Feeder; IFS = Intelligent Feeding Station

 	Mounting info	Spare part kit 8 (SP8)	
	Machines	Vario Combi Profi / Vario smart Combi 50Hz	
	Date	June 17th, 2016	
Page 3 out of 12	Topic	Servicing	

1.1 Who is allowed to service the automatic feeder?

Only trained service technicians are authorized to service the automatic feeder.

- > Carefully read all these mounting instructions before servicing the automatic feeder.
- > These mounting instructions must be kept readily available at all times.
- > Observe all of the warnings and safety instructions in these mounting instructions.
- > In addition, observe all of the relevant warnings and safety instructions in the original operating manual of the automatic feeder.



1.2 Necessary qualification of service technicians

Service technicians are specialists with the appropriate qualifications. They are able to assess the work assigned to them and detect potential risks on the basis of their technical training as well as their knowledge of the relevant standards. They are familiar with the relevant accident prevention regulations, generally accepted safety regulations and country-specific standards and provisions.

2 For your safety

⚠ WARNING When using electric appliances, basic precautions should always be followed.

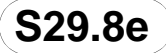
Read and observe all the relevant safety instructions contained in the operating manual of the automatic feeder.



 	Mounting info	Spare part kit 8 (SP8)	
	Machines	Vario Combi Profi / Vario smart Combi 50Hz	
	Date	June 17th, 2016	
Page 4 out of 12	Topic	Servicing	

3 Which assemblies are affected by SP8?

Heat exchanger, milk/water supply, intensive mixer and valves

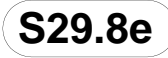

1. Heat exchanger
2. Water supply
3. Intensive mixer
4. Valves



 	Mounting info	Spare part kit 8 (SP8)	
	Machines	Vario Combi Profi / Vario smart Combi 50Hz	
	Date	June 17th, 2016	
Page 5 out of 12	Topic	Servicing	

4 Scope of delivery SP8



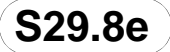

The article number of the complete **SP8** is: **48330**.

4.1 Assembly milk/water supply



	Article no.	Designation	Amount	Position nr.
	99469	Valve component - 98401 seal ED:6 L:3.2 (jet 4.0) dark brown	2x	201
	10211	Shaft seal for milk pump with sp- line and circlip; as of 01/93	1x	78
	90305	Repair kit for VA-pump 230V 50Hz 250W	1x	81
	47694	Hose 10.0 EDx1.5mm PUR-H transparent 98ShoreA, hydrolyse-	1x	33
		Seal 24,0x17x2mm graphite- coated	2x	36
		Seal 18,5x12,0x2mm hard vu- lcanized fiber red	1x	24
		Seal 23,5x15,0x2mm hard	1x	102



 	Mounting info	Spare part kit 8 (SP8)	
	Machines	Vario Combi Profi / Vario smart Combi 50Hz	
	Date	June 17th, 2016	
Page 6 out of 12	Topic	Servicing	

4.2 Assembly heat exchanger



	Article no.	Designation	Amount	Position nr.
	99146	Seal thickness D: 5mm for plastic container HE	1x	75
		Seal 20,0x13x2mm HD300 green graphite-coated on both sides	1x	123
		Seal 29,0x21,5x2mm vulcanized fiber red hard	1x	24
		Seal 18,5x12,0x2mm hard vulcanized fiber red	1x	30

4.3 Assembly intensive mixer

	Article no.	Designation	Amount	Position nr.
	103329	Rotary seal complete	1x	27
	80019	O-ring 58,0x3,0mm NBR 50 Shore (mixer motor)	1x	24



 	Mounting info	Spare part kit 8 (SP8)	
	Machines	Vario Combi Profi / Vario smart Combi 50Hz	
	Date	June 17th, 2016	
Page 7 out of 12	Topic	Servicing	

4.4 Assembly stop valve + clean. valve + feeding pump

	Article no.	Designation	Amount	Position nr.
	47694	Hose 10.0 EDx1.5mm PUR-H transparent 98ShoreA, hydrolyse-	1x	102
	40549	Plug-type connector 1/4" ET; ID:10/7.5 L:30mm	2x	42

5 What service procedures are to be carried out for RS8?

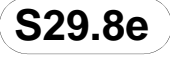
- Visual inspection
 - Check the mixer for cracks and damages.
 - Check the powder hopper for cracks and damages.
 - If available: check the hoses of the IFS feeding station, of the milk tank and the detergent pump.
- Check the level of the detergent.
- Calibrate the feed components, the detergent, the additives, hose pumps and animal scales (if available).
- Carry out the following cleaning processes:
 - With the Powder version: mixer cleaning
 - With the Combi and fresh milk version: mixer and heat exchanger cleaning as well as sponge cleaning

 	Mounting info	Spare part kit 8 (SP8)	
	Machines	Vario Combi Profi / Vario smart Combi 50Hz	
	Date	June 17th, 2016	
Page 8 out of 12	Topic	Servicing	

- Check the error counter in **Main menu > Diagnosis > Control**.
- Carry out a software update.
- Perform a basic cleaning of the shut-off valves.
 - Remove the shut-off valves and dismantle them.
 - Check the valves for proper function. If there are deposits, perform a manual cleaning.
- Perform a boiler cleaning/heat exchanger cleaning.
- Replace the parts contained in the spare part set and mount them according to the mounting position below.

Note: In the dealer area of the Förster-Technik website a video is available which schematically shows the individual steps required for the replacement of the parts included in the spare part sets.

Mounting info

Spare part kit 8 (SP8)

Machines

Vario Combi Profi / Vario smart
Combi 50Hz

Date

June 17th, 2016

Topic

Servicing



6.2 Assembly heat exchanger

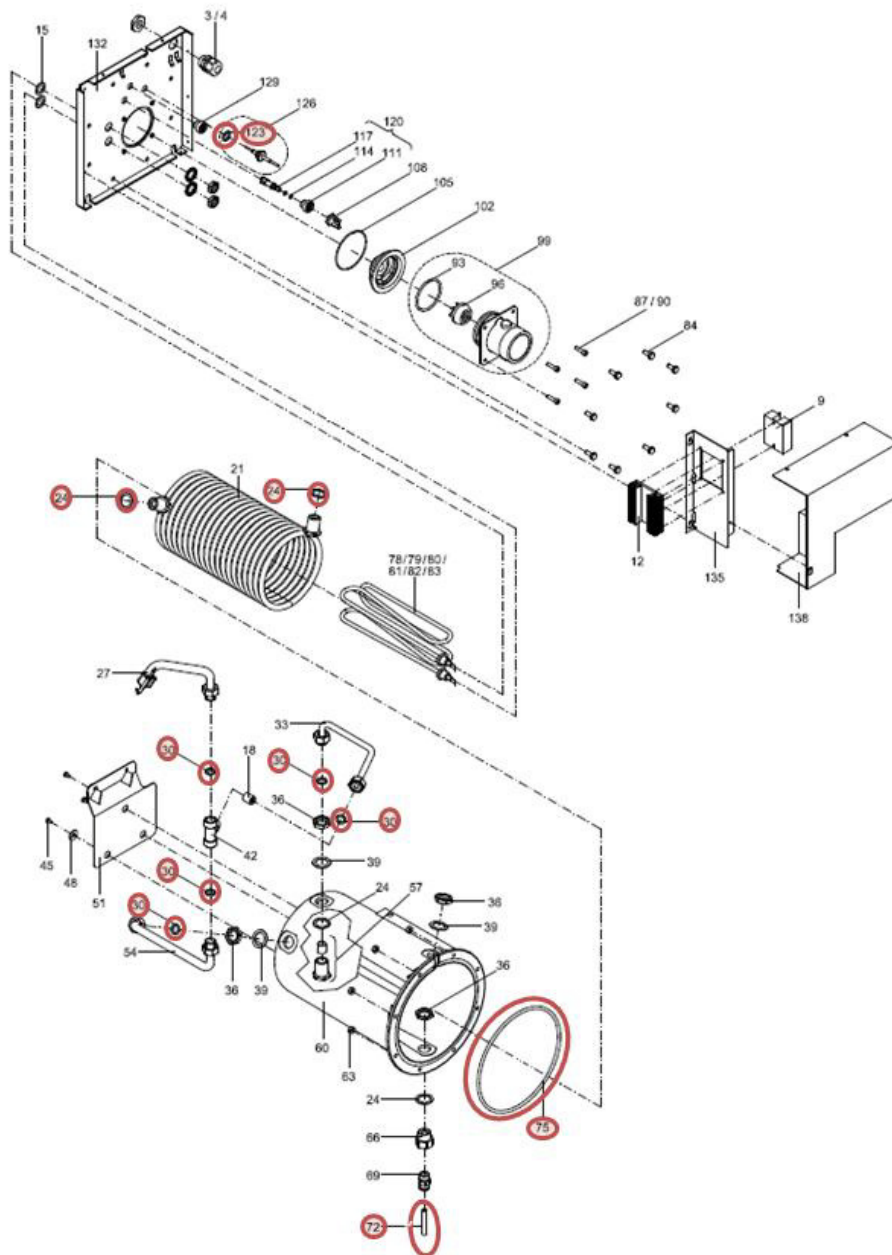

FÖRSTER TECHNIK® S29.8e	Mounting info	Spare part kit 8 (SP8)	
	Machines	Vario Combi Profi / Vario smart Combi 50Hz	
	Date	June 17th, 2016	
Page 11 out of 12	Topic	Servicing	

6.3 Assembly intensive mixer

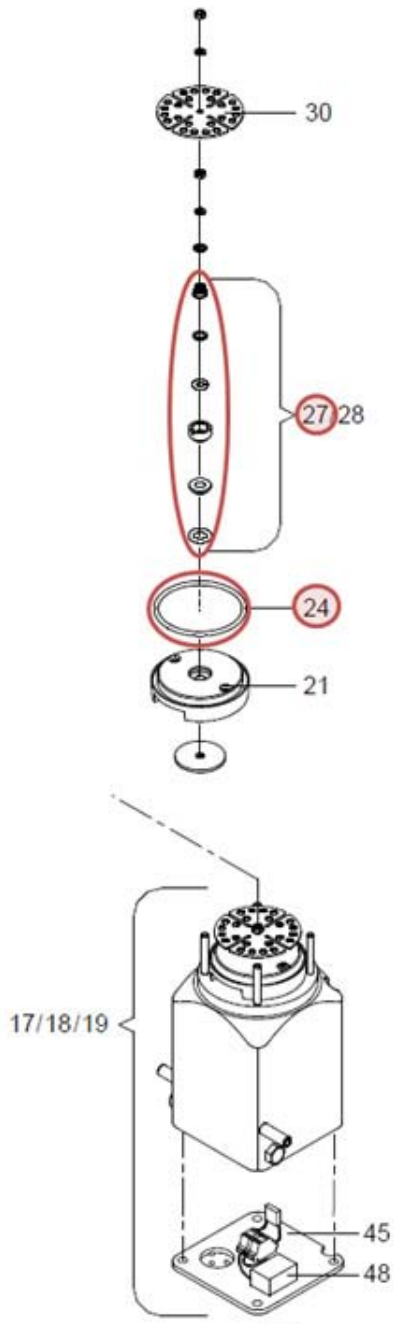

Mounting info

Spare part kit 8 (SP8)

Machines

Vario Combi Profi / Vario smart
Combi 50Hz

Date

June 17th, 2016

Topic

Servicing



6.4 Assembly stop valve + clean. valve + feeding pump

