

mains connection
240V/60Hz

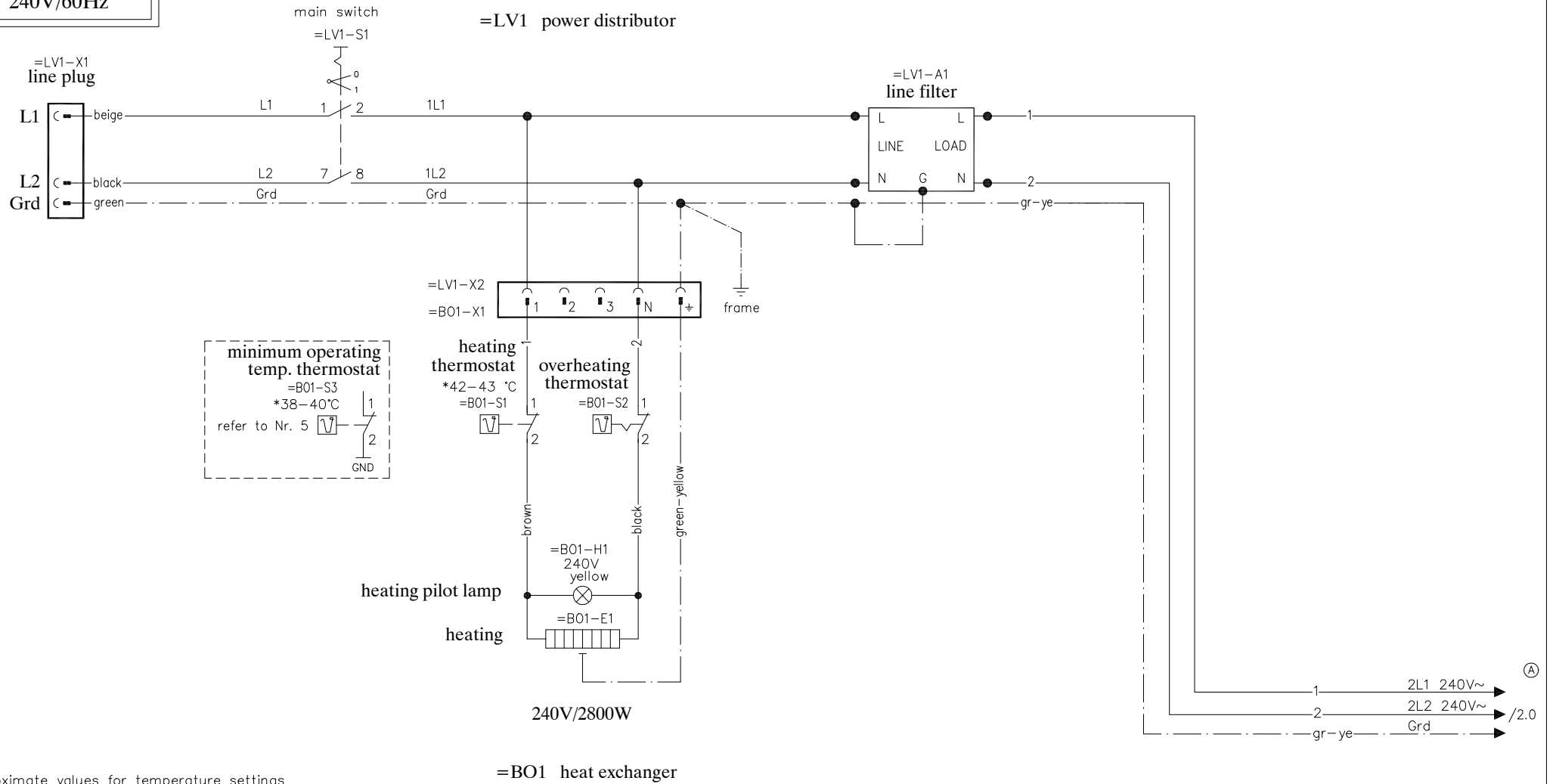

* approximate values for temperature settings

				TAP5-SM2-28-P1 with relay interface USA / Canada		Förster Technik GmbH		Zeichnungs-Nr. PL10100		Blatt 1	
						gezeichnet		Datum 08.10.2001		Gültig ab: 08.10.2001	
Änderung				Ind. Datum Name		Name jr		Gültig bis:		von 9 Blätter	

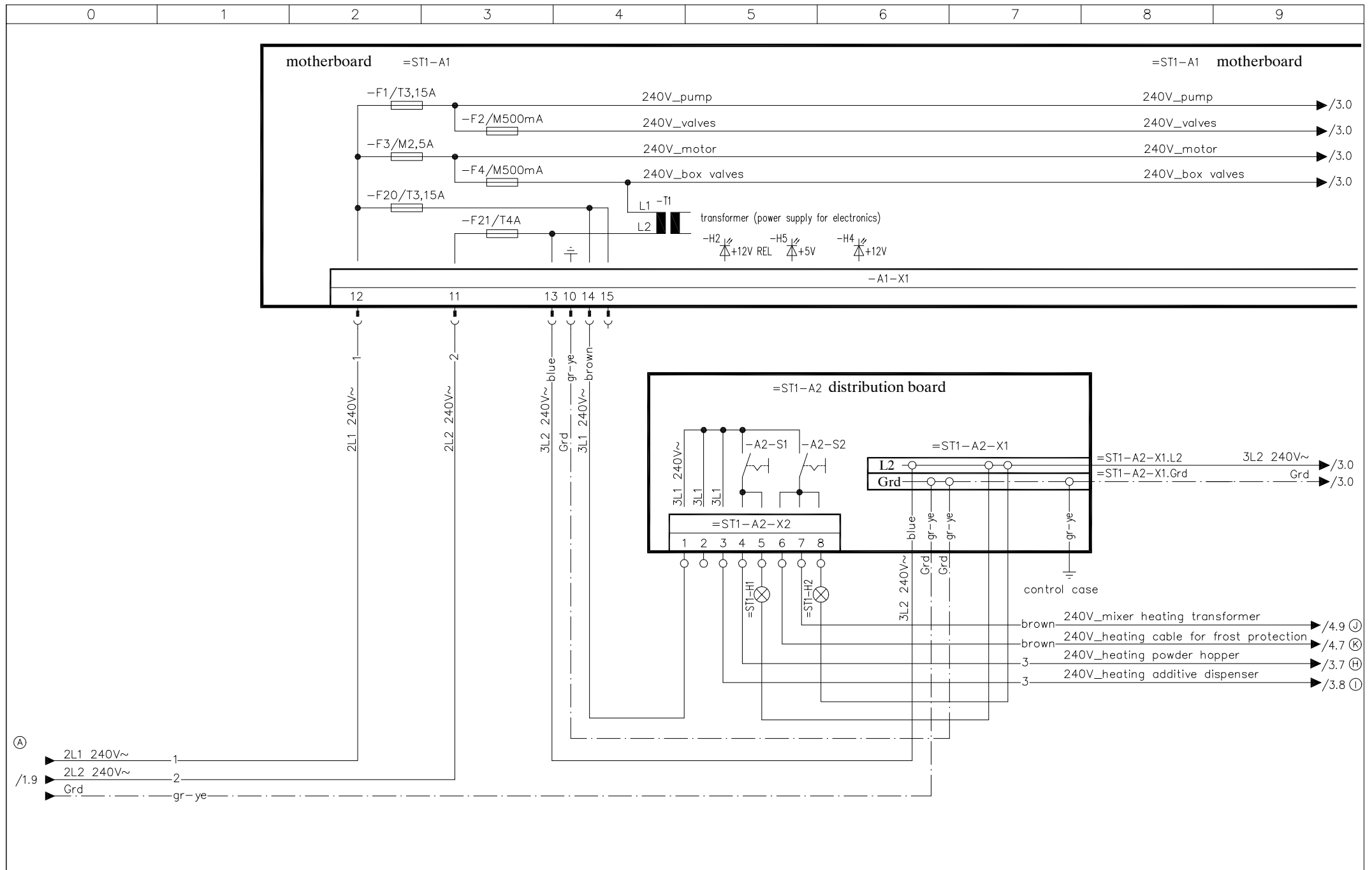

				TAP5-SM2-28-P1 with relay interface USA / Canada		Förster Technik GmbH		Zeichnungs-Nr. PL10100		Blatt 2		
						gezeichnet		Datum 08.10.2001		Versions-Nr. a		von 9 Blätter
Änderung				Ind.	Datum	Name	Name jr		Gültig ab: 08.10.2001		Gültig bis:	

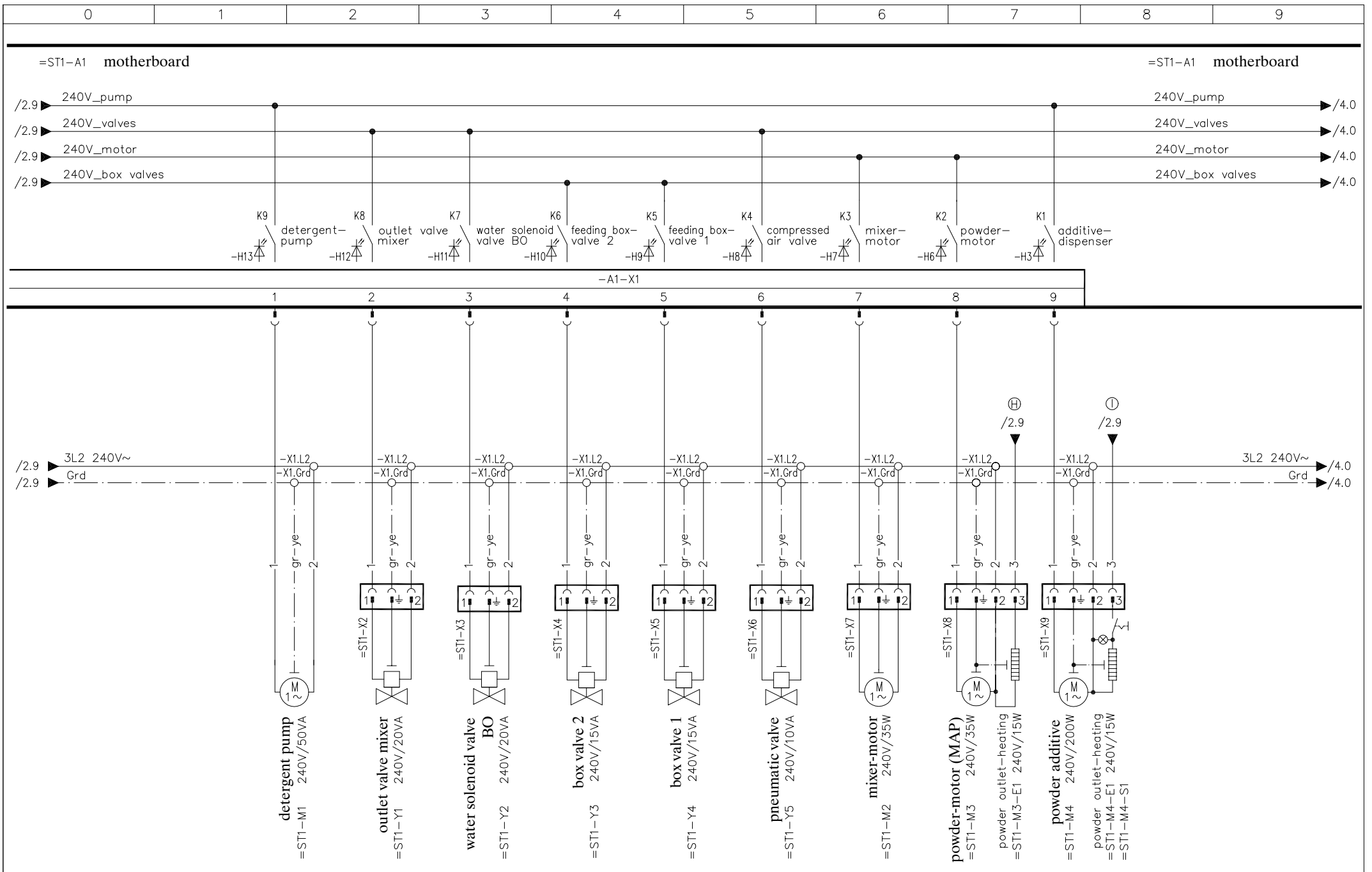

				TAP5-SM2-28-P1 with relay interface USA / Canada		Förster Technik GmbH		Zeichnungs-Nr. PL10100		Blatt 3	
						gezeichnet		Datum 08.10.2001		Versions-Nr. a	
Änderung				Ind.		Datum		Name			
						Name jr		Gültig ab: 08.10.2001		Gültig bis:	

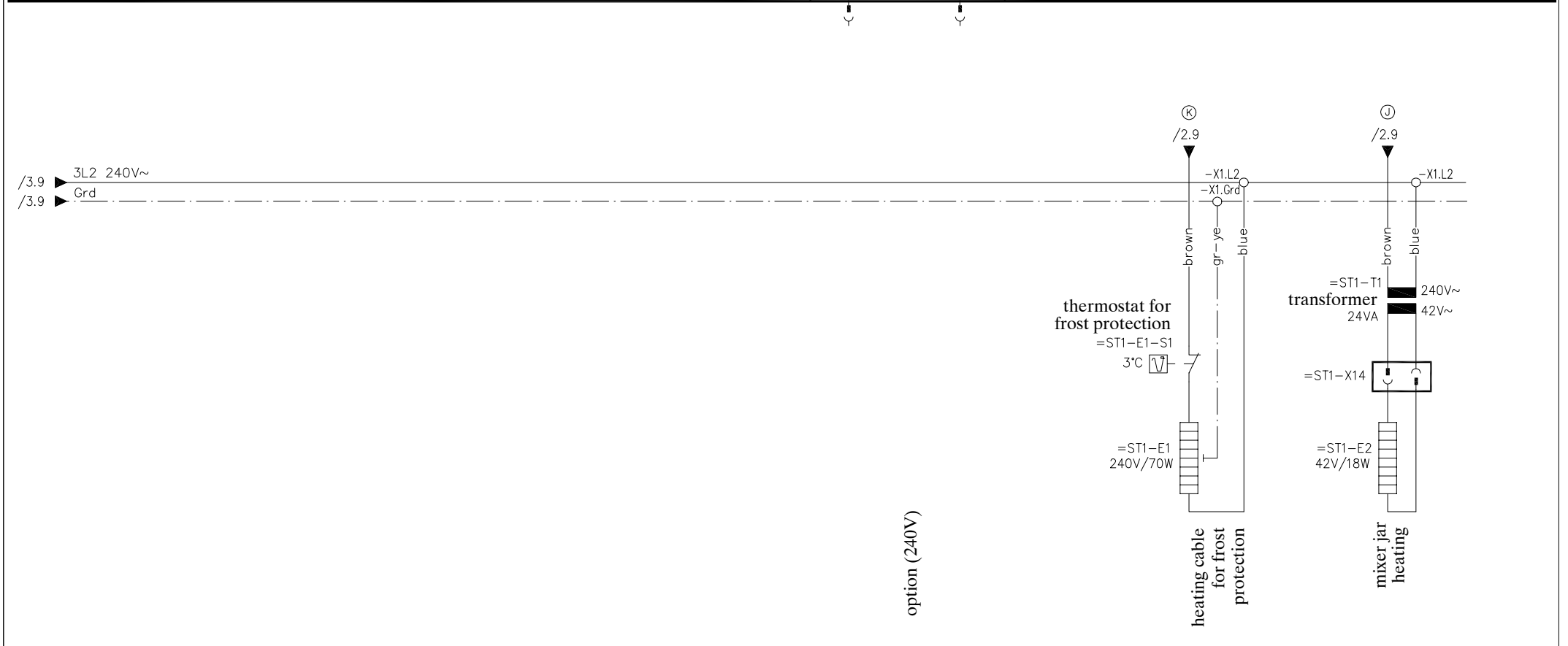
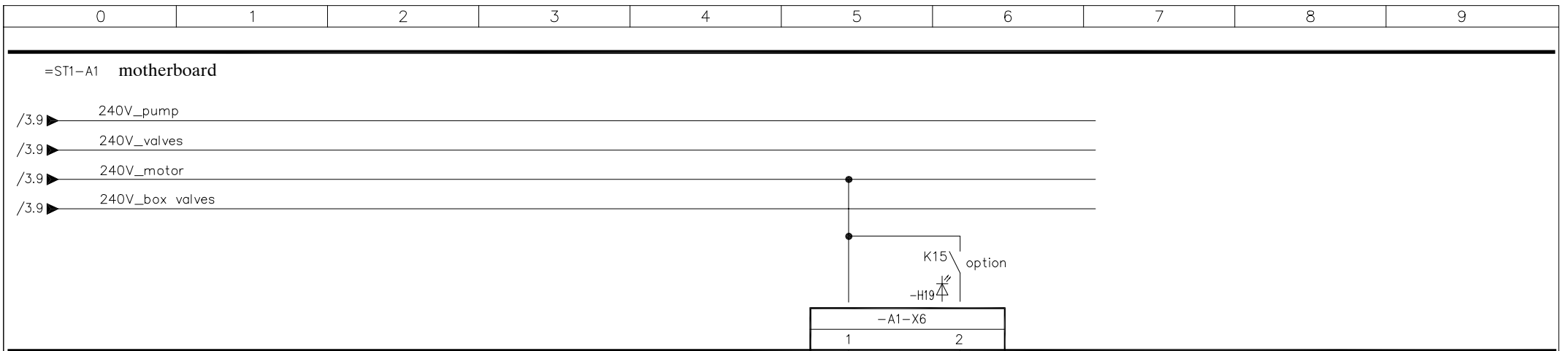

				TAP5-SM2-28-P1 with relay interface USA / Canada	Förster Technik GmbH	Zeichnungs-Nr. PL10100	Blatt 4
					gezeichnet	Datum 08.10.2001	Gültig ab: 08.10.2001
Änderung	Ind.	Datum	Name		Name jr	Gültig bis:	von 9 Blätter

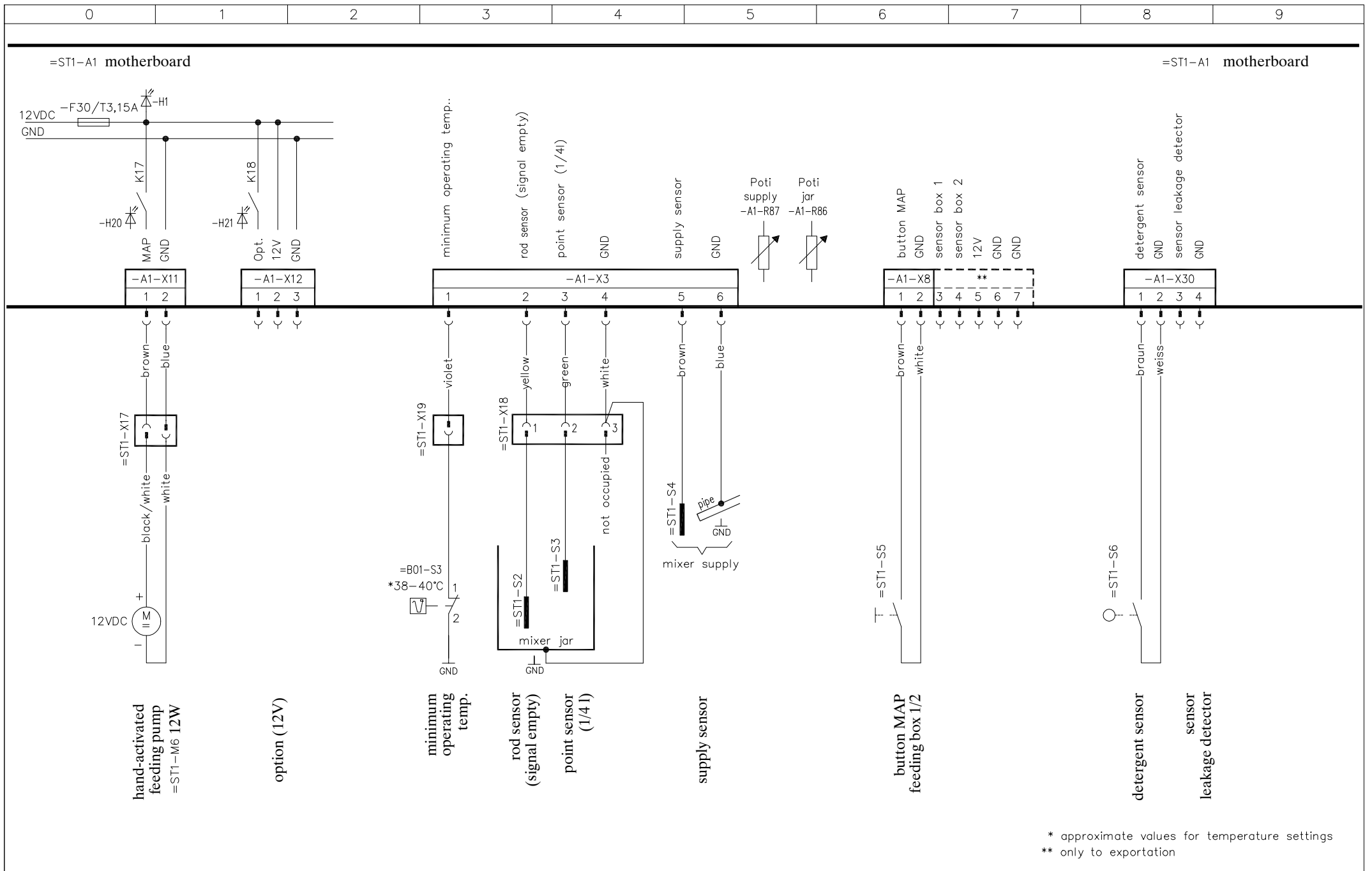

				TAP5-SM2-28-P1 with relay interface USA / Canada		Förster Technik GmbH		Zeichnungs-Nr. PL10100		Blatt 5	
						gezeichnet		Versions-Nr. a		von 9 Blätter	
Änderung				Ind. Datum Name		Datum 08.10.2001 Name jr		Gültig ab: 08.10.2001 Gültig bis:			

=ST1-A1 motherboard

=ST1-A1 motherboard

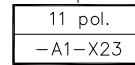
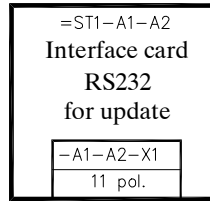

Interface RS232
for update

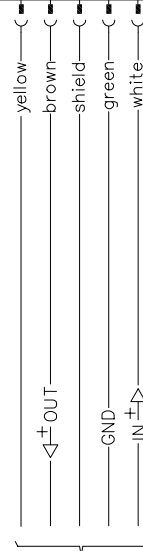
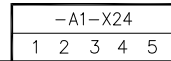

update cable
(see sep. diagram)

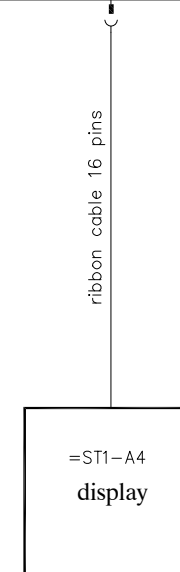
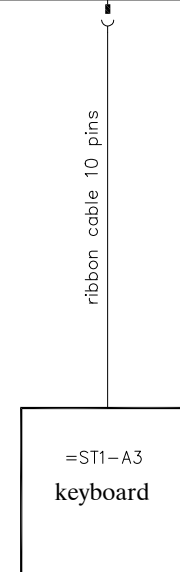
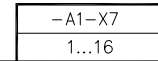
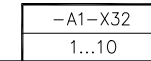
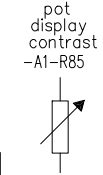

Änderung	Ind.	Datum	Name

TAP5-SM2-28-P1
with relay interface
USA / Canada

Förster Technik GmbH	Zeichnungs-Nr.	PL10100	Blatt 6
	Versions-Nr.	a	
gezeichnet Name jr	Datum 08.10.2001	Gültig ab: 08.10.2001	von 9 Blätter
		Gültig bis:	

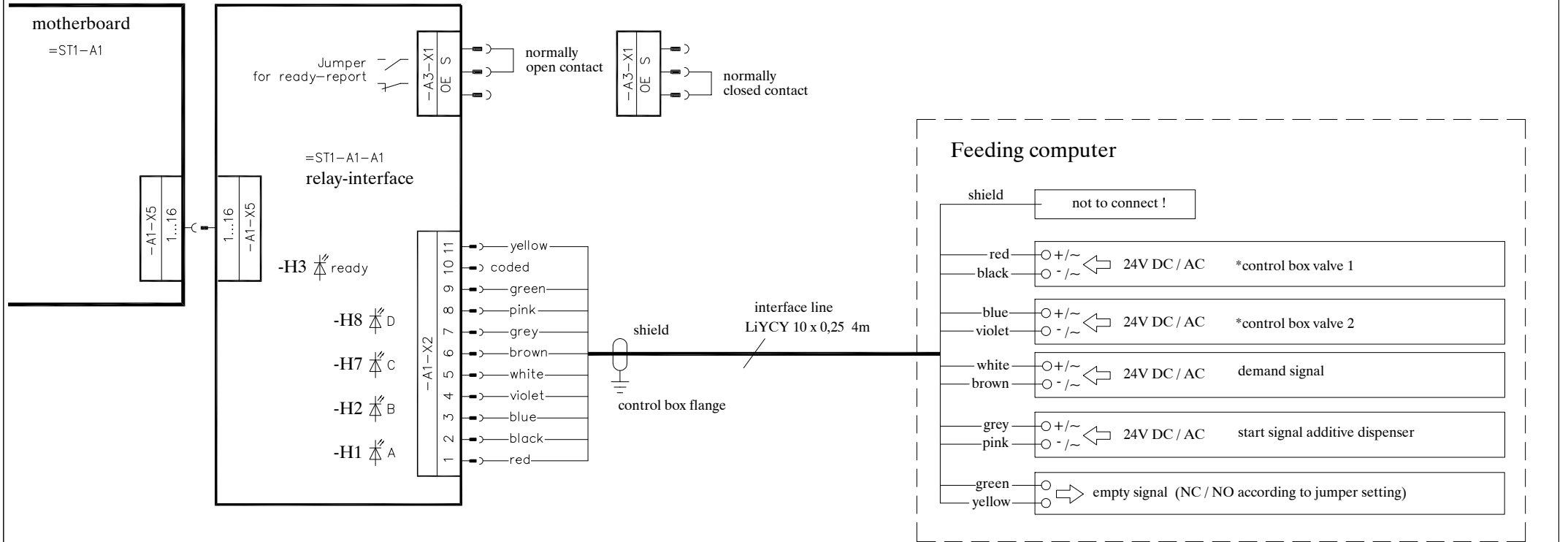

* not available on each feeding computer (see user's manual)

				TAP5-SM2-28-P1 with relay interface USA / Canada	Förster Technik GmbH	Zeichnungs-Nr. PL10100	Blatt 7
						gezeichnet	
Änderung	Ind.	Datum	Name		Datum 08.10.2001	Gültig ab: 08.10.2001	von 9 Blätter
					Name jr	Gültig bis:	

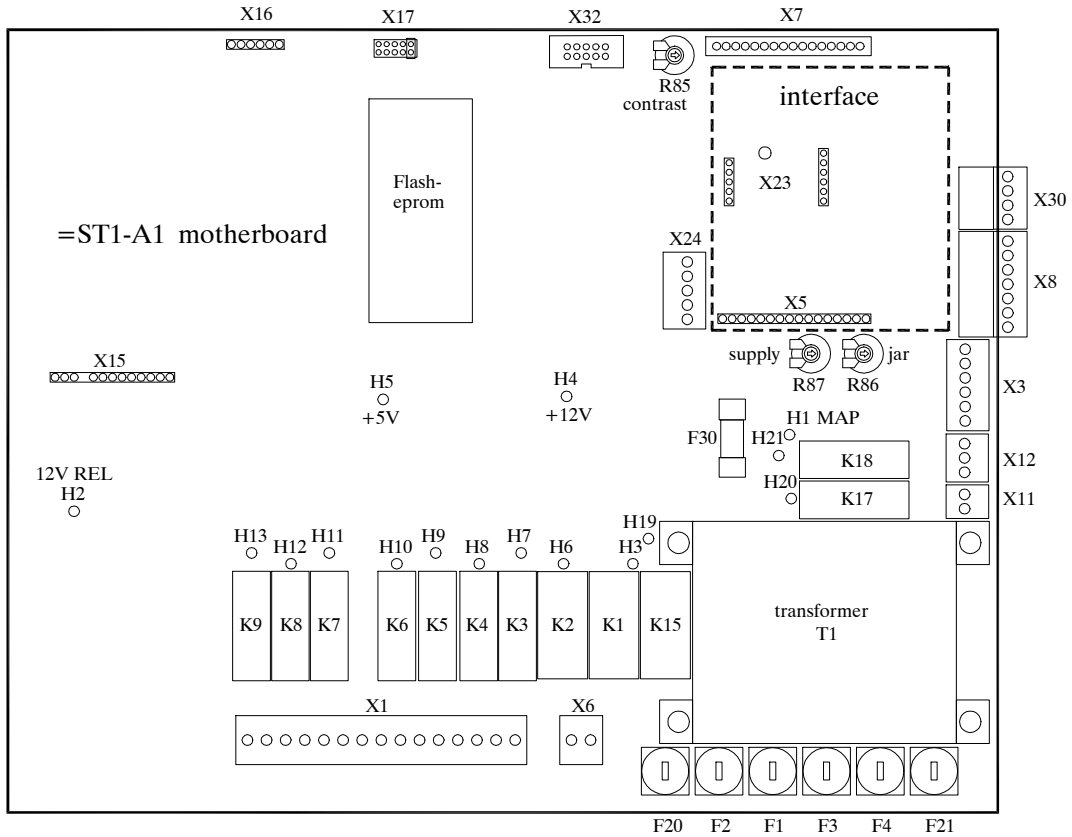

=ST1-A1-A1 relay-interface

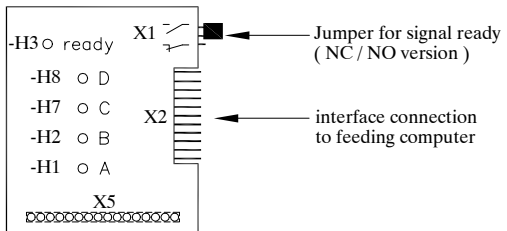

=ST1-A1-A2 interface card RS232 for update

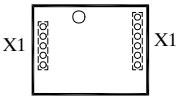

switch on/off powder outlet heating switch on/off heating cable for frost protection
 =ST1-A2 distribution board

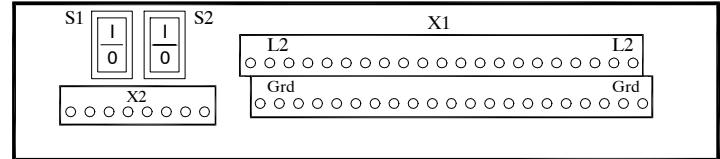

				TAP5-SM2-28-P1 with relay interface USA / Canada	Förster Technik GmbH		Zeichnungs-Nr. PL10100	Blatt 8
					gezeichnet		Datum 08.10.2001	
Änderung				Ind.	Datum	Name	Gültig ab: 08.10.2001	von 9 Blätter
							Gültig bis:	

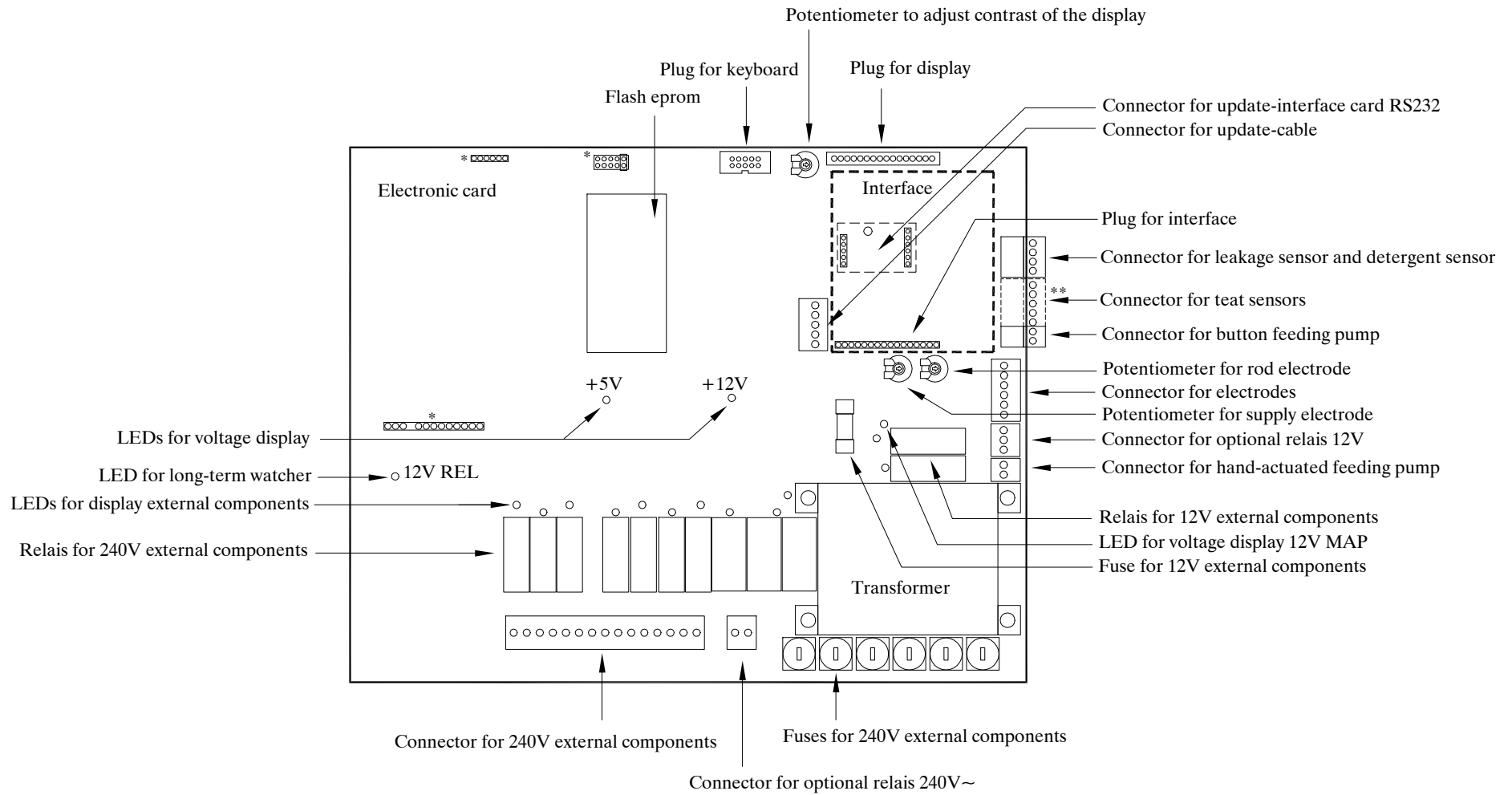

* Plug for check
 ** depending on the model

				TAP5-SM2-28-P1 with relay interface USA / Canada	Förster Technik GmbH		Zeichnungs-Nr.	PL10100	Blatt 9	
					gezeichnet	Datum 08.10.2001	Gültig ab:	08.10.2001	von 9 Blätter	
Änderung	Ind.	Datum	Name			Name jr	Gültig bis:			