

**mains connection**  
200V/L1,L2/Grd/50Hz/60Hz

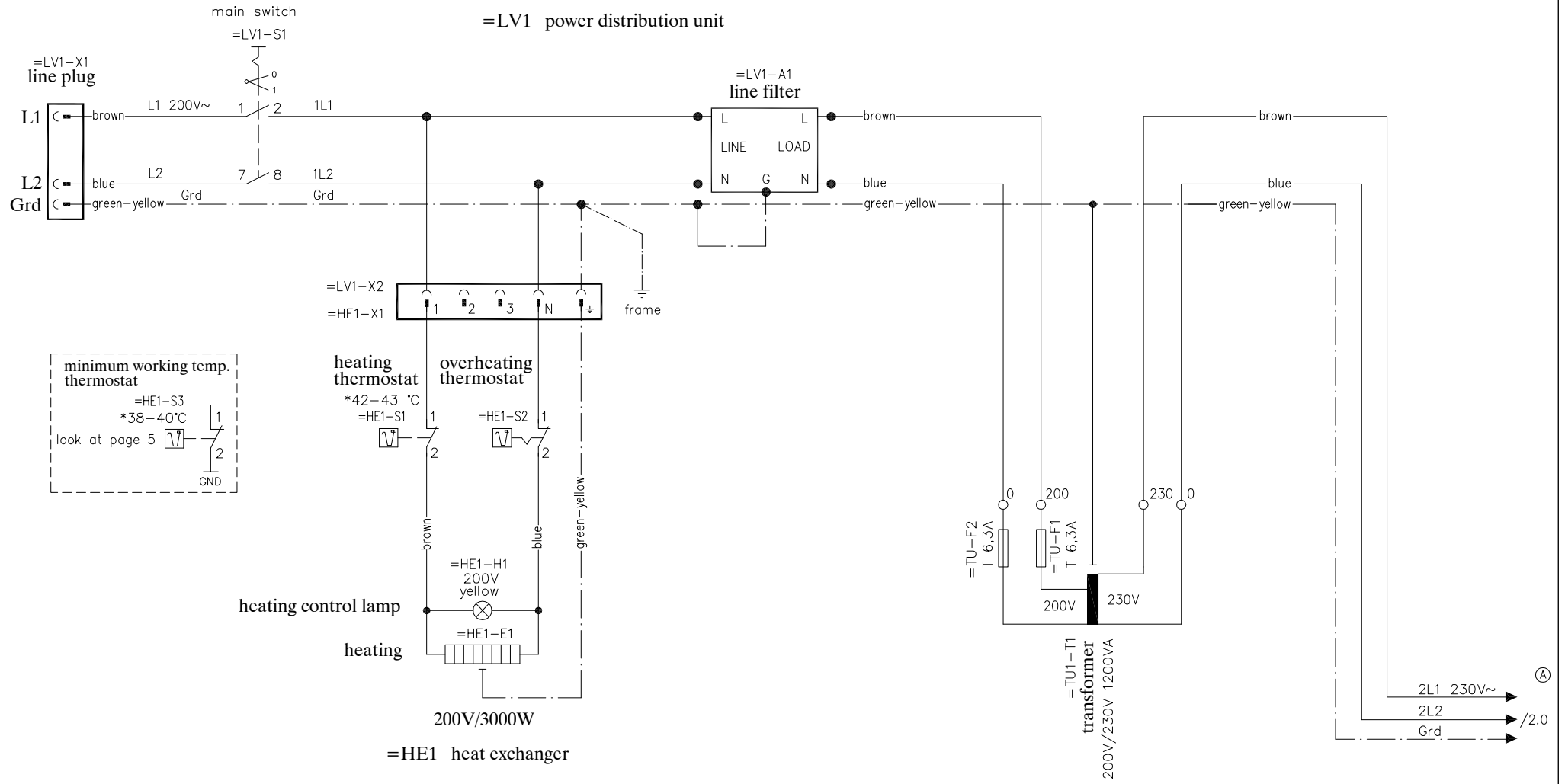

\*approximate values temperature settings

				TAK5-SM2-30-P1 with relay interface Japan	Förster Technik GmbH	Zeichnungs-Nr. PL10229	Blatt 1
					gezeichnet	Versions-Nr. a	von 9 Blätter
Änderung	Ind.	Datum	Name		Datum 02.04.2003 Name jr	Gültig bis:	

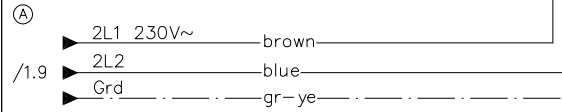
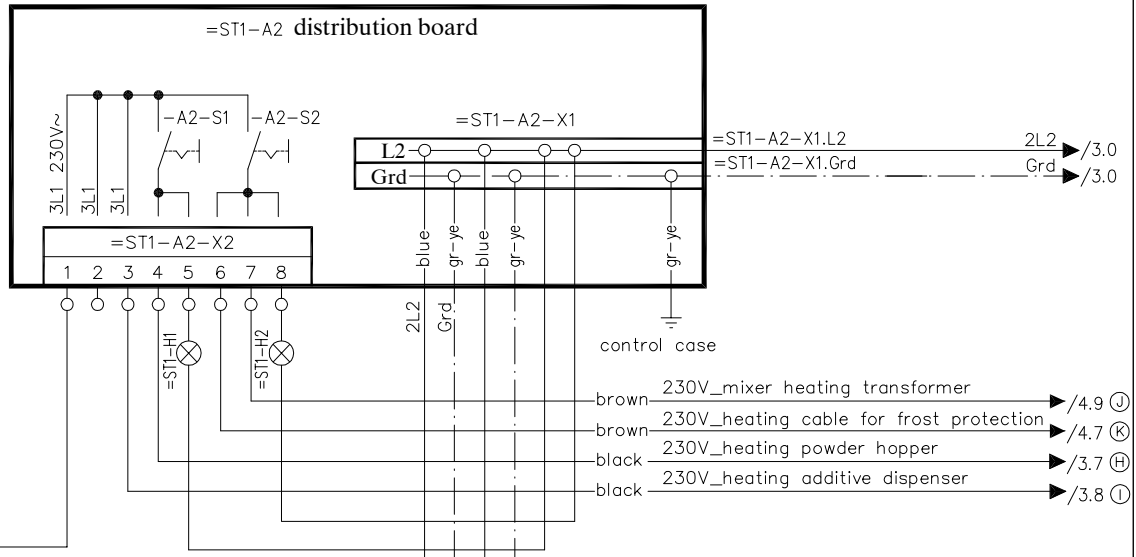
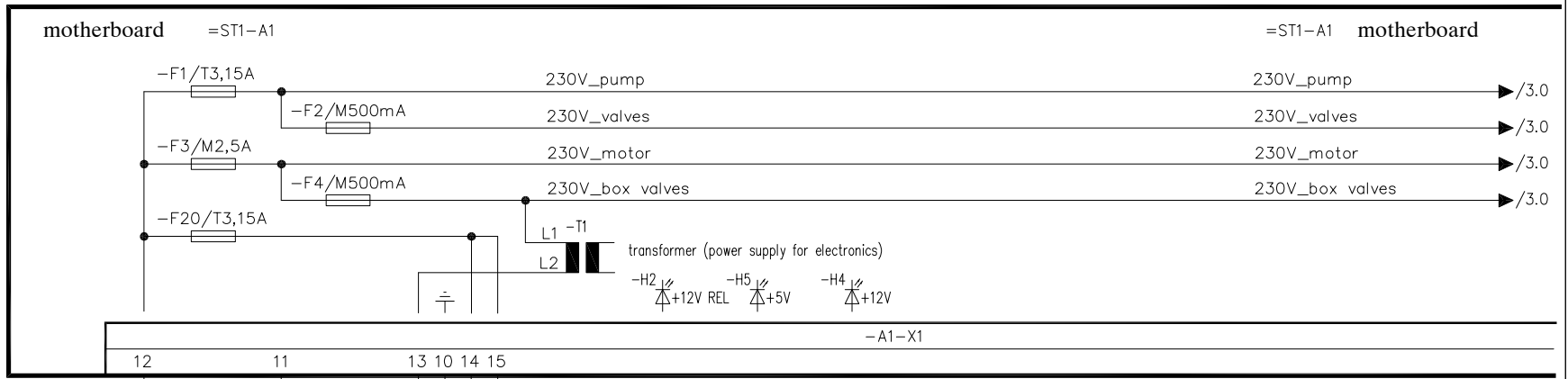

				TAK5-SM2-30-P1 with relay interface Japan		Förster Technik GmbH		Zeichnungs-Nr. PL10229		Blatt 2	
						gezeichnet		Versions-Nr. a		von 9 Blätter	
Änderung				Ind. Datum Name		Datum 02.04.2003 Name jr		Gültig bis:			

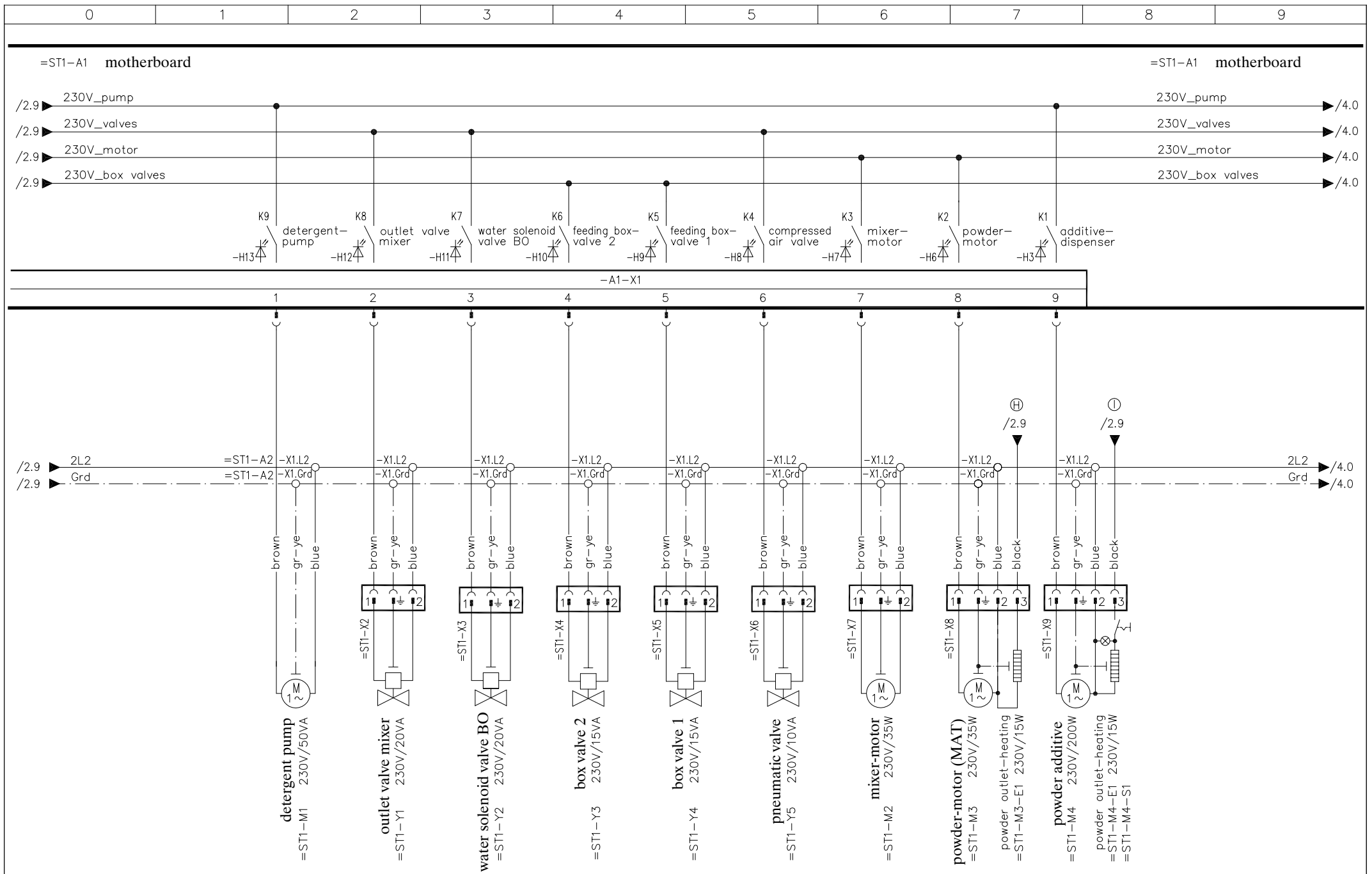

				TAK5-SM2-30-P1 with relay interface Japan		Förster Technik GmbH		Zeichnungs-Nr. PL10229		Blatt 3	
						gezeichnet Datum 02.04.2003		Versions-Nr. a		von 9 Blätter	
Änderung				Ind. Datum Name		Name jr		Gültig bis:			

**=ST1-A1 motherboard**

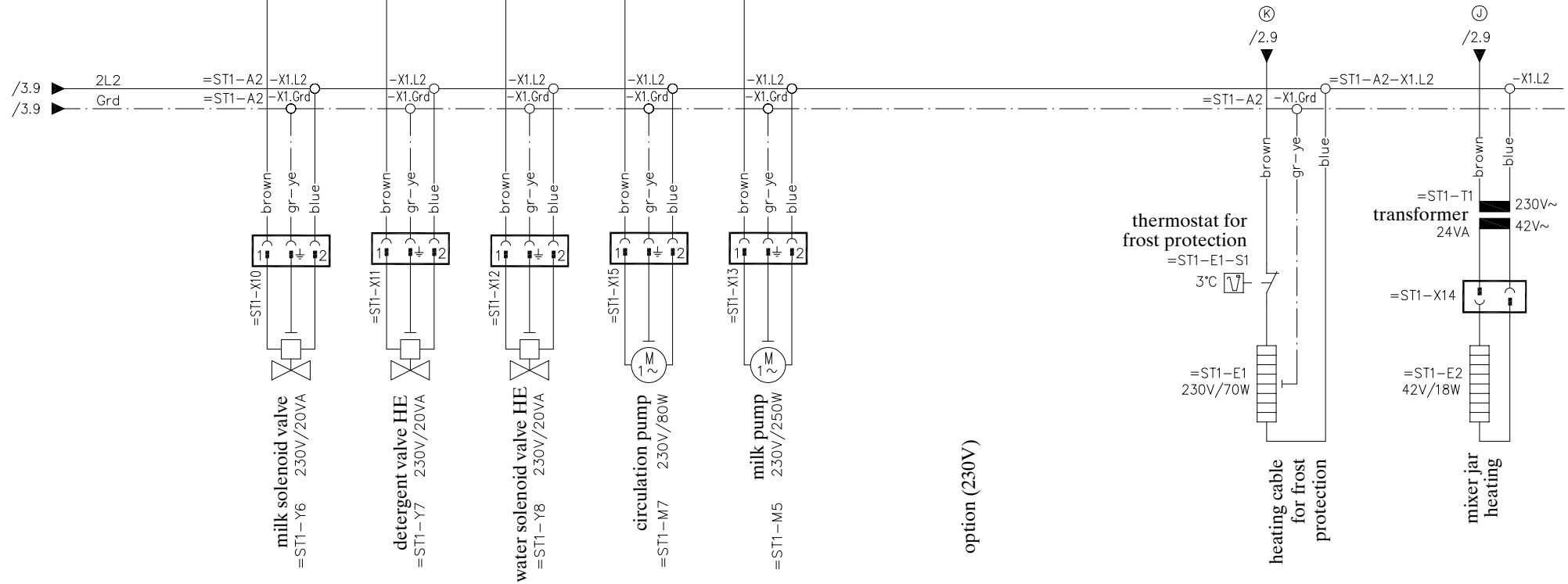
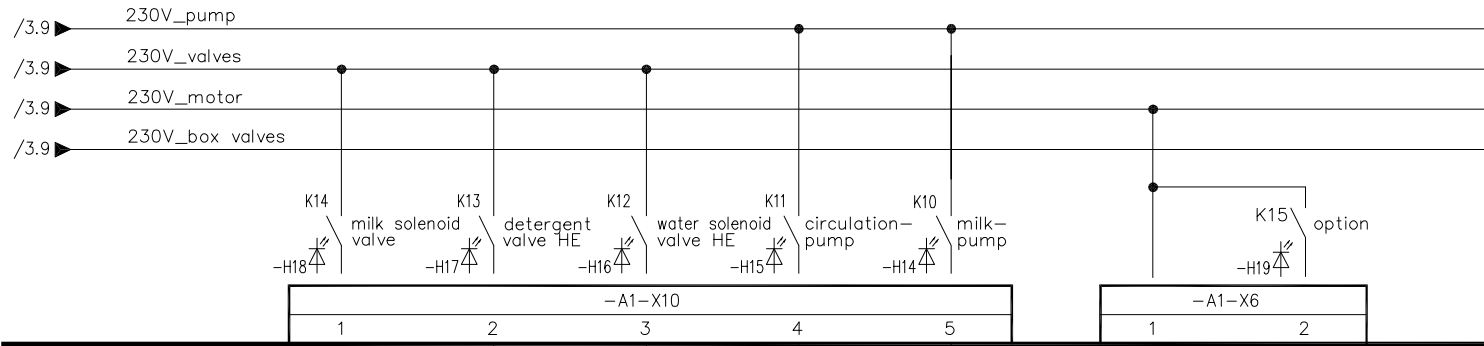

		TAK5-SM2-30-P1 with relay interface Japan	Förster Technik GmbH	Zeichnungs-Nr. PL10229	Blatt 4
			gezeichnet	Versions-Nr. a	von 9 Blätter
Änderung	Ind.	Datum	Name	Datum 02.04.2003 Name jr	Gültig bis:

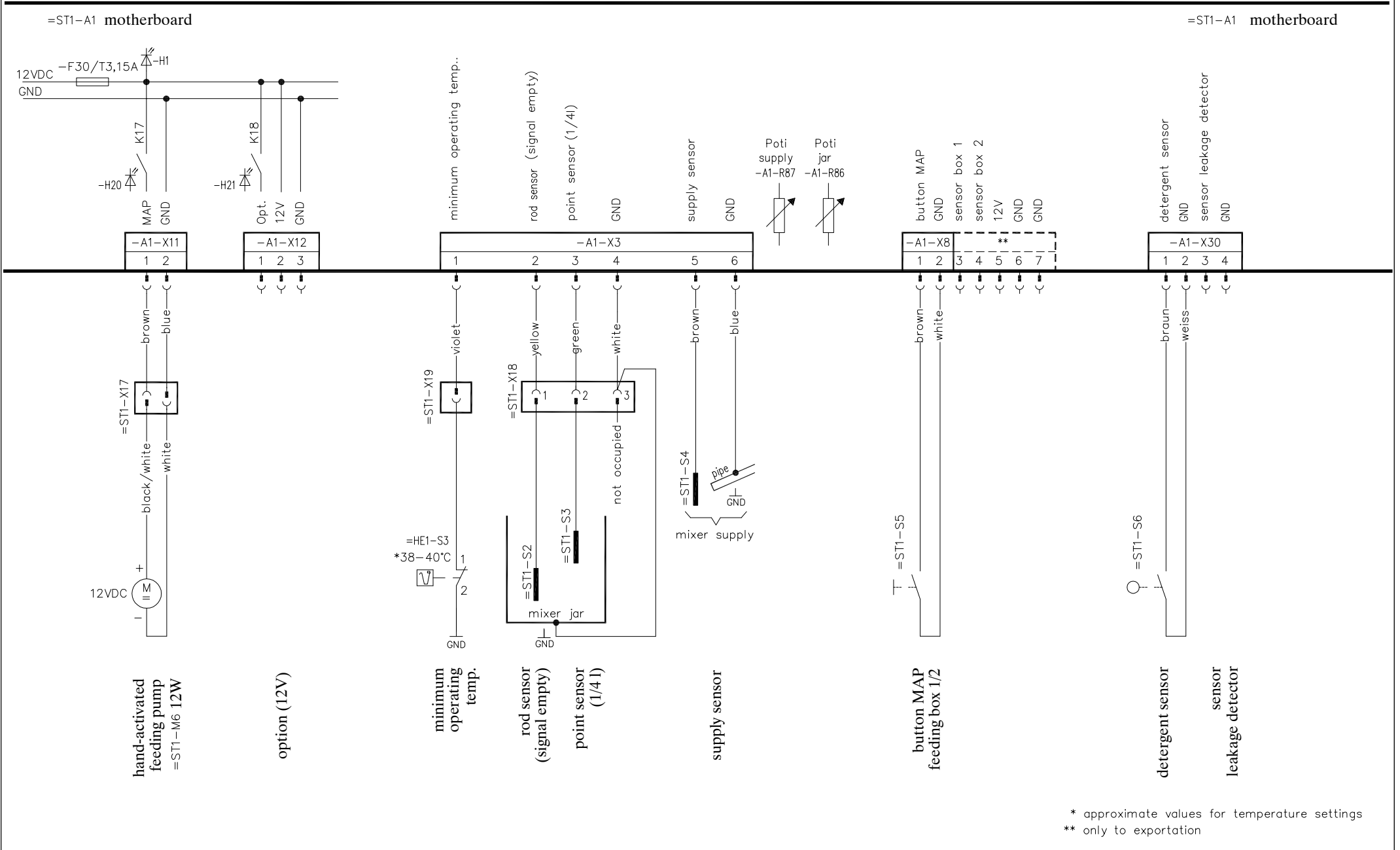

\* approximate values for temperature settings  
 \*\* only to exportation

				TAK5-SM2-30-P1 with relay interface Japan	Förster Technik GmbH	Zeichnungs-Nr. PL10229	Blatt 5
					gezeichnet	Versions-Nr. a	von 9 Blätter
Änderung	Ind.	Datum	Name		Datum 02.04.2003 Name jr	Gültig bis:	

=ST1-A1 motherboard

=ST1-A1 motherboard

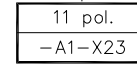
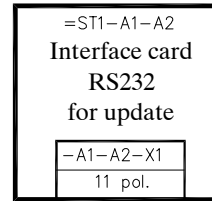

Interface RS232  
 for update

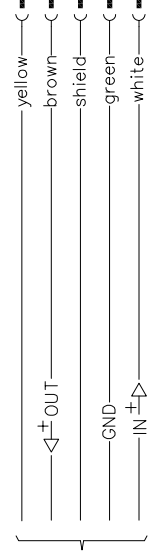
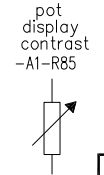
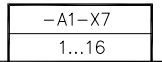
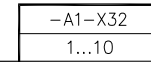
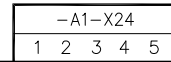

update cable  
 (see sep. diagram)

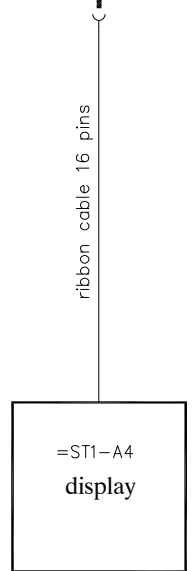
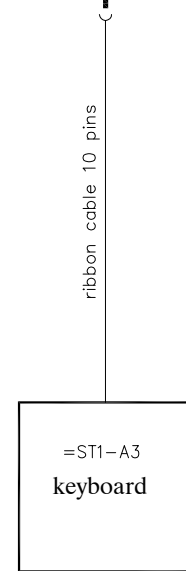

				TAK5-SM2-30-P1 with relay interface Japan	Förster Technik GmbH	Zeichnungs-Nr. PL10229	Blatt 6
						gezeichnet	
Änderung	Ind.	Datum	Name			Datum 02.04.2003 Name jr	Gültig bis:

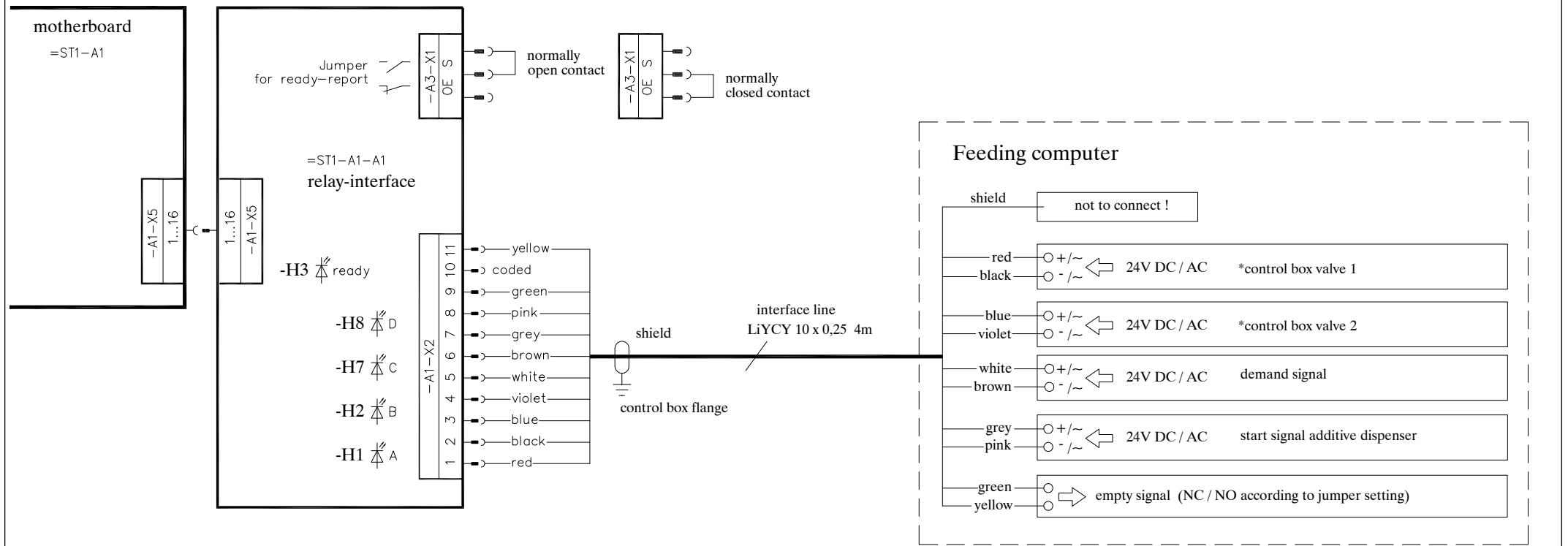

\* not available on each feeding computer ( see user's manual )

				TAK5-SM2-30-P1 with relay interface Japan	Förster Technik GmbH	Zeichnungs-Nr. PL10229	Blatt 7
						Versions-Nr. a	
Änderung	Ind.	Datum	Name		gezeichnet Datum 02.04.2003 Name jr	Gültig bis:	von 9 Blätter

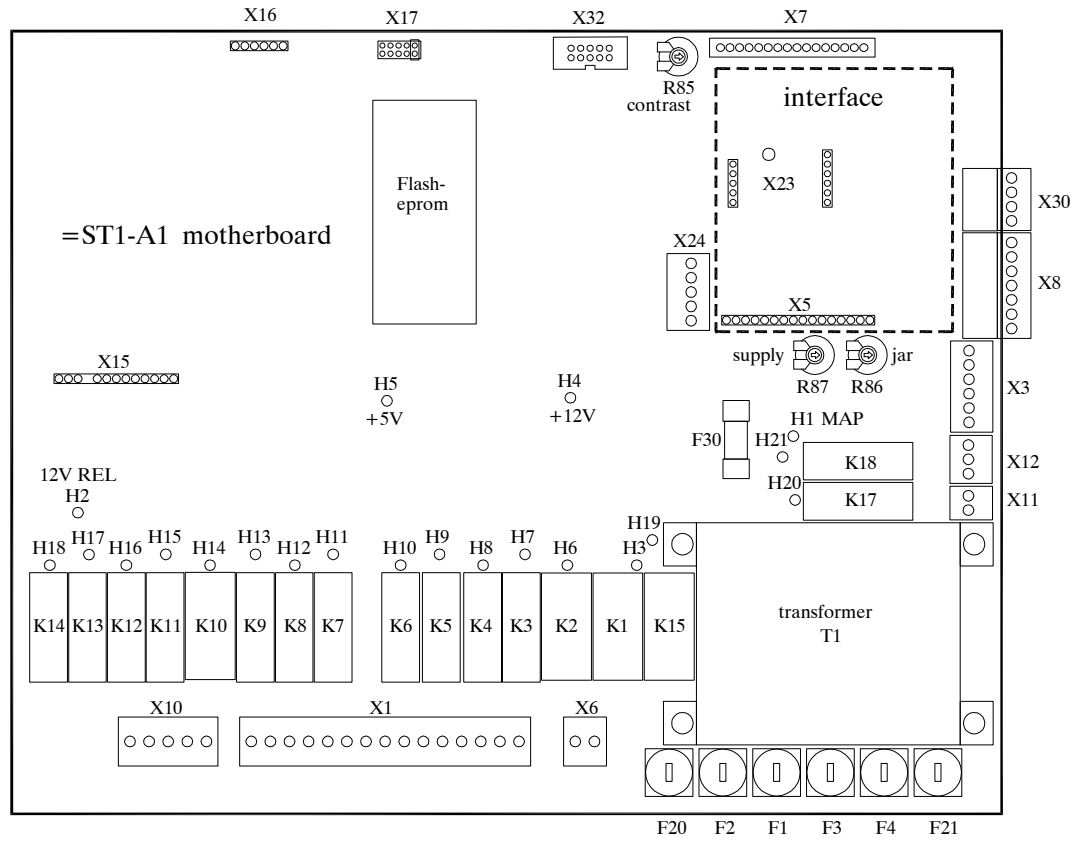

=ST1-A1-A1 relay-interface

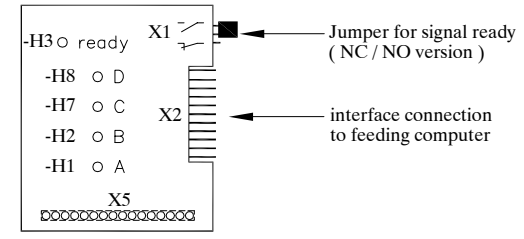

=ST1-A1-A2 interface card RS232 for update

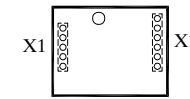

switch on/off powder outlet heating      switch on/off heating cable for frost protection  
 =ST1-A2 distribution board

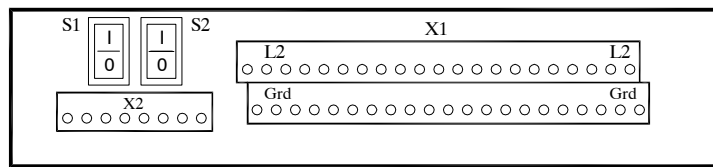

				TAK5-SM2-30-P1 with relay interface Japan		Förster Technik GmbH		Zeichnungs-Nr. PL10229		Blatt 8	
						gezeichnet		Datum 02.04.2003		Versions-Nr. a	
Änderung				Ind. Datum Name		Name jr		Gültig bis:		von 9 Blätter	



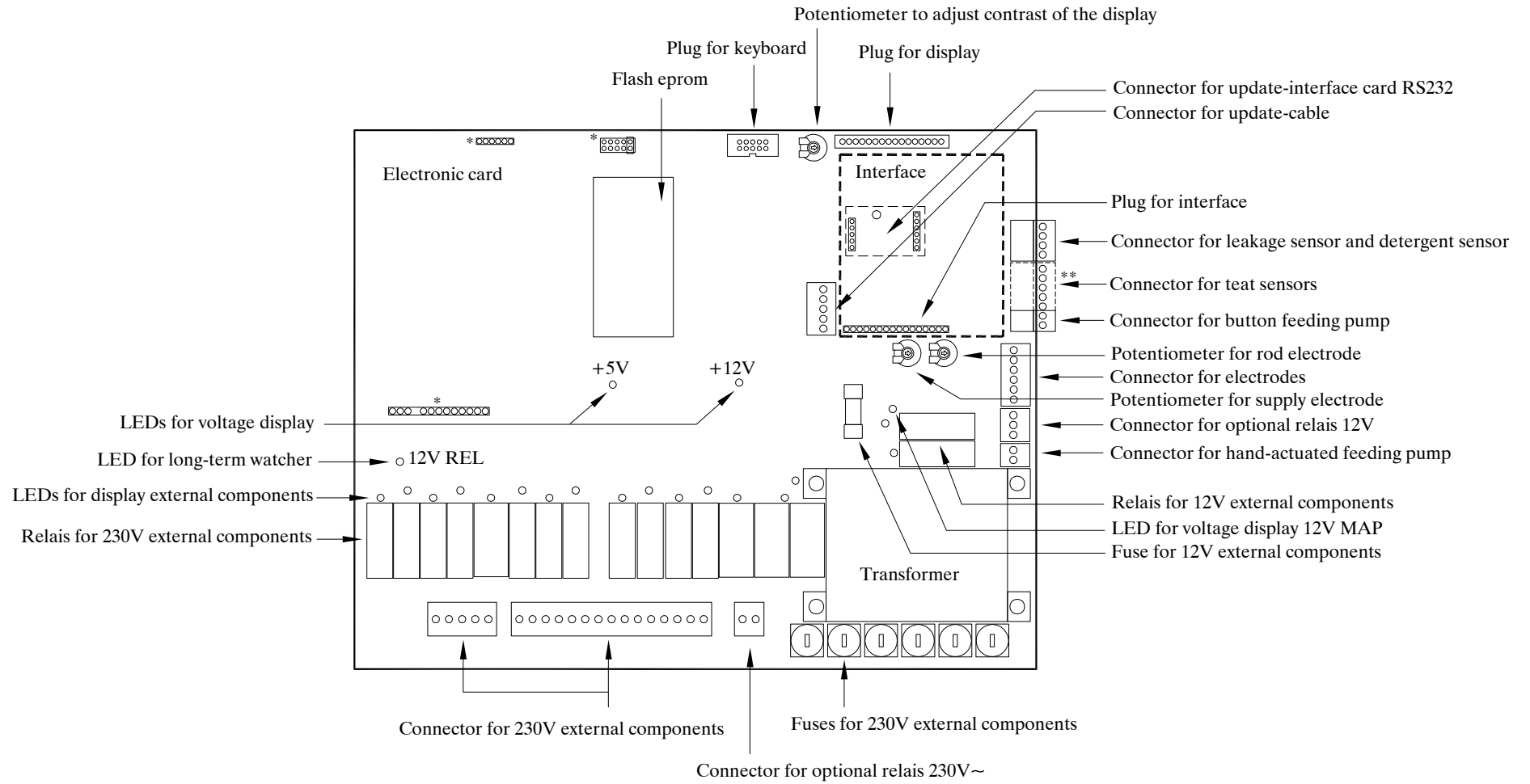

\* Plug for check  
 \*\* depending on the model

				TAK5-SM2-30-P1 with relay interface Japan		Förster Technik GmbH		Zeichnungs-Nr. PL10229		Blatt 9	
						gezeichnet		Datum 02.04.2003		von 9 Blätter	
Änderung				Ind. Datum Name		Name jr		Gültig bis:			