

=WT1 heat exchanger TAK1-SA2-32-M

main
230V/N/PE/50Hz

control unit

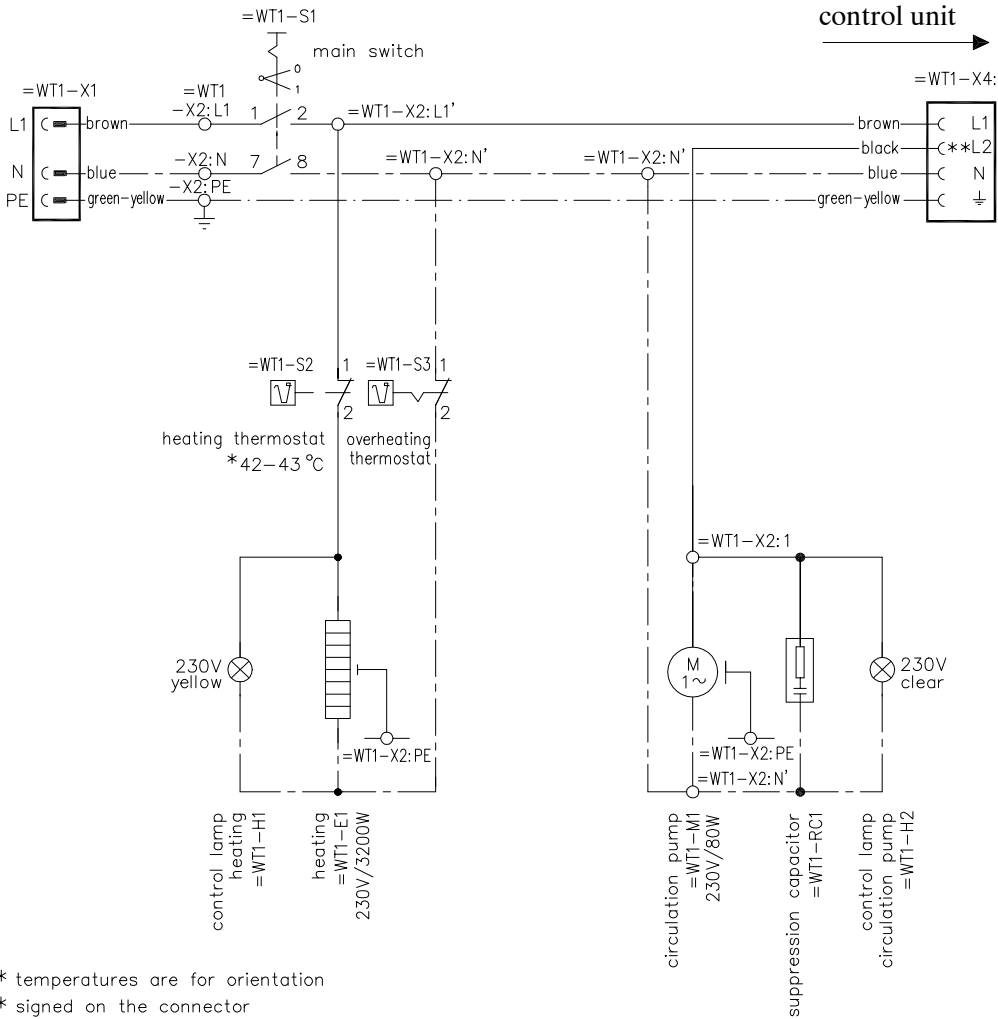

* temperatures are for orientation
** signed on the connector

=WT1 heat exchanger TAK1-SA2-38-M

main
400V,3/N/PE/50Hz

control unit

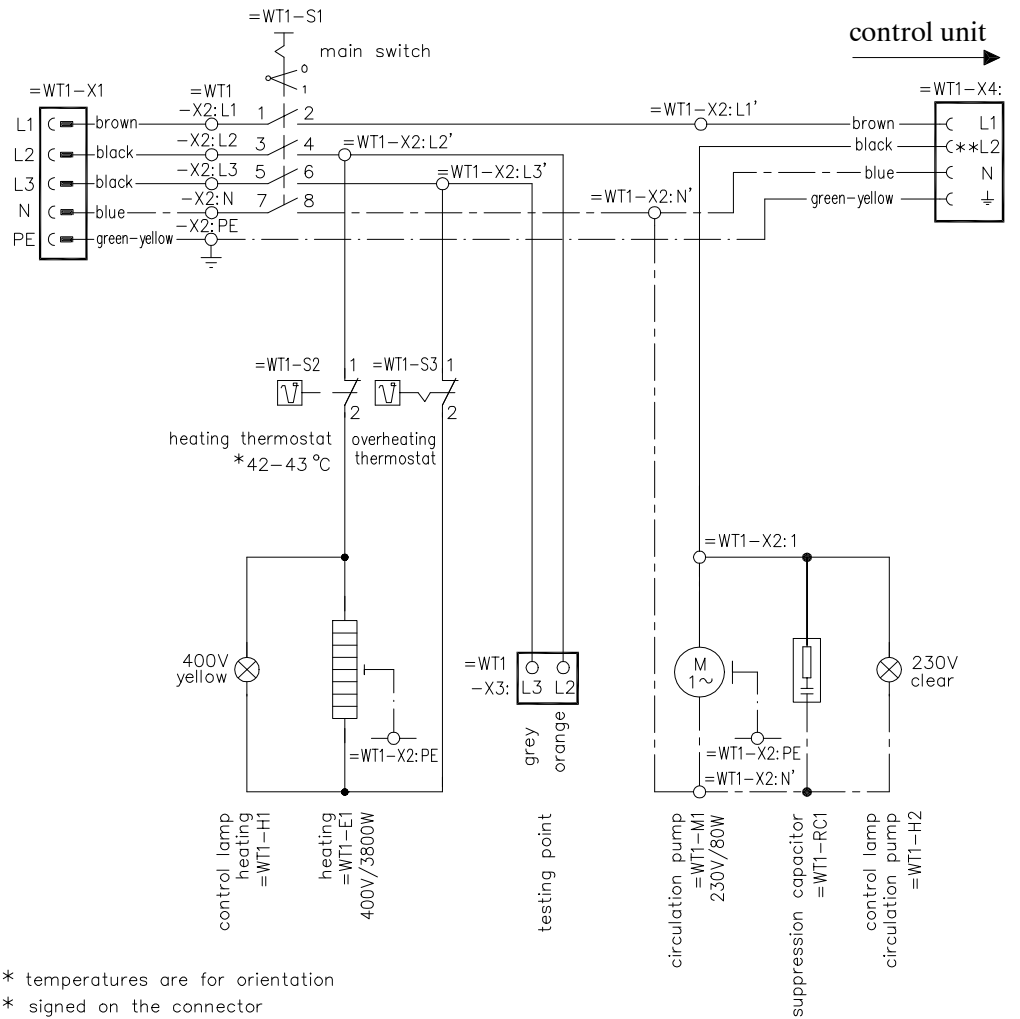

* temperatures are for orientation
** signed on the connector

				TAK1-SA2-32-M TAK1-SA2-38-M with Mikro-identification	Förster Technik GmbH	Zeichnungs-Nr. plan296a	Blatt 1
					gezeichnet Datum 10.11.97	Versions-Nr. 1	von 8 Blätter
Änderung	Ind.	Datum	Name		Name Ruh		

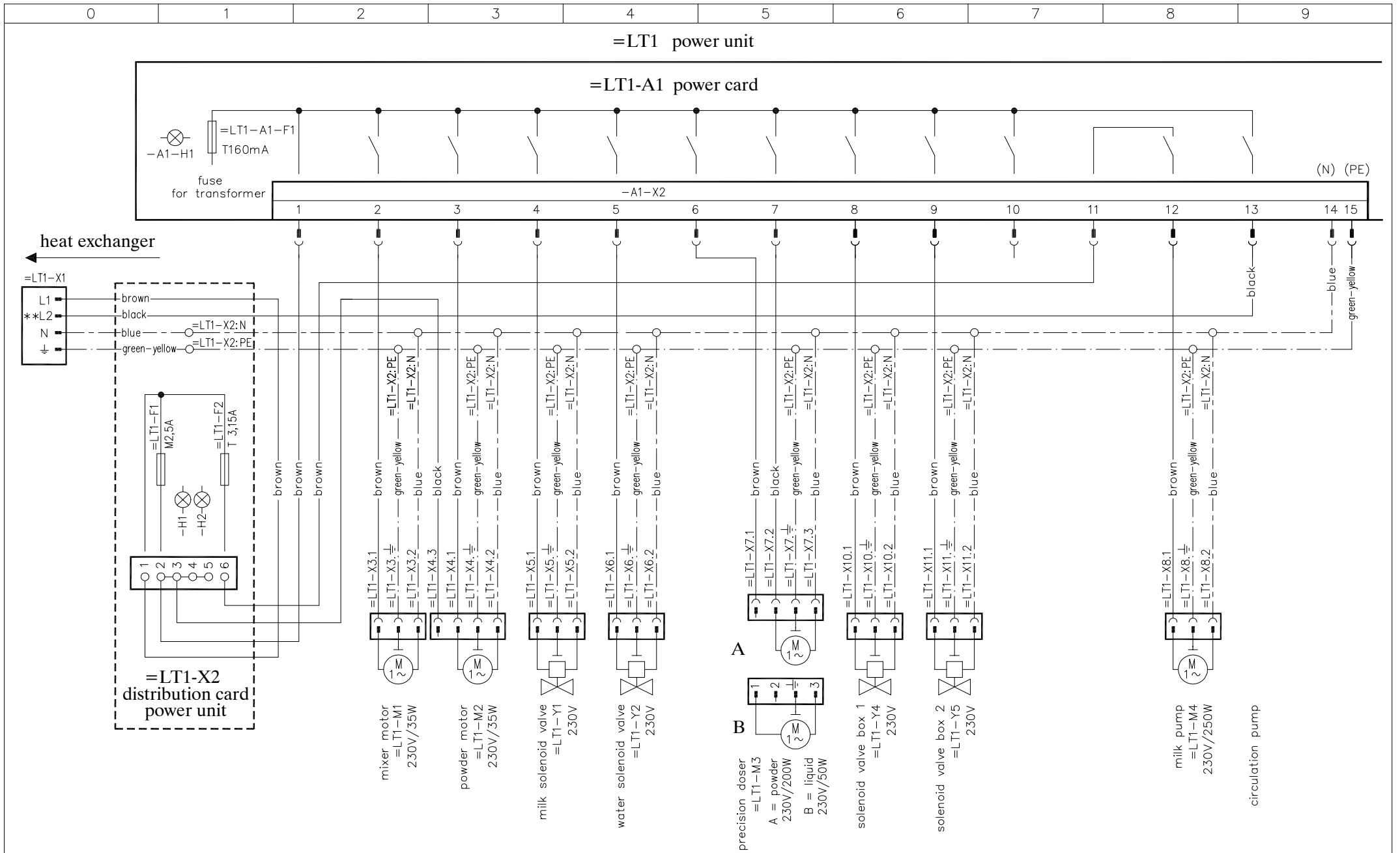

** signed on the connector

				TAK1-SA2-32-M TAK1-SA2-38-M with Mikro-identification	Förster Technik GmbH	Zeichnungs-Nr. plan296a	Blatt 2
					gezeichnet	Datum 10.11.97 Name Ruh	von 8 Blätter
Änderung	Ind.	Datum	Name			Versions-Nr. 1	

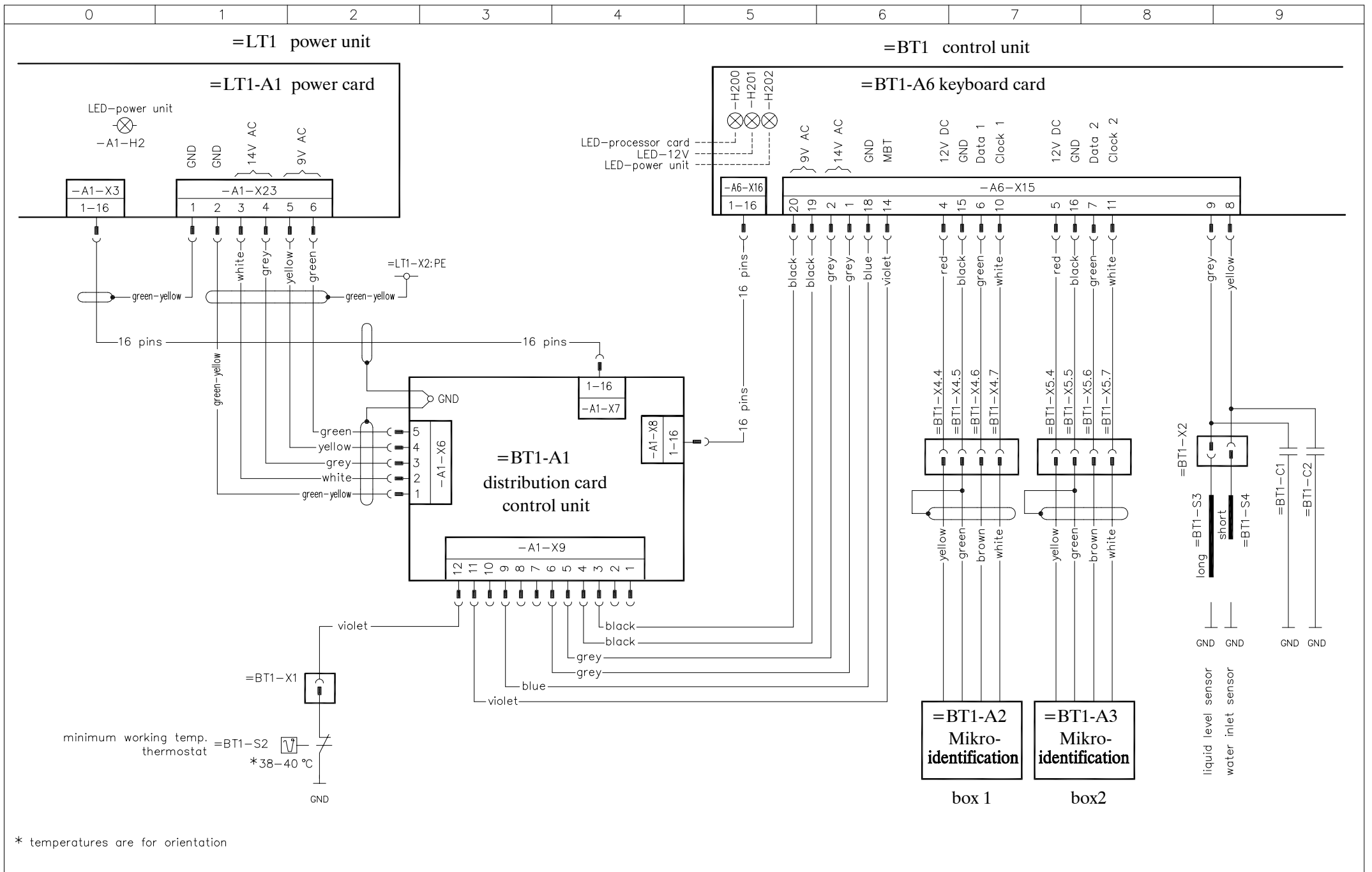

* temperatures are for orientation

				TAK1-SA2-32-M TAK1-SA2-38-M with Mikro-identification	Förster Technik GmbH	Zeichnungs-Nr. plan296a	Blatt 3
					gezeichnet	Datum 10.11.97 Name Ruh	von 8 Blätter
Änderung	Ind.	Datum	Name			Versions-Nr. 1	

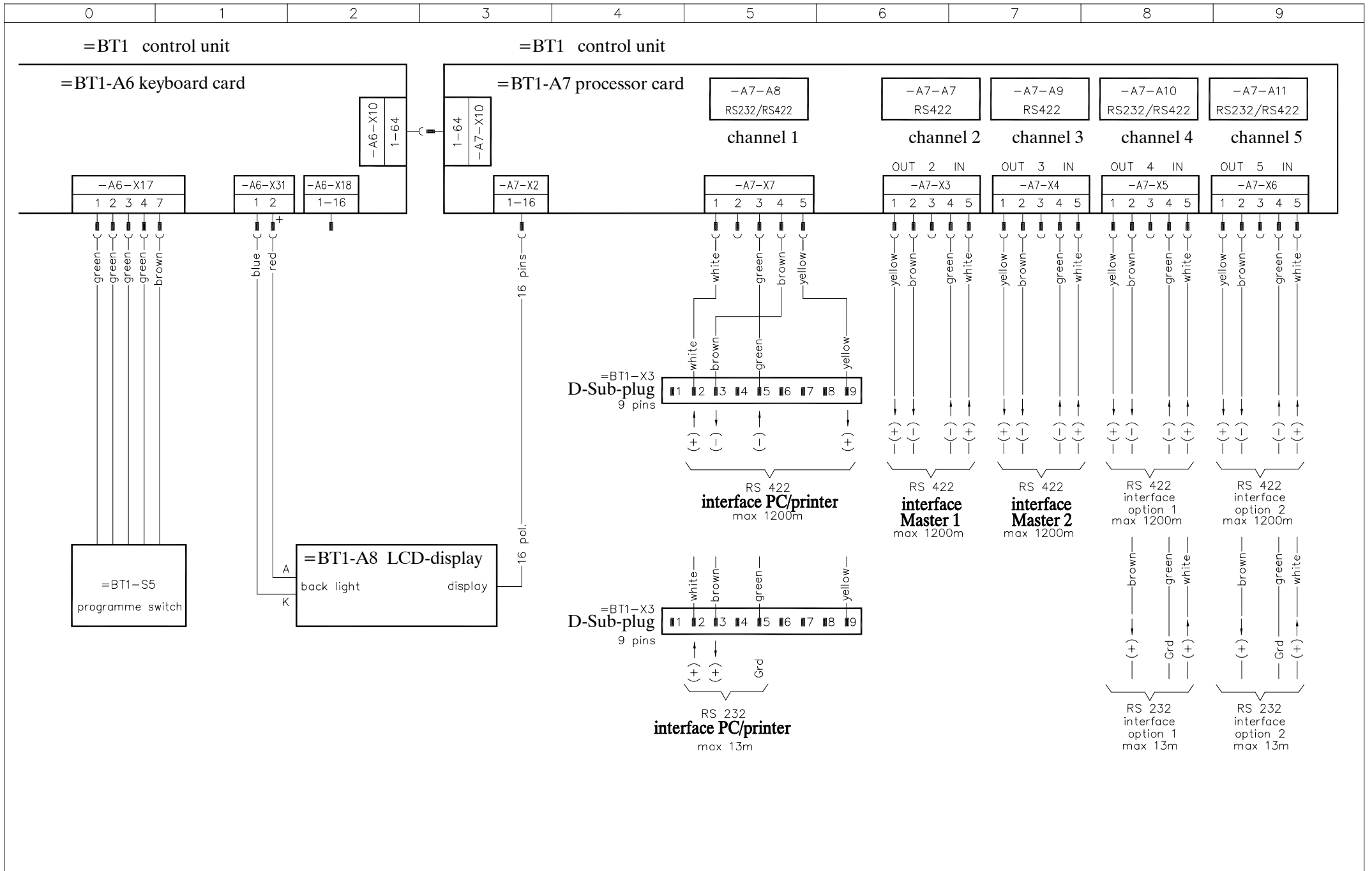

				TAK1-SA2-32-M	Förster Technik GmbH	Zeichnungs-Nr. plan296a	Blatt 4
				TAK1-SA2-38-M		Versions-Nr. 1	
				with Mikro-identification	gezeichnet Datum 10.11.97		von 8 Blätter
Änderung	Ind.	Datum	Name		Name Ruh		

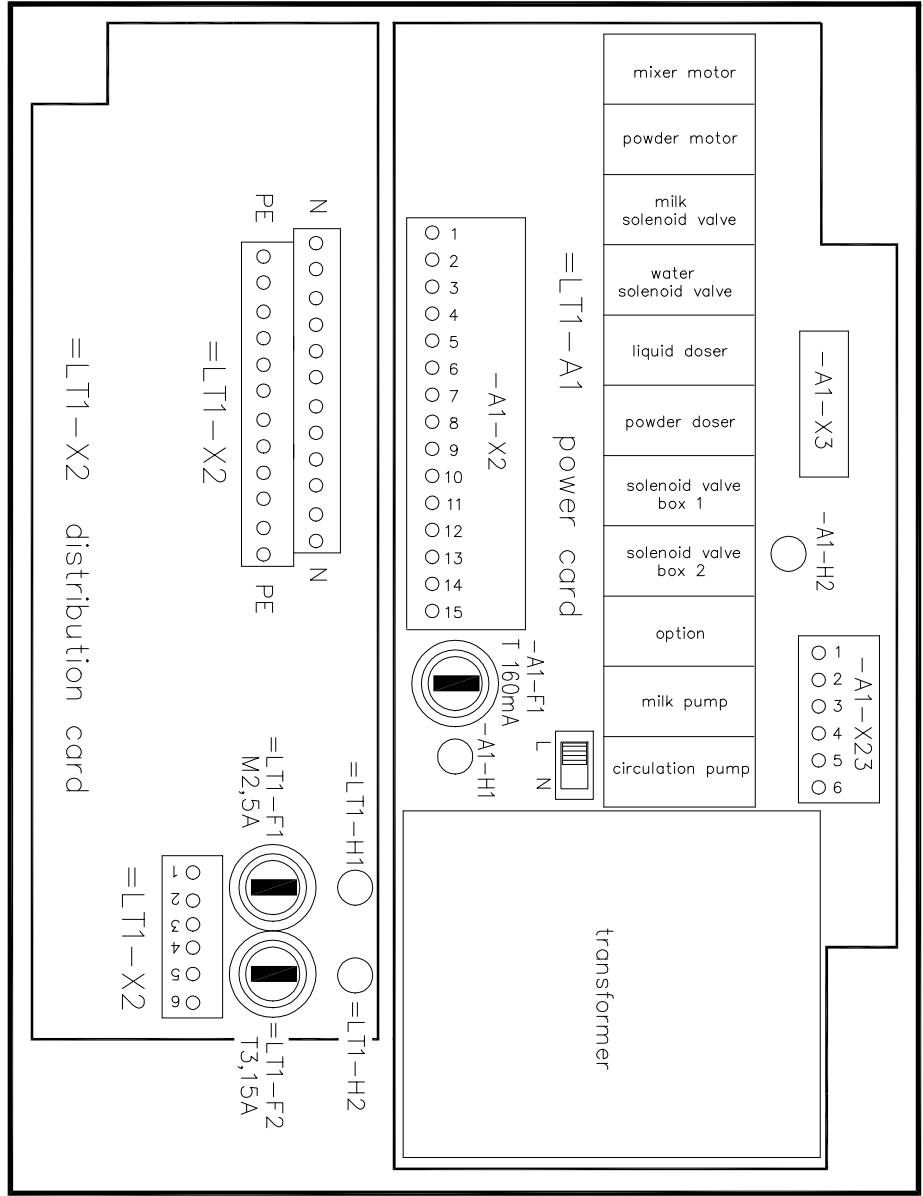

=LT1 power unit

				power unit TAK1-SA2-32-M TAK1-SA2-38-M with Mikro-identification		Förster Technik GmbH		Zeichnungs-Nr. plan296a		Blatt 5	
						gezeichnet		Datum 10.11.97		Versions-Nr. 1	
Änderung		Ind.	Datum	Name							

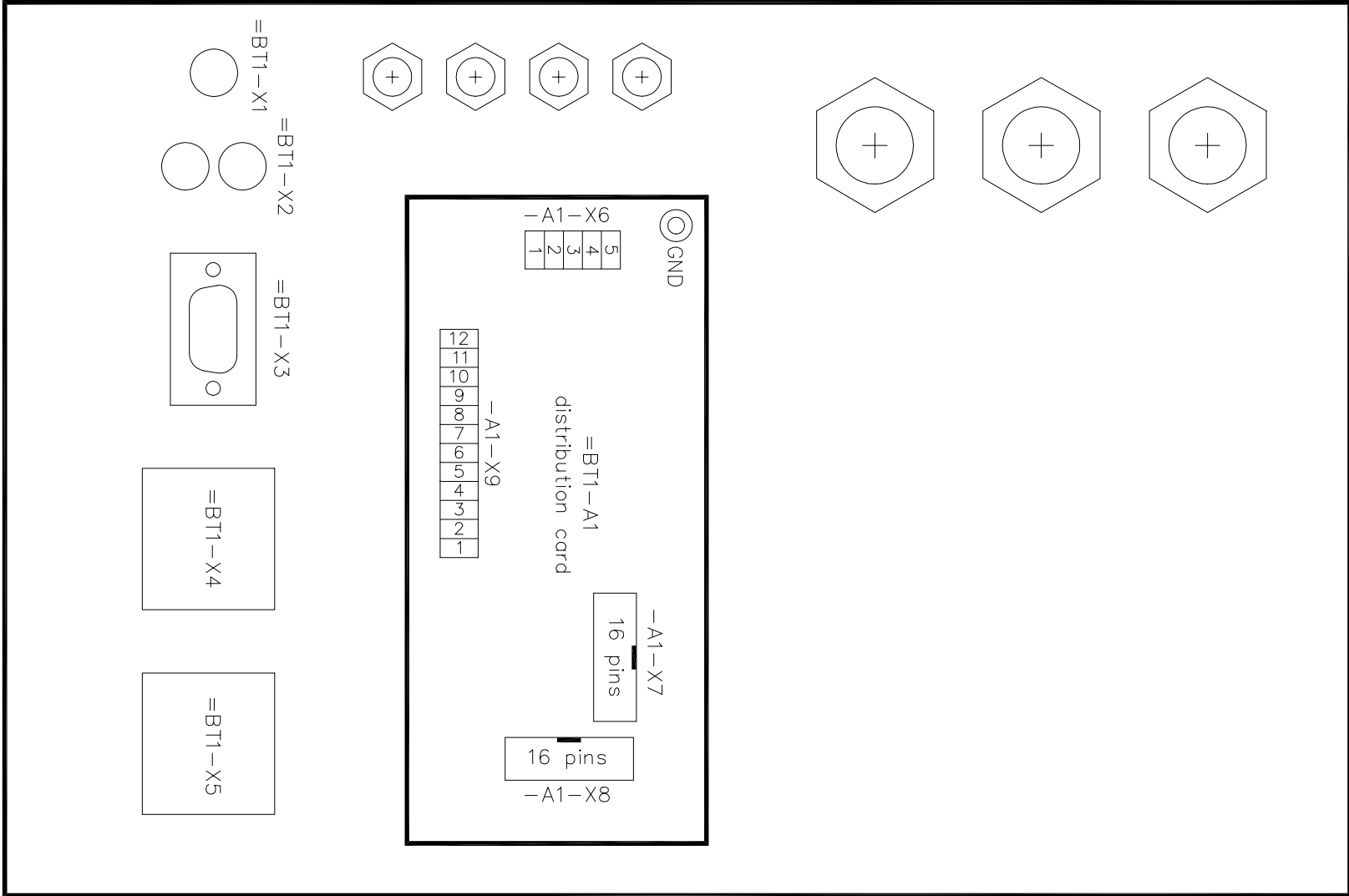

=BT1 control unit

Änderung	Ind.	Datum	Name

control unit
 TAK1-SA2-32-M
 TAK1-SA2-38-M
 wih Mikro-identification

Förster Technik GmbH	Zeichnungs-Nr.	plan296a	Blatt 6
	Versions-Nr.	1	
gezeichnet	Datum	10.11.97	von 8 Blätter
	Name	Ruh	

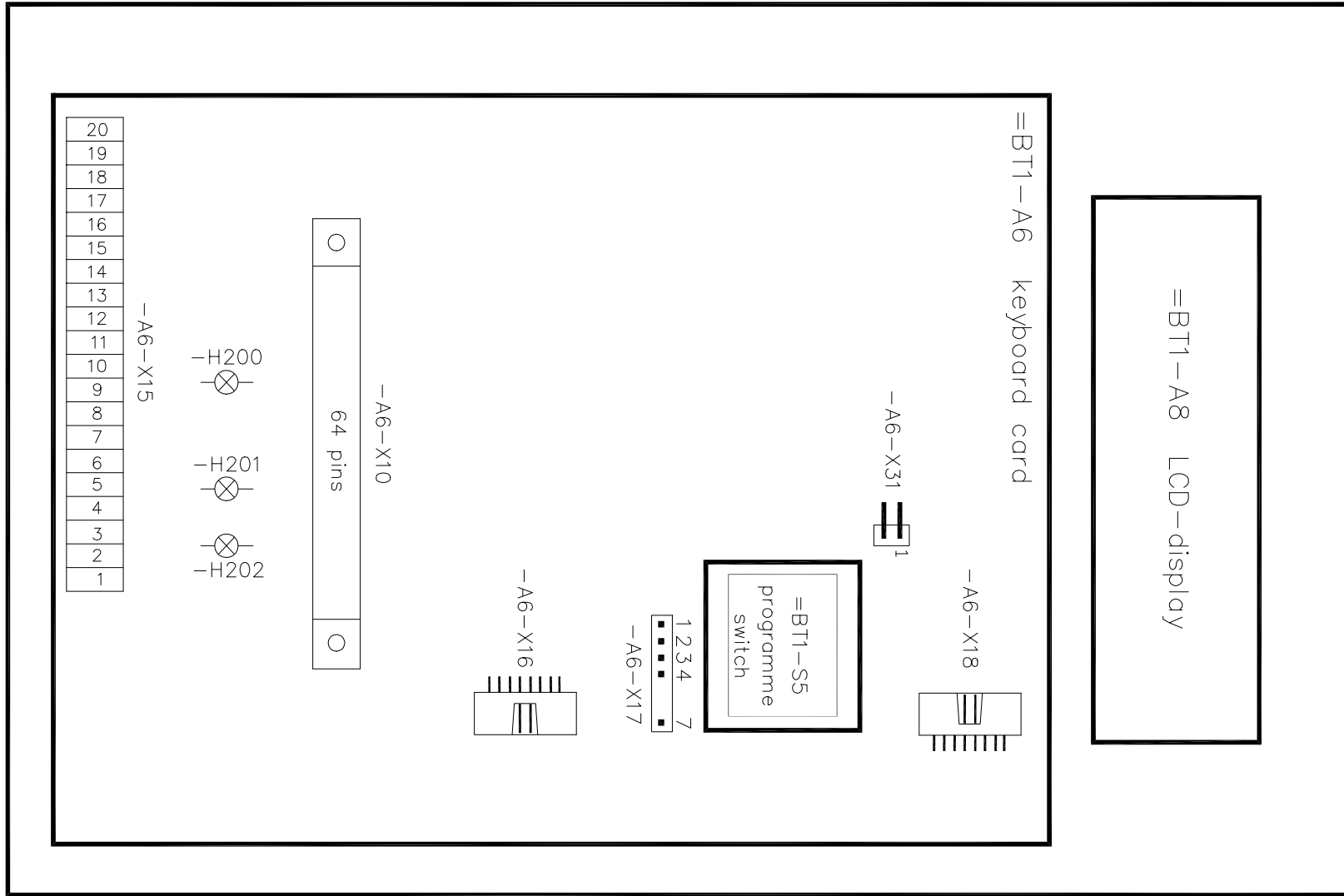

Änderung	Ind.	Datum	Name

control unit
 TAK1-SA2-32-M
 TAK1-SA2-38-M
 with Mikro-identification

Förster Technik GmbH gezeichnet	Datum 10.11.97
	Name Ruh

Zeichnungs-Nr. plan296a	Blatt 7
Versions-Nr. 1	
	von 8 Blätter

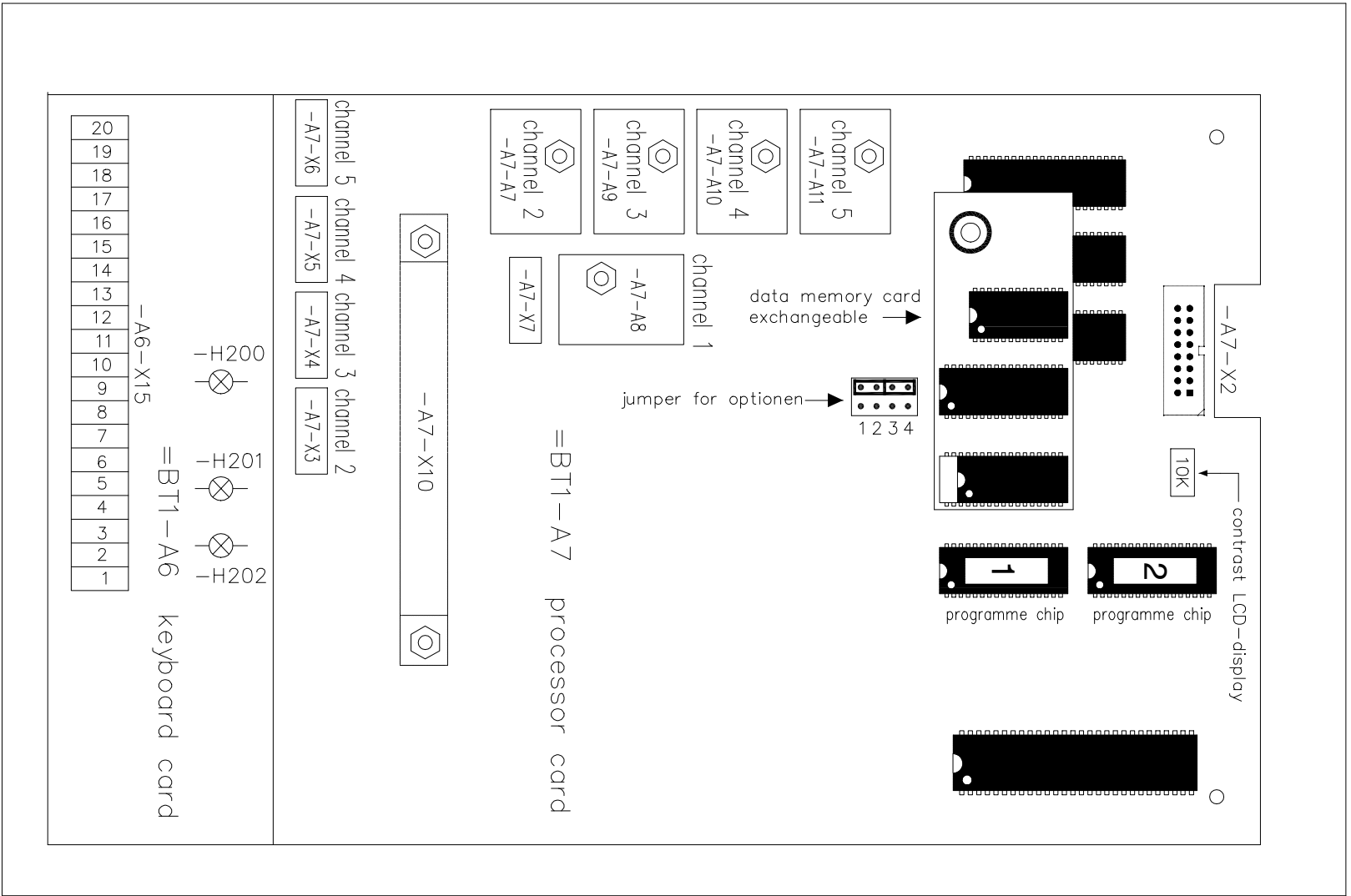

Änderung	Ind.	Datum	Name

control unit
 TAK1-SA2-32-M
 TAK1-SA2-38-M
 with Mikro-identification

Förster Technik GmbH	
gezeichnet	Datum 10.11.97
	Name Ruh

Zeichnungs-Nr.	plan296a
Versions-Nr.	1

Blatt	8
von	8 Blätter